

CAT/25/2.2-EE

bepco

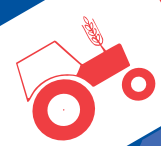

TRACPIECES



REPLACEMENT PARTS SUITABLE FOR ·
Case-IH & David Brown

**AGRIPIECES**Tel.: +(33) 553 96 31 25
Fax: +(33) 553 68 03 72**Agripieces Sud-Ouest Distribution s.a.**

Zone Industrielle Agen Boe, B.P. 5 - F-47240 Bon-Encontre (France)

**TRACPIECES**Tel.: +(33) 327 83 53 12
Fax: +(33) 327 81 23 13**Tracpieces France s.a.**

P.A. Fontaine Notre Dame - F-59406 Cambrai (France)

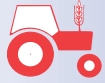
**TRACPIECES**Tel.: +(32) 085 27 80 80
Fax: +(32) 085 27 80 81**Tracpieces Benelux s.a.**

36, rue J. Delhalle - B-4520 Wanze (Belgique/Belgie)

Tel.: +(44) 12 99 25 2200
Fax: +(44) 12 99 25 2201**Bepco Group**

Bepco House - Hartlebury Trading Estate - Worcestershire - DY104JB Hartlebury (UK)

Tel.: +(44) 12 99 25 2270
Fax: +(44) 800 21 6553**Bepco (U.K) Ltd.**

Bepco House - Hartlebury Trading Estate - Worcestershire - DY104JB Hartlebury (UK)

**TRACPIECES**Tel.: +(49) 5251 77 903 66
Fax: +(49) 5251 77 903 77**Tracpieces Ersatzteile GmbH**

Steinbruchweg, 13 - D-33106 Paderborn (Deutschland)

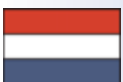
**TRACPIECES**Tel.: +(31) 413 293 975
Fax: +(31) 413 294 087**Tracpieces Nederland b.v.**

Den Dolvert, 10 - NL-5473 GP Heeswijk-Dinther (Nederland)

**EURESA**Tel.: +(34) 93 381 00 62
Fax: +(34) 93 391 33 45**Europa de Recambios s.a.**

Av. M. Fernandez Marquez, s/n Nave 4, 1 ° - 08930 San Adrian del Besos (España)

Tel.: +(61) 397 96 54 22
Fax: +(61) 397 96 52 51**Bepco Australasia (Head office)**

Factory 5, 1 Melverton Drive - Hallam 3803 Victoria (Australia)

Tel.: +(27) 11 3975386/9
Fax: +(27) 11 3973039**Bepco South Africa (Pty) Ltd.**

CNR Rudo Nell / Kelly St. - Jet Park Boksburg, Johannesburg (South Africa)



CASE-IH PARTS

Freinage - Brakes - Bremsen - Remmen - Frenos

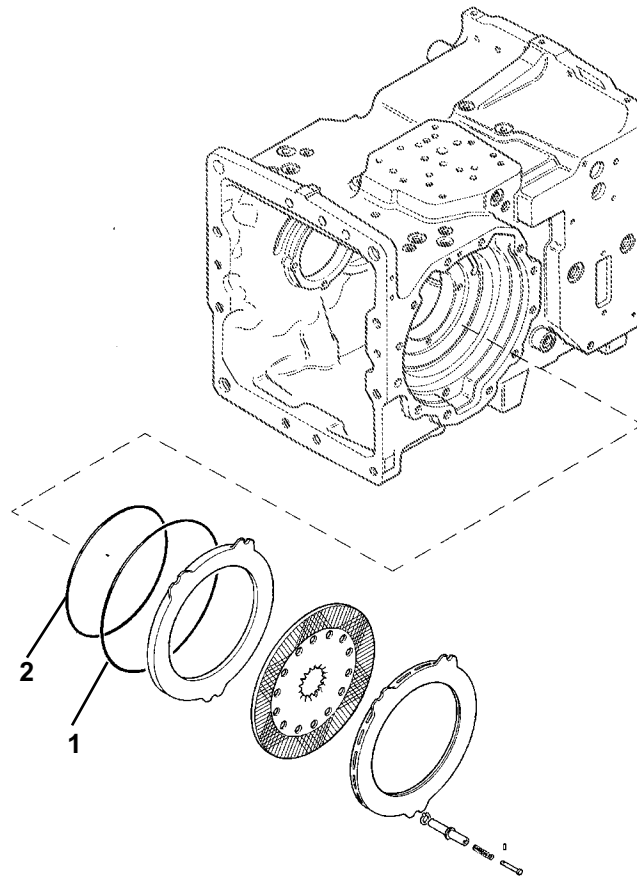

|  | Fig. | Part N° | OEM | |
|--|------|------------------|--|--|
| 2470, 2670, 5120, 5130, 5140, 5150, 5220, 5230, 5240, 5250, MX80C, MX90C, MX100, MX100C, MX110, MX120, MX135 | 1 | 25/416-27 | 238-5277 A190067 | Dia. Int Ø 292mm x Ep. 3.17mm In. Dia. Ø 292mm x Tic. 3.17mm Dia. Inn. Ø 292mm x T. 3.17mm Dia. Bin. Ø 292mm x di. 3.17mm Dia. Int. Ø 292mm x Gr. 3.17mm |
| | 2 | 25/416-28 | 238-5273 A175180 A178874 A75156 70924144 | Dia. Int Ø 248mm x Ep. 3.17mm In. Dia. Ø 248mm x Tic. 3.17mm Dia. Inn. Ø 248mm x T. 3.17mm Dia. Bin. Ø 248mm x di. 3.17mm Dia. Int. Ø 248mm x Gr. 3.17mm |

Les références des pièces sont indicatives.
Nos pièces ne sont pas d'origine.

Part numbers are quoted for reference purposes only.
Our parts and accessories are not original.





CASE-IH PARTS

Calandres - Front grills - Scheinwerferrahmen - Roosteren - Rejillas frontales

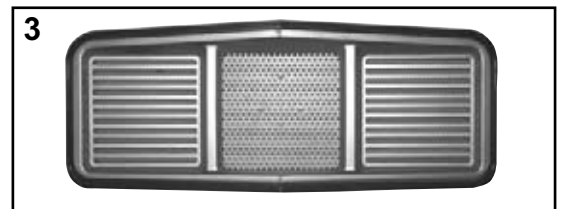
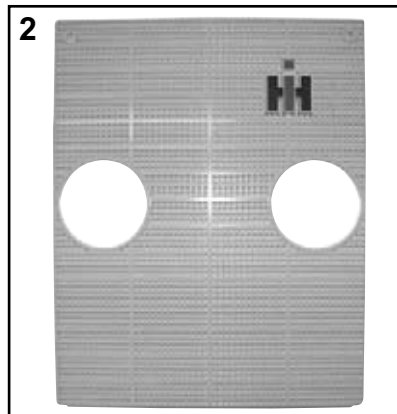
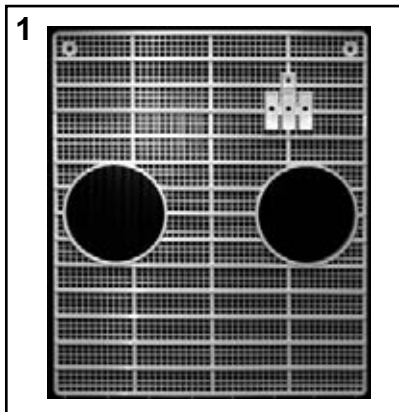

|  | Fig. | Part N° | OEM | Description - Description - Beschreibung - Omschrijving - Descripción |
|---|------|-----------|------------|--|
| 323, 353, 383, 423, 453 | 1 | 25/841-16 | 786862R2 | Calandre en plastique Plastic grill Kunststoff Gitter Plastic rooster Calandra de plástico |
| 523, 624, 724, 824 | 2 | 25/841-17 | 3057444R2 | Calandre en métal Iron grill Metall Gitter Metalen rooster Calandra metálica |
| 644, 844, 844S, 844XL, 856XL, 946, 955, 955XL, 956, 956XL, 1046, 1055, 1055XL, 1056, 1056XL, 1246 | 3 | 25/841-18 | 3402639R91 | Calandre en plastique Plastic grill Kunststoff Gitter Plastic rooster Calandra de plástico |
| | 4 | 25/841-19 | 3141785R91 | Calandre en plastique Plastic grill Kunststoff Gitter Plastic rooster Calandra de plástico |

Les références des pièces sont indicatives.
Nos pièces ne sont pas d'origine.

Part numbers are quoted for reference purposes only.
Our parts and accessories are not original.





CASE-IH PARTS

**Relais (éclairage) - Light relay - Schalter (Beleuchtung) -
Relais verlichting - Solenoides de luz**

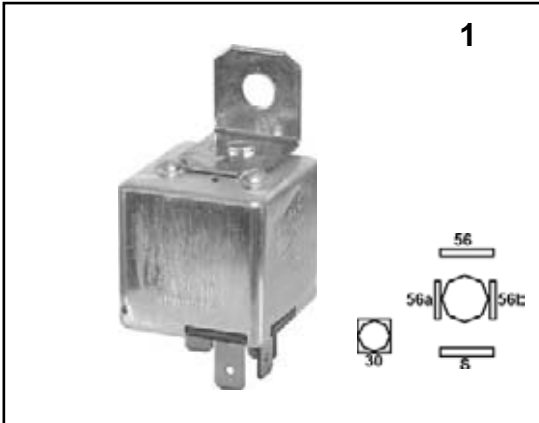

|  | Fig. | Parts N° | OEM | |
|--|------|------------------|-----------|------------|
| 433, 433E, 433V, 440, 485XL, 495XL, 533, 533E, 533V, 540, 585XL, 595XL, 633, 633E, 633V, 640, 685XL, 695XL, 733, 733E, 740, 743, 743XL, 745S, 745XL, 785XL, 795XL, 833, 833E, 840, 844S, 844XL, 845, 845XL, 856XL, 885XL, 895XL, 933, 940, 956, 956XL, 995XL, 1056, 1056XL, 1255, 1255XL, 1455, 1455XL, 3210, 3220, 3230, 4210, 4220, 4230, 4240, 5120, 5130, 5140, 5220, 5230, 5240, 5250, C50, C60, C70, C80, C90, CX50, CX60, CX70, CX80, CX90, CX100, MX80C, MX90C, MX100, MX100C, MX110, MX120, MX135, MX150, MX170 | 1 | 25/965-25 | 1502351C1 | 12V 2x150W |
| 3210, 3220, 3230, 3230, 4210, 4220, 4230, 4240, 5120, 5130, 5140, 5150, 5220, 5230, 5240, 5250, CX50, CX60, CX70, CX80, CX90, CX100, MX100, MX110, MX120, MX135 | 2 | 25/965-29 | 1987452C1 | 12V 70A |





CASE-IH PARTS

Pont avant "ZF" - "ZF" front axle - Vorderachse ZF - Vooras ZF - Eje delantero ZF

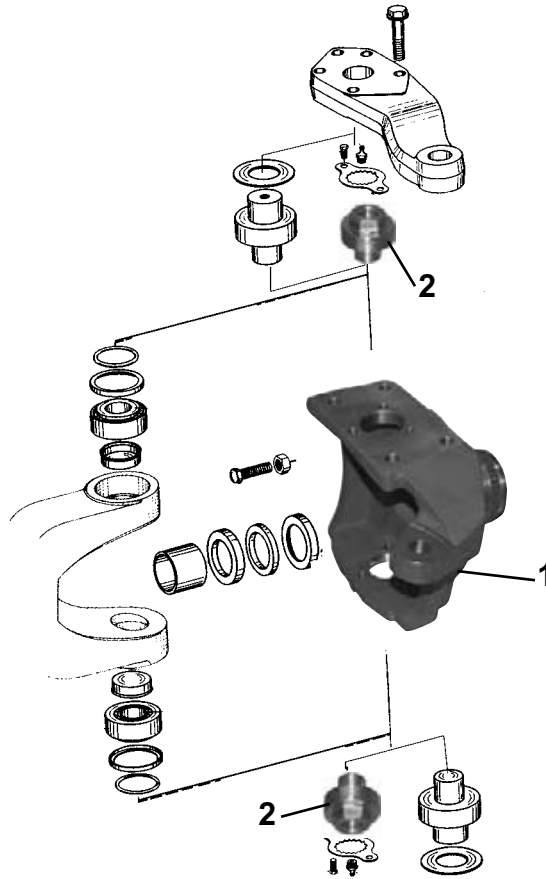

|  | | 1 | 2 |
|--|---------|----------------------------------|---------------------------------|
| Case-IH (Europe) | | | |
| 533, 633, 733, 833, 933 540, 640, 740, 840, 940 | APL1251 | | 25/6450-12 (321588R2) |
| 644, 743, 743XL, 744, 745S, 745XL, 844, 844S, 844XL, 856XL | APL1351 | 25/6400-50 (3230955R1) | |
| Case-IH (UK) | | | |
| 258, 268, 278, 485XL, 584, 585, 585XL, 684, 685, 685XL, 784, 785, 785XL, 884, 885, 885XL, 85Hydro | APL1351 | 25/6400-50 (3230955R1) | 25/6450-12 (321588R2) |

Les références des pièces sont indicatives.
Nos pièces ne sont pas d'origine.

Part numbers are quoted for reference purposes only.
Our parts and accessories are not original.





CASE-IH PARTS

FREINAGE (BAIN D'HUILE) - BRAKES (OIL BATH) - BREMSEN (ÖLBAD) - REMMEN (OLIEBAD) - FRENOS (EN BAÑO DE ACEITE)

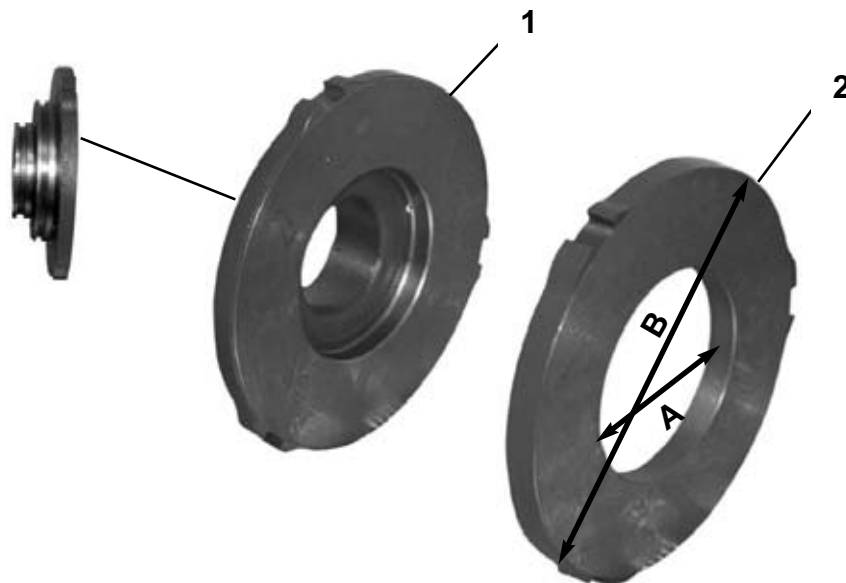

|  | Fig. | Parts N° | Oem | Remarque / Observation Anmerkung / Opmerking Observación |
|---|------|------------------|-----------|--|
| 956, 956XL, 1056, 1056XL | 1 | 25/417-46 | 3402717R2 | (A) Ø135mm (B) Ø260mm |
| | 2 | 25/423-46 | 3220455R2 | |





CASE-IH PARTS

FREINAGE (BAIN D'HUILE) - BRAKES (OIL BATH) - BREMSEN (ÖLBAD) - REMMEN (OLIEBAD) - FRENOS (EN BAÑO DE ACEITE)

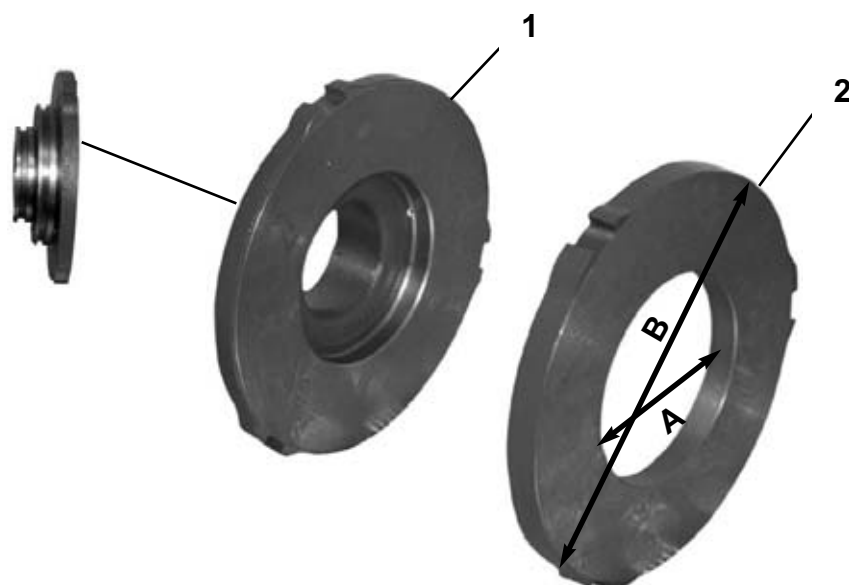

|  | Fig. | Parts N° | Oem | Remarque / Observation Anmerkung / Opmerking Observación |
|---|------|------------------|-----------|--|
| 956, 956XL, 1056, 1056XL | 1 | 25/417-46 | 3402717R2 | (A) Ø135mm (B) Ø260mm |
| | 2 | 25/423-46 | 3220455R2 | |





CASE-IH PARTS

Câbles d'embrayage - Clutch cables - Kupplungsseil -
Koppelingskabels - Cables de embrague



|  | Fig. | Parts N° | Oem | Observation |
|---|------|------------------|------------------------|---|
| 743XL, 745XL, 844XL, 845XL, 856XL, 955XL, 956, 956XL, 1056, 1055XL, 1056XL | 1 | 25/198-18 | 3404859R1 3234644R1 | Lg. 695mm |
| 1255XL, 1455XL | 2 | 25/198-19 | 3404860R1 3401658R1 | Avancement Main disc Kupplungsbedienung Rijplaat Disco principal Lg. 725mm |
| | 3 | 25/198-20 | 3404861R1 | Prise de force PTO Gelenkwellen Aftakas TDF Lg. 933mm |

Les références des pièces sont indicatives.
Nos pièces ne sont pas d'origine.

Part numbers are quoted for reference purposes only.
Our parts and accessories are not original.





CASE-IH PARTS

**Couronne de démarrage & volant moteur - Ring gear & flywheel -
Starterkranz & Vliegwiel - Starterkrans & vliegwiel-
Corona de volante & volante motor**

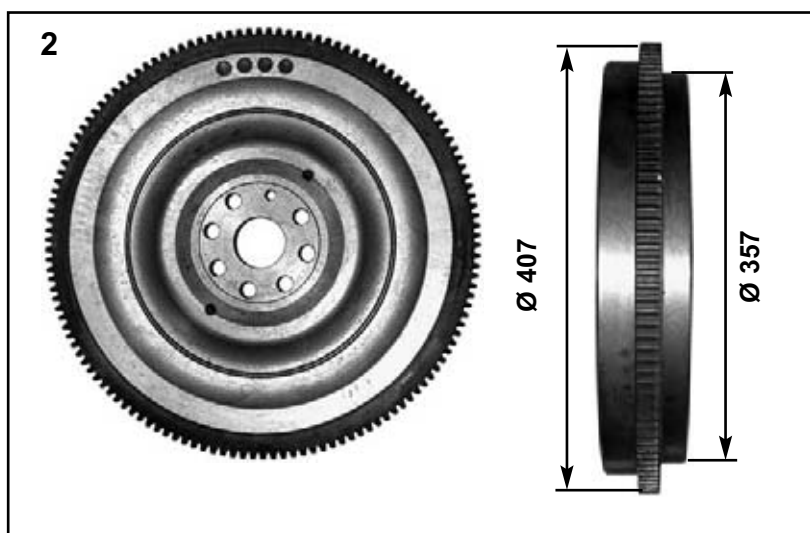
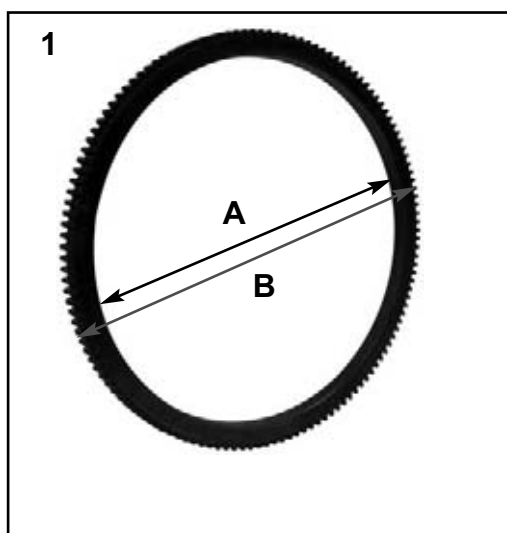

|  | Fig. | Part N° | Oem | |
|--|------|-----------------|------------|--|
| 743, 745S, 844, 844S, 844XL, 845, 845XL, 856XL, 955, 955XL, 956, 956XL, 1055, 1055XL, 1056, 1056XL, 1255, 1255XL, 1455, 1455XL | 1 | 25/15-9 | 3144607R1 | 134Z (A) Int. Ø357 (B) Ext. Ø407 |
| 454, 553, 644, 654, 724, 743, 743XL, 744, 745S, 745XL, 824, 845, 946, 1046, 1246, 2400 | | 25/15-23 | 3055133R1 | 129Z (A) Int Ø357 (B) Ext Ø390.4 |
| 743, 745S, 844, 844S, 844XL, 845, 845XL, | 2 | 25/296-6 | 3144651R92 | 134Z |





CASE PARTS

Vérin à gaz - Gas struts - Gasfedern - Gascilinders - Amortiguadores



|  | Fig. | Part N° | OEM | |
|---|------|------------|--------------|------------|
| CS68, CS75, CS78, CS86, CS94, CS100, CS110, CS120, CS130, CS150, CVX120, CVX130, CVX150, CVX170, CVX1135, CVX1145, CVX115, CVX1170, CVX1190 (A) CS48, CS52, CS58, CS63, CS68, CS75 (B) CS68, CS75 (C) CS68, CS75, CS78, CS86, CS94 (D) | 1 | 25/870-103 | 1-99-976-066 | L : 485mm |
| CS78, CS86, CS94, CS100, CS110, CS120, CS130, CS150, CVX120, CVX130, CVX150, CVX170 (E) | 2 | 25/871-43 | 1-99-976-036 | L : 275 mm |

(A) Glace arrière et vitre latéral - Rear glass and side window - Cristal trasero y lateral

(B) Pare-brise - Windscreen - Frontscheibe - Voorruit - Parabrisa

(C) Pare-brise et vitres latérales - Windscreen and side windows - Front - u. Seitenscheibe - Voorruit en zijruiten - Parabrisa y cristales laterales

(D) Glace arrière cabine étroites - Rear glass cab narrow - Heckscheibe Schalspurschlepper - Achterruit smalle cabineCristales trasero cabina estrecha

(E) Toit - Roof - Dach - Dakkluk - Techo

Raclettes d'essuie-glace - Wiper blades - Scheibenwischer - Ruitenwisser - Escobillas del limpiaparabrisas -



|  | Fig. | Part N° | OEM | |
|--|------|------------|--------------|-----------|
| C55, C55A, C64, C64A, C70A, CS68, CS75, CS78, CS86, CS94, CS100, CS110, CS120, CS130, CS150, CVX120, CVX130, CVX150, CVX170, CVX1135, CVX1145, CVX1155, CVX1170, CVX1190 (A) CS48, CS52, CS58, CS63 (B) | 1 | 70/1987-40 | 1-34-674-006 | L : 400mm |

(A) Essuie-glace avant - Front wiper blade - Scheibenwischer Front - Ruitenwisser voorruit - Limpiaparabrisa delantero

(B) Essuie-glace avant et arrière - Front and rear wiper blade - Scheibenwischer Front u Heckscheibe - Ruitenwisser voorruit een acterruit - Limpiaparabrisa delantero y trasero





CASE-IH PARTS

**Interrupteur "Warning" - Switch "Warning" - Warnblinklichtschalter "Warning"
- Schakelaar "Warning" - Interruptor "Warning"**



|  | Part N° | OEM |
|---|----------|--------------------------|
| 323, 353, 353E, 383, 423, 423E, 433, 433V, 453, 533, 533E, 533V, 553, 633, 633E, 633V, 654, 724, 733, 733E, 824, 833, 833E | 63/959-1 | 3136609R91 3136609R92 |





CASE IH PARTS

Stabilisateur - Stabiliser - Stabilisator - Stabilisator - Estabilizador

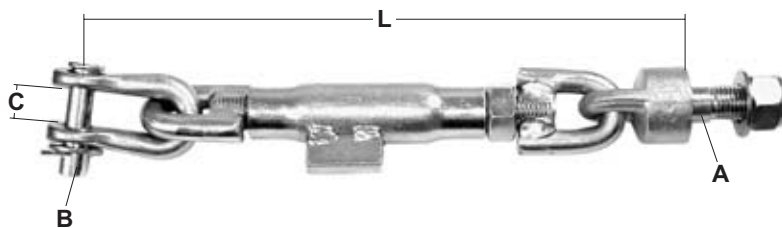

|  | Part N° | OEM | Ø A mm | Ø B mm | C mm | L (min - max) mm |
|---|------------------|----------------------|-----------|-----------|---------|---------------------|
| 2120, 2130, 2140, 2150 PRO PJN55, PJN65, PJN75, PJV55, PJV65, PJV75 | 25/740-54 | 336104A1 404415A1 | 20 | 16 | 18 | 345-415 |





TRACPIECES

**PRODUCT
NEWS-SHEET**

**PAGE : N° 7276
DATE : 08/04**

CASE IH PARTS

Pompe hydraulique (relevage) - Hydraulic pump (hydr. lift) - Hydrauliekpomp (lift) -
Hydraulikpumpe (lift) - Bomba hidráulica (elevador)



|  | Part N° | OEM |
|---|-------------------|-----------|
| 2120, 2130, 2140, 2150 | 69/566-126 | 1967851C1 |

Les références des pièces sont indicatives.
Nos pièces ne sont pas d'origine.

*Part numbers are quoted for reference purposes only.
Our parts and accessories are not original.*



"THE RELIABLE SERVICE"





CASE IH PARTS

Unité de direction - Steering unit - Stuur-unit - Orbitrol - Unidad de dirección



|  | Part N° | OEM |
|---|------------------|--|
| CS100, CS110, CS120, CS130, CS150 CVX120, CVX130, CVX150 CVX1135, CVX1145, CVX1155, CVX1170 | 25/560-35 | 1-32-547-021 1-33-247-015 1-33-147-147 1-33-147-137 1-32-547-001 |





DAVID BROWN PARTS

Radiateur - Radiator - Radiateur - Kühler - Radiador



|  | Fig. | Part N° | OEM |
|---|------|-----------|--|
| 1290, 1294, 1390 | 1 | 20/150-77 | K262827, K300103, K300106, K302915, K302917, K307992 |





TRACPIECES

**PRODUCT
NEWS-SHEET**

**PAGE : N° 7262
DATE : 08/04**

CASE IH PARTS

Plaquettes de frein - Disc brake pads - Remblokkenset - Bremsklötze - Pastillas de freno

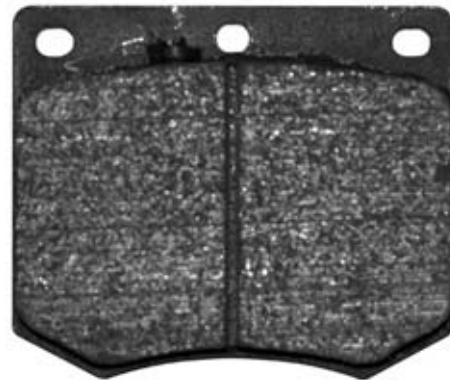
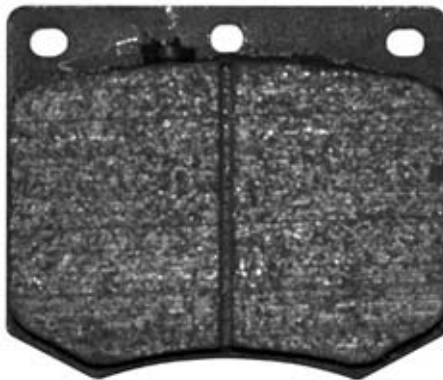

|  | Part N° | OEM |
|---|------------------|-------------------------------------|
| 1255, 1255XL 1455, 1455XL | 25/412-17 | 1964205C1 3401145R1 3401146R1 |

Les références des pièces sont indicatives.
Nos pièces ne sont pas d'origine.

*Part numbers are quoted for reference purposes only.
Our parts and accessories are not original.*





"THE RELIABLE SERVICE"



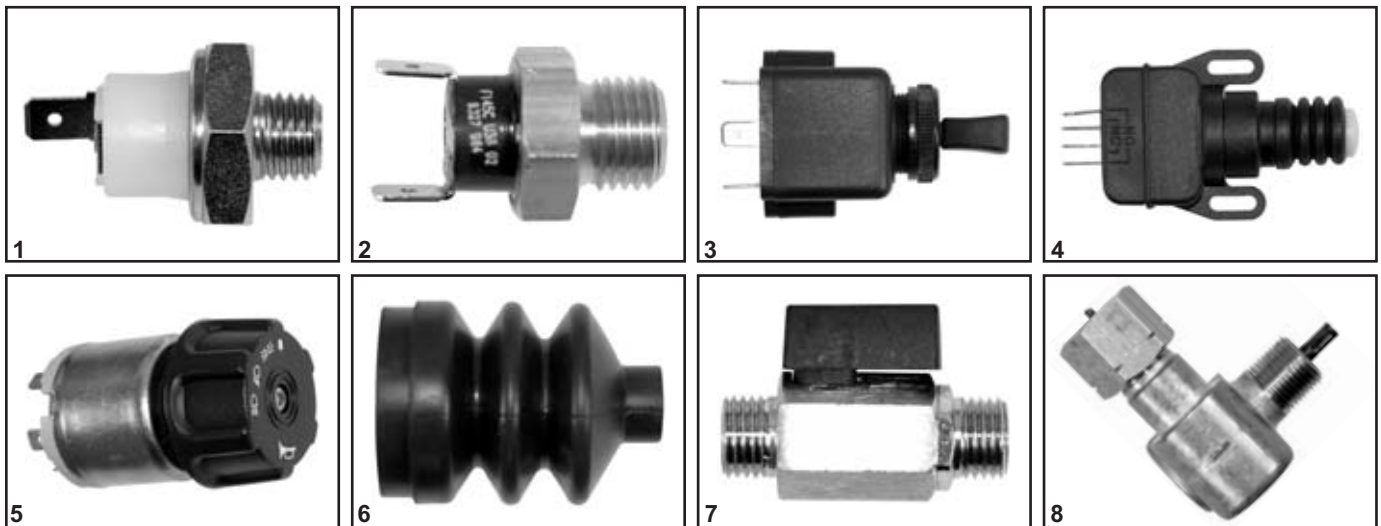

CASE IH PARTS



|  | Fig. | Part N° | OEM | Description - Description - Omschrijving - Beschreibung - Descripción |
|---|------|-----------|-----------------------|--|
| 2120, 2130, 2140, 2150 | 1 | 25/186-20 | 1967900C1 396879A1 | Contact pression d'huile - Oil pressure switch - Oliedrukkzender - Öldruckschalter - Manocontacto presión de aceite |
| 2120, 2130, 2140, 2150, PJ/PJN/PJV 55/65/75 | 2 | 25/174-18 | 325154A1 B506828 | Sonde de température - Temperature sender - Temperatuurzender - Temperatursender - Sensor de temperatura |
| 2120, 2130, 2140, 2150 | 3 | 25/958-49 | 1966927C1 | Commutateur clignotant - Switch (flasher) - R.a.w.-schakelaar - Blinkerschalter - Interruptor luz |
| 2120, 2130, 2140, 2150, PJ/PJN/PJV 55/65/75 | 4 | 25/962-20 | 116256A1 C1941892 | Interrupteur de stop - Stop light switch - Stopschakelaar - Stopplichtschalter - Interruptor de luz de parada |
| 2120, 2130, 2140, 2150 | 5 | 25/967-48 | 1966928C1 | Contacteurs combiné - Combined switch - Gecombineerde schakelaar - Mehrfunktionsschalter - Contactors combinado |
| 2120, 2130, 2140, 2150, PJ/PJN/PJV 55/65/75 | 6 | 25/551-19 | 1967581C1 | Coiffe - Cowl - Stofkap - Flansch - Guardapolvos |
| 2120, 2130, 2140, 2150, PJ/PJN/PJV 55/65/75 | 7 | 25/103-15 | 1967790C1 | Robinet du réservoir - Fuel tap - Tankkraan - Tankhahn - Grifo del depósito |
| 2120, 2130, 2140, 2150 | 8 | 25/58-19 | 1530357C1 | Renvoi d'angle - Tachometer drive unit - Urentelleraandrijving - Antrieb - Reenvío |





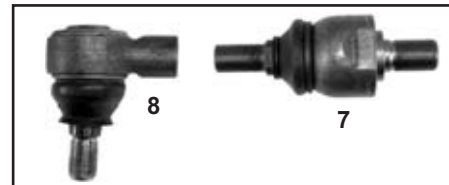
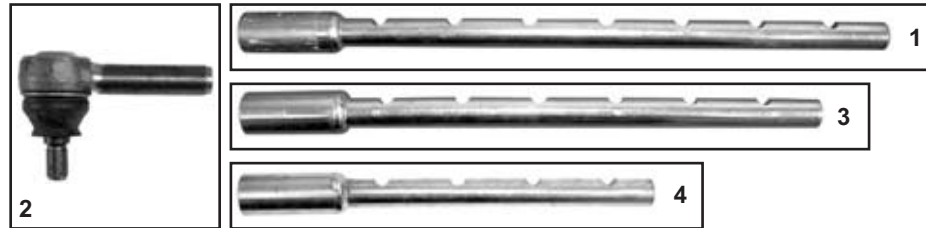

CASE IH PARTS

Rotules & tirants de direction - Steering links & sockets - Stuurkogels en stangen - Kugelgelenke und Spurstangen - Rótulas y acoples de dirección



|  | Fig. | Part N° | OEM | Pos. |  | mm |  |
|--|------|------------|-------------------------|-------|---|-----|---|
| 2120, 2130, 2140 PRO, PJ55, PJ65 2 WD | 1 | 25/497-189 | 1967936C1 | RH | F 20x1.5 LH | 435 | - |
| | | 25/497-190 | 1967937C1 | LH | F 20x1.5 RH | 435 | - |
| | 2 | 25/495-186 | K261841, 1966151C1 | RH | M 20x1.5 LH | 95 | 16.5/18.5 |
| | | 25/495-187 | K261842, 1966150C1 | LH | M 20x1.5 RH | 95 | 16.5/18.5 |
| 2120, 2130, 2140, 2150, PJN55, PJN65 2 WD NARROW | 3 | 25/497-187 | 1967974C1, 327846A1 | RH | F 20x1.5 LH | 386 | - |
| | | 25/497-188 | 1967976C1, 327847A1 | LH | F 20x1.5 RH | 386 | - |
| | 2 | 25/495-186 | K261841, 1966151C1 | RH | M 20x1.5 LH | 95 | 16.5/18.5 |
| | | 25/495-187 | K261842, 1966150C1 | LH | M 20x1.5 RH | 95 | 16.5/18.5 |
| 2120, 2130, 2140, 2150, PJV55, PJV65 2 WD VINEYARD | 4 | 25/497-182 | 327845A1, 1967500C1 | RH | F 20x1.5 LH | 272 | - |
| | | 25/497-183 | 327826A1, 1967975C1 | LH | F 20x1.5 RH | 272 | - |
| | 2 | 25/495-186 | K261841, 1966151C1 | RH | M 20x1.5 LH | 95 | 16.5/18.5 |
| | | 25/495-187 | K261842, 1966150C1 | LH | M 20x1.5 RH | 95 | 16.5/18.5 |
| PJ75 4 WD | 2 | 25/495-186 | K261841, 1966151C1 | RH | M 20x1.5 LH | 95 | 16.5/18.5 |
| | | 25/495-187 | K261842, 1966150C1 | LH | M 20x1.5 RH | 95 | 16.5/18.5 |
| 2120, 2130, 2140, 2150, 4 WD NARROW | 5 | 25/497-151 | 1966127C1, 1-33-741-675 | RH | 20x1.5 RH - 18x1.5 LH | 177 | - |
| | | 25/497-150 | 1966125C1 | LH | 20x1.5 RH - 18x1.5 RH | 177 | - |
| | 6 | 25/495-188 | 1966128C1, 135823A1 | RH | F 18x1.5 LH | 85 | 20/22.5 |
| | | 25/495-189 | 1966129C1, 135824A1 | LH | F 18x1.5 RH | 85 | 20/22.5 |
| 238, 248, 258, 268, 288, 395, 495, 495XL, 595, 595XL, 695, 695XL, 795, 795XL, 895, 995, 995XL, 3210, 3220, 3230, 4210, 4220, 4230, 4240, C50, C60, C70, C80, C90, C100, MX80C, MX90C, MX100C 4 WD | 5 | 25/497-151 | 1966127C1, 1-33-741-675 | RH | 20x1.5 RH - 18x1.5 LH | 177 | - |
| | | 25/497-150 | 1966125C1 | LH | 20x1.5 RH - 18x1.5 RH | 177 | - |
| 2120, 2130, 2140, 2150, PJV 55/65/75 4 WD VINEYARD | 7 | 25/497-184 | 112514A1 | RH/LH | 20x1.5 RH - 18x1.5 RH | 137 | - |
| | 8 | 25/495-190 | 138523A1 | RH/LH | F 18x1.5 RH | 53 | 20/22.5 |

Les références des pièces sont indicatives.
Nos pièces ne sont pas d'origine.



Part numbers are quoted for reference purposes only.
Our parts and accessories are not original.

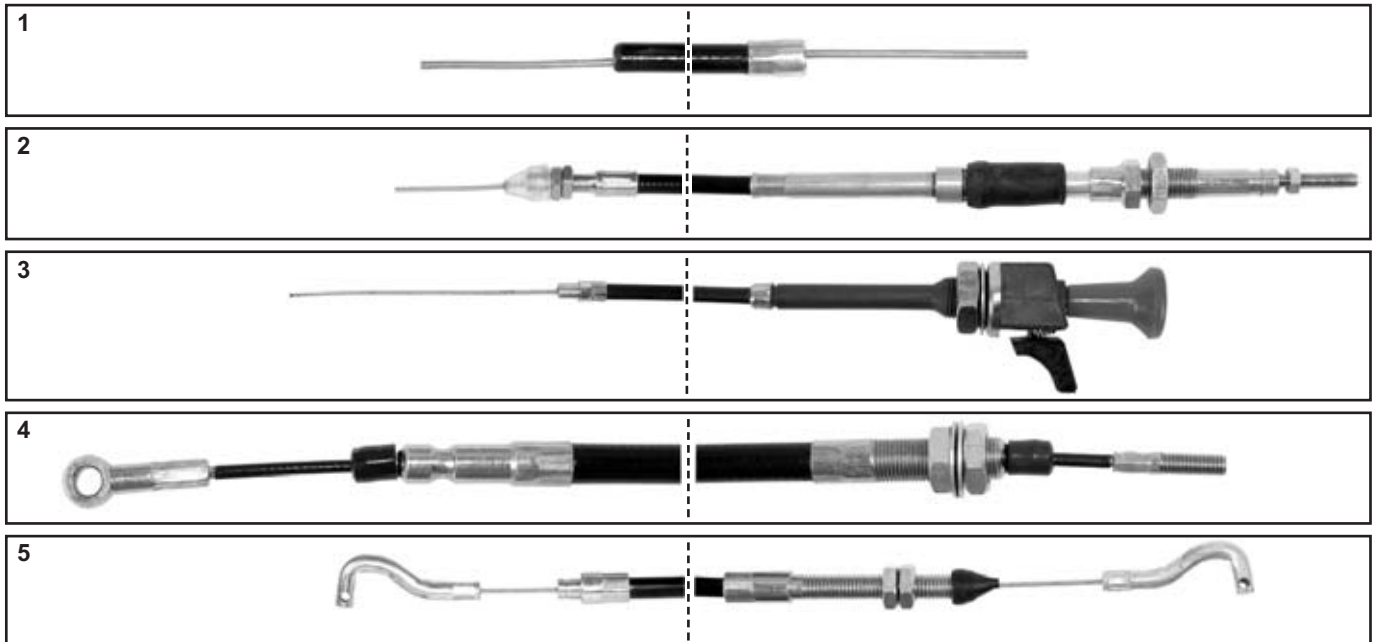

CASE IH PARTS

Câbles de commandes - Operating cables - Bedieningskabels - Bedienungskabels
Betriebskabel - Cables de mando



|  | Fig. | Part N° | OEM | L mm | Description - Description - Omschrijving - Beschreibung - Descripción |
|--|------|-----------|-------------------------------------|---------|--|
| Câble d'arrêt - Stop cable - Stopkabel - Stopzüge - Cable parada | | | | | |
| 248, 268, 278, 385, 485, 585, 684, 685, 784, 785 | 1 | 25/107-16 | 3125551R1 3129725R1 | 1250 | |
| 268, 278, 454, 474, 574, 584, 585, 674, 684, 685, 784, 785, 884, 885 | 1 | 25/107-17 | 529001R1 | 1000 | Pompes - Pumps - Pompen - Pumpen - Bombas Bosch |
| 248, 258, 268, 278, 385, 484, 485, 485XL, 584, 585, 585XL, 684, 685, 685XL, 743XL, 745XL, 784, 785, 785XL, 844XL, 884, 885, 885XL | 2 | 25/107-18 | 3234947R2 3129712R1 3129713R1 | 1275 | Pompes - Pumps - Pompen - Pumpen - Bombas VA |
| 248, 454, 484, 485 | 1 | 25/107-19 | 3112806R1 | 900 | Pompes - Pumps - Pompen - Pumpen - Bombas CAV |
| 268, 278, 585, 684, 685, 784, 785, 884, 885 | 2 | 25/107-20 | 3129724R1 | 1630 |  SEKURA |
| 2120/2130/2140/2150 PRO, PJ/PJN/PJV 55/65/75 | 3 | 25/107-21 | 324406A1 1547442C1 | 600 | |
| Câble de frein à main - Hand brake cable - Handrem kabel - Handbremszug - Cable freno de mano | | | | | |
| 3210, 3220, 3230, 4210, 4220, 4230, 4240 | 4 | 25/409-29 | 134779A1 118777A2 | 860 | |
| Câble d'accélérateur - Accelerator cable - Handgaskabel - Gaszug - Cable acelerador | | | | | |
| 485XL, 495XL, 585, 585XL, 595, 595XL, 685, 685XL, 695, 695XL, 785XL, 795XL, 885, 885XL, 895, 895XL, 995, 995XL, 3210, 3220, 3230, 4210, 4220, 4230, 4240 | 5 | 25/108-30 | 3401585R3 | 1450 | |
| 743XL, 745XL, 844XL, 845XL, 856XL | 5 | 25/108-31 | 3234948R3 | 1590 | |



CASE IH - 4WD - CARRARO / SIGE

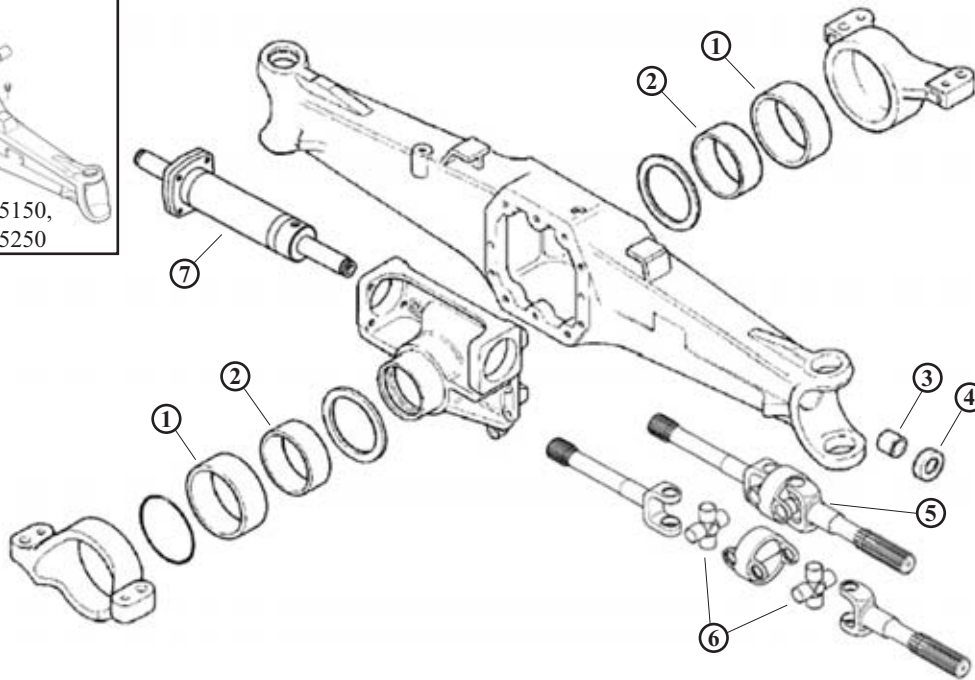
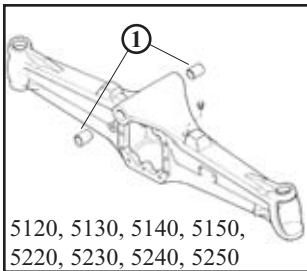

|  | 1 | 2 | 3 | 4 | 5 | 6 | 7 | |
|---|----------------------|----------------------|-------------------------|--|-------------------------|------------------------------------|-----------------------------------|--|
| 238, 248, 258, 268, 288 | 25/486-59 K965266 | 25/486-60 K965265 | 25/6462-35 1966186C1 | 25 /6407-39 1966191C1 | 25/6402-30 1537637C1 | 25/6403-61 100546A1 | 25/580-10 1537617C1 | |
| 395, 495, 495XL, 595, 595XL, 695, 695XL, 795, 795XL, 895, 995, 995XL | | | | | | | | |
| 1290, 1390, 1490, 1690 | | | | | | | | |
| 1294, 1394, 1494, 1594, 1694 | | | | | | 25/6407-47 N8897 Except 1294 | | |
| 2120, 2130, 2140, 2150 | | | 25/6462-35 1966186C1 | 25/6407-39 1966191C1 25/6407-47 N8897 | | 25/6403-61 100546A1 | | |
| 3210, 3220, 3230 | 25/486-59 K965266 | 25/486-60 K965265 | | 25/6407-39 1966191C1 | 25/6402-30 1537637C1 | | 25/580-10 1537617C1 | |
| 4210, 4220, 4230, 4240 | | | | | | | | |
| 5120, 5130, 5140, 5150 | 25/486-64 81852C1 | | 25/6462-39 D142950 | 25/6407-47 N8897 | 25/6402-31 81882C1 | 25/6403-62 N14411 144465A1 | 25/580-11 1530744C1 81870C1 | |
| 5220, 5230, 5240, 5250 | | | | | | | | |
| C50, C60 | 25/486-59 K965266 | 25/486-60 K965265 | 25/6462-35 1966186C1 | 25/6407-40 311565A1 25/6407-39 1966191C1 | 25/6402-30 1537637C1 | 25/6403-61 100546A1 | 25/580-10 1537617C1 | |
| C70, C80, C90, C100 | | | | | | | | |

Les références des pièces sont indicatives.
Nos pièces ne sont pas d'origine.

Part numbers are quoted for reference purposes only.
Our parts and accessories are not original.



"THE RELIABLE SERVICE"



CASE IH - 4WD - CARRARO / SIGE

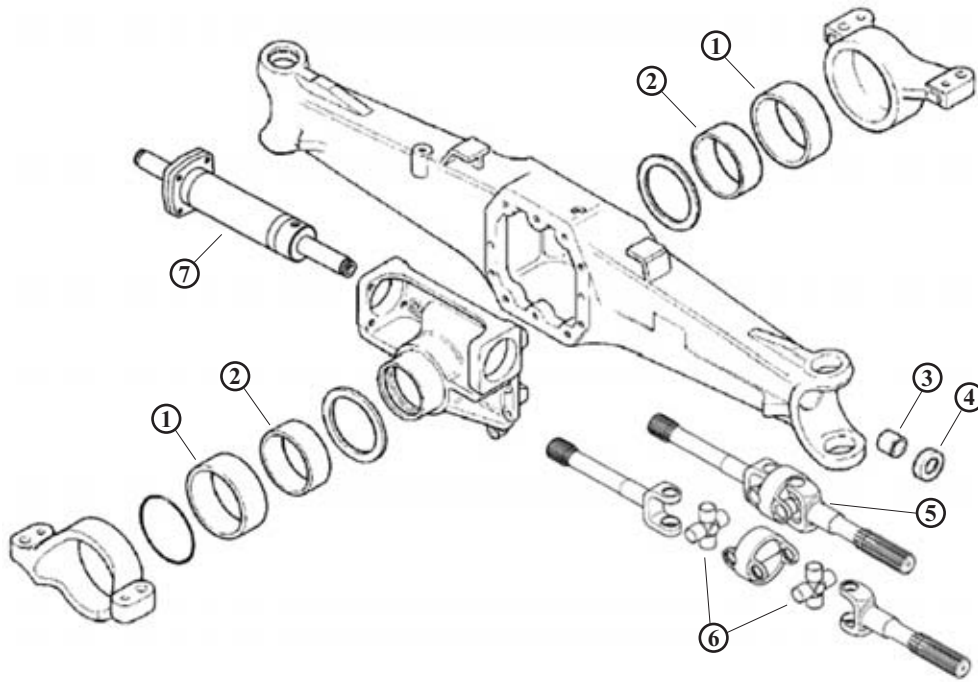





|  | 1 | 2 | 3 | 4 | 5 | 6 | 7 | | |
|---|----------------------|----------------------|--|---|-------------------------|----------------------------------|-------------------------|----------------------------------|------------------------|
| CS100, CS110, CS120, CS130, CS150 | 25/486-59 K965266 | 25/486-60 K965265 | 25/6462-39 D142950 | 25/6407-47 N8897 | | 25/6403-62 N14411 144465A1 | | | |
| CS48, CS52, CS58, CS63, CS68, CS75 | | | | | | | | | |
| CS78, CS86, CS94 | | | | | 25/6462-35 1966186C1 | 25/6407-39 1966191C1 | | 25/6403-62 N14411 144465A1 | |
| CVX1135, CVX1145, CVX1155, CVX1170, CVX1190 | | | | | 25/6462-39 D142950 | | | | |
| CVX120, CVX130, CVX150, CVX170 | | | | | | | | | |
| CX50, CX60, CX70, CX80, CX90, CX100 | | | | | 25/6462-35 1966186C1 | 25/6407-39 1966191C1 | 25/6402-30 1537637C1 | 25/6403-61 100546A1 | 25/580-10 1537617C1 |
| M968, M975 | | | | 25/6407-40 311565A1 | | | | | |
| MX100, MX110, MX120, MX135, MX150, MX170 | | | 25/6462-39 D142950 | 25/6407-48 247519A1 | | | | | |
| MX80C, MX90C, MX100C | 25/486-59 K965266 | 25/486-60 K965265 | 25/6462-35 1966186C1 25/6462-39 D142950 | 25/6407-39 1966191C1 25/6407-40 311565A1 25/6407-48 247519A1 | 25/6402-30 1537637C1 | 25/6403-61 100546A1 | 25/580-10 1537617C1 | | |
| PJ55, PJ65, PJ75, PJN55, PJN65, PJN75, PJV55, PJV65, PJV75 | | | 25/6462-35 1966186C1 | 25/6407-40 311565A1 | | | | | |

Les références des pièces sont indicatives.
Nos pièces ne sont pas d'origine.

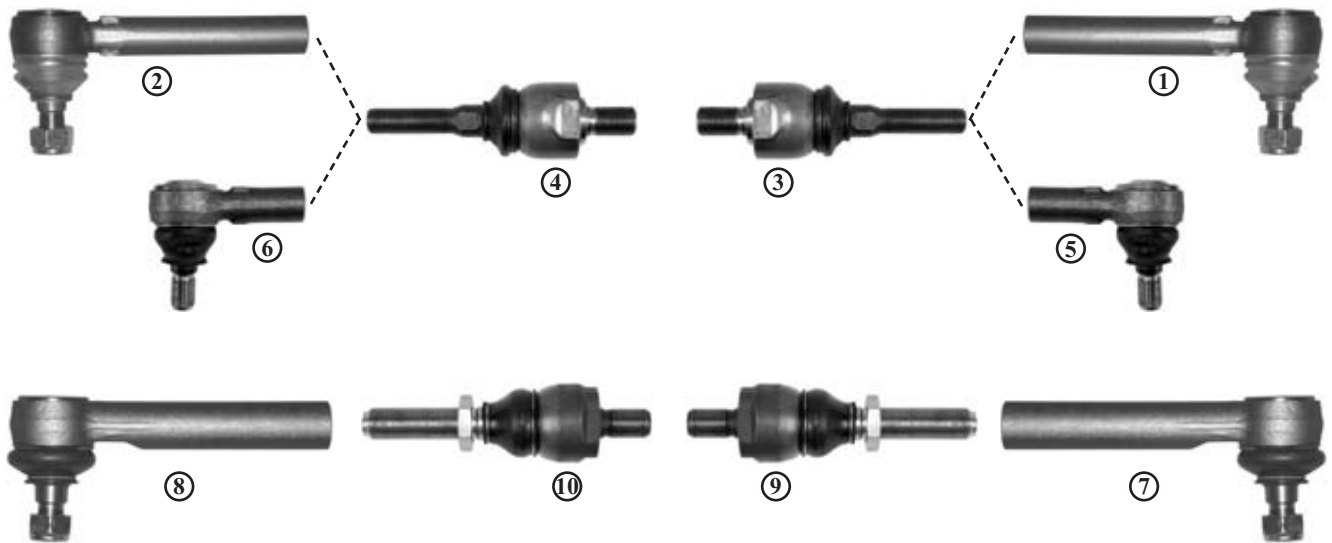
Part numbers are quoted for reference purposes only.
Our parts and accessories are not original.

CASE IH - 4WD - CARRARO / SIGE



|  | Fig. | Part N° | OEM | Pos. |  |  mm |  |
|--|------|-------------------|---------------------|-------|---|--|---|
| 238, 248, 258, 268, 288, 395, 495, 495XL, 595, 595XL, 695, 695XL, 795, 795XL, 895, 995, 995XL, 3210, 3220, 3230, 4210, 4220, 4230, 4240, C50, C60, C70, C80, C90, MX80C, MX90C, MX100C | 1 | 25/495-241 | 137048A1, 1537612C1 | RH | F 18 x 1.5 RH | 172 | 20/22 |
| | 2 | 25/495-242 | 137047A1, 1537611C1 | LH | F 18 x 1.5 LH | 172 | 20/22 |
| | 3 | 25/497-150 | 1966125C1 | RH | 20 x 1.5 RH / 18 x 1.5 RH | 177 | - |
| | 4 | 25/497-151 | 1966127C1 | LH | 20 x 1.5 RH / 18 x 1.5 LH | 177 | - |
| 2120, 2130, 2140, 2150 Narrow 4WD | 5 | 25/495-188 | 1966128C1, 135823A1 | RH | F 18x1.5 LH | 85 | 20/22 |
| | 6 | 25/495-189 | 1966129C1, 135824A1 | LH | F 18x1.5 RH | 85 | 20/22 |
| | 3 | 25/497-150 | 1966125C1 | RH | 20 x 1.5 RH / 18 x 1.5 RH | 177 | - |
| | 4 | 25/497-151 | 1966127C1 | LH | 20 x 1.5 RH / 18 x 1.5 LH | 177 | - |
| 5120, 5130, 5140, 5150, 5220, 5230, 5240, 5250 | 7 | 25/495-68 | 126145A1 | LH | F 24 x 1.5 RH | 204 | 23/26 |
| | 8 | 25/495-67 | 126144A1 | RH | F 24 x 1.5 LH | 204 | 23/26 |
| | 9 | 25/497-17 | 247522A1, N14377 | LH | 22 x 1.5 RH / 24 x 1.5 RH | 205 | - |
| | 10 | 25/497-44 | N14388 | RH | 22 x 1.5 RH / 24 x 1.5 LH | 205 | - |
| CX50, CX60, CX70, CX80, CX90, CX100 | 1-2 | 25/495-241 | 137048A1 | LH/RH | F 18 x 1.5 RH | 172 | 20/22 |
| | 3-4 | 25/497-150 | 1966125C1 | LH/RH | 20 x 1.5 RH / 18 x 1.5 RH | 177 | - |
| MX80C, MX90C, MX100C, MX100, MX110, MX120, MX135, MX150, MX170 | 9-10 | 25/497-17 | 247522A1, N14377 | LH/RH | 22 x 1.5 RH / 24 x 1.5 RH | 205 | - |
| | 8 | 25/495-245 | 247523A1 | LH/RH | F 24 x 1.5 RH | 265 | 23.5/26 |

CASE IH - 4WD - CARRARO / SIGE

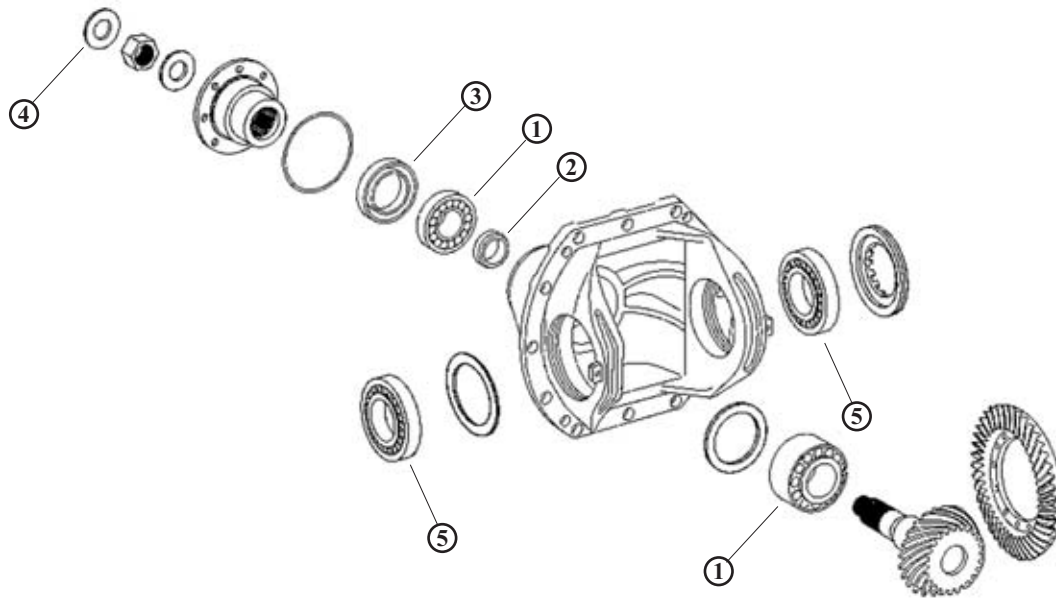

|  | 1 | 2 | 3 | 4 | 5 |
|--|-----------------------|---|-----------------------|----------------------|------------------------|
| 1290, 1390, 1490 | | 25/361-5 1349058C1 Except 1394, CVX170 | | 25/346-11 K261065 | 25/352-8 3140666R91 |
| 1394, 1494, 1594 | 25/353-18 K395090 | | 25/355-13 81873C1 | | |
| 5120, 5130, 5140, 5150, 5220, 5230, 5240, 5250 | | | | | |
| CS100, CS110, CS120, CS130, CS150 | | | | | |
| CVX120, CVX130, CVX150, CVX170, CVX1135, CVX1145, CVX1155 | | | | | |
| CVX1170, CVX1190 | 25/353-19 X1139855 | | | | |
| MX80C, MX90C, MX100C | 25/353-18 K395090 | | | | |
| MX100, MX110, MX120, MX135, MX150, MX170 | 25/353-19 X1139855 | | 25/355-14 247534A1 | | |

CASE IH - 4WD - CARRARO / SIGE

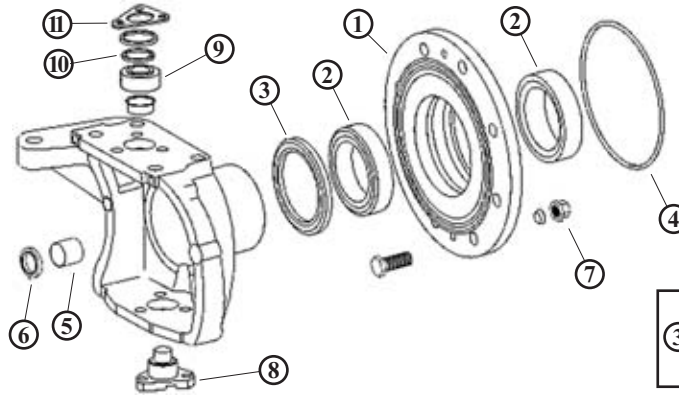

25/6408-49 ⇒ 130 x 160 x 17
 ③ 25/6408-29 ⇒ 150 x 176 x 16
 25/6408-51 ⇒ 155 x 176 x 16

|  | 1 | 2 | 3 | 4 | 5 | | |
|---|---------------------|----------------------------------|-------------------------------------|-----------------------|-------------------------------------|-------------------------|-------------------------|
| 238, 248, 258, 268, 288 | 25/445-8 K395123 | 25/6410-8 1966169C1 | 25/6408-49 1984938C1 311569A1 | 25/6413-6 100552A1 | 25/6462-37 100532A1 | | |
| 395, 495, 495XL, 595, 595XL, 695, 695XL, 795, 795XL, 895, 995, 995XL | | | 25/6408-29 247877A1 K395102 | | | | |
| 1294, 1394, 1494, 1594 | | | 25/6408-51 1349265C1 | | | | |
| 1896, 2096 | | | | | | | |
| 2120, 2130, 2140, 2150 | 25/445-8 K395123 | 25/6410-8 1966169C1 | 25/6408-49 1984938C1 311569A1 | 25/6413-6 100552A1 | 25/6462-37 100532A1 | | |
| 3210, 3220, 3230 | | | 25/6408-29 247877A1 K395102 | | 25/6462-38 1967535C1 | | |
| 4210, 4220, 4230, 4240 | | | 25/6408-49 1984938C1 311569A1 | | 25/6462-37 100532A1 | | |
| 5120, 5130, 5140, 5150 | | | 25/6410-32 81676C1 K395101 | | 25/6408-29 247877A1 K395102 | 25/6462-38 1967535C1 | |
| 5220, 5230, 5240, 5250 | | | | | | | |
| C50, C60, C70, C80, C90 | | | 25/6410-8 1966169C1 | | 25/6408-49 1984938C1 311569A1 | 25/6413-6 100552A1 | 25/6462-37 100532A1 |
| CS100, CS110, CS120, CS130, CS150 | | | | | 25/6410-32 81676C1 K395101 | | 25/6462-38 1967535C1 |
| CS48, CS58 | | | | | | | |
| CS68, CS75 DBD0040001 ⇒ | | | 25/6408-49 1984938C1 311569A1 | 25/6413-6 100552A1 | 25/6462-37 100532A1 | | |
| CS78, CS86, CS94 DBD0055001 ⇒ | 25/445-8 K395123 | 25/6410-8 1966169C1 | | | | | |
| CVX120, CVX130, CVX150, CVX170, CVX1135, CVX1145, CVX1155, CVX1170, CVX1190 | | 25/6410-32 81676C1 K395101 | | | | | |
| CX50, CX60, CX70, CX80, Cx90, CX100 | 25/445-8 K395123 | 25/6410-8 1966169C1 | 25/6408-49 1984938C1 311569A1 | 25/6413-6 100552A1 | | | |
| MX100, MX110, MX120, MX135 | | 25/6410-32 81676C1 K395101 | | | 25/6462-37 100532A1 | | |
| MX150, MX170 | | | | | | | |
| MX80C, MX90C, MX100C | | | | | 25/6462-37 100532A1 | | |
| PJ55, PJ65, PJ75 | | | 25/6408-49 1984938C1 311569A1 | 25/6413-6 100552A1 | 25/6462-37 100532A1 | | |
| PJN55, PJN65, PJN75, PJV55, PJV65, PJV75 | | | | | 25/6462-38 1967535C1 | | |

CASE IH - 4WD - CARRARO / SIGE

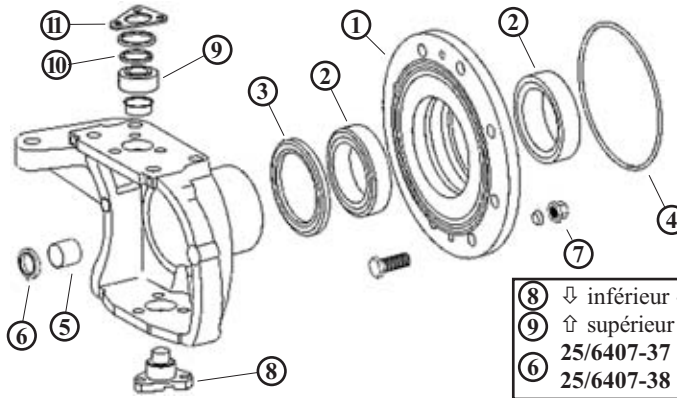



- 25/6453-28 ⇒ 0.10 mm
- 25/6453-29 ⇒ 0.19 mm
- 25/6453-30 ⇒ 0.35 mm
- II
- 8 ↓ inférieur - lower - Onder - Unter - Inferior
- 9 ↑ supérieur - upper - Boven - Oben - Superior
- 25/6407-37 ⇒ 45 x 65 x 12
- 25/6407-38 ⇒ 35 x 52 x 16

|  | 6 | 7 | 8 | 9 | 10 | 11 |
|---|-----------------------------------|-----------------------|---|---|---|--|
| 238, 248, 258, 268, 288 | 25/6407-37 100529A1 | 25/441-23 905667R1 | | 25/6451-34↑ 100522A1 | 25/6425-42 1966038C1 | |
| 395, 495, 495XL, 595, 595XL, 695, 695XL, 795, 795XL, 895, 995, 995XL | | | 25/6451-35↓ 100520A1 | | | |
| 644, 685, 743, 743XL, 744, 745S, 745XL, 785, 844, 844S, 844XL, 845, 845XL, 856XL, 885, 956, 956XL, 1056, 1056XL | | | | | | |
| 1294, 1394, 1494, 1594 | 25/6407-38 295151A1 K262143 | | | | 2 x 25/6425-43 K395039 Except 1294 | 25/6453-28 K395036 25/6453-29 K395037 25/6453-30 K395038 Except 1294 |
| 2120, 2130, 2140, 2150 | 25/6407-37 100529A1 | 25/441-23 905667R1 | | 25/6451-34↑ 100522A1 | 25/6425-42 1966038C1 | |
| 3210, 3220, 3230 | | | 25/6451-35↓ 100520A1 | | | |
| 4210, 4220, 4230, 4240 | | | | | | |
| 5120, 5130, 5140, 5150, 5220, 5230, 5240, 5250 | 25/6407-38 295151A1 K262143 | | 25/6450-19↓ N13504 25/6450-18↑ 1995414C1 | 25/6451-26↓ K395040 N14373 25/6451-36↑ N14372 | 2 x 25/6425-43 K395039 | 25/6453-28 K395036 25/6453-29 K395037 25/6453-30 K395038 |
| C50, C60, C70, C80, C90 | | 25/441-23 905667R1 | | 25/6451-34↑ 100522A1 25/6451-35↓ 100520A1 | | |
| CS48, CS58, CS78, CS86, CS94 | 25/6407-37 100529A1 | | | | | |
| CS52, CS63 DBD0030401 ⇒ | | | | | | |
| CS68, CS75 DBD0040001 ⇒ | | | | | | |
| CS100, CS110, CS120, CS130, CS150 | 25/6407-38 295151A1 K262143 | | 25/6450-**↑ 122260A1 Except CVX | 25/6451-26↓ K395040 N14373 25/6451-36↑ N14372 | | |
| CVX120, CVX130, CVX150 | | | 25/6450-33↓ 122259A1 | 25/6451-36↑ N14372 | | |
| CVX1135, CVX1145, CVX1155, CVX1170, CVX1190 | | | | | | |
| CX50, CX60, CX70, CX80, CX90, CX100 | 25/6407-37 100529A1 | 25/441-23 905667R1 | | 25/6451-34↑ 100522A1 | 25/6425-27 247503A1 | |
| MX80C, MX90C, MX100C | | | 25/6451-35↓ 100520A1 | | | |
| MX100, MX110, MX120, MX135, MX150, MX170 | | | 25/6450-**↑ 122260A1 Except MXC ou 25/6450-32↑ 247517A1 25/6450-33↓ 122259A1 | 25/6451-26↓ K395040 N14373 25/6451-36↑ N14372 | | |
| PJ55, PJ65, PJ75, PJN55, PJN65, PJN75, PJV55, PJV65, PJV75 | | | | 25/6451-34↑ 100522A1 25/6451-35↓ 100520A1 | | |

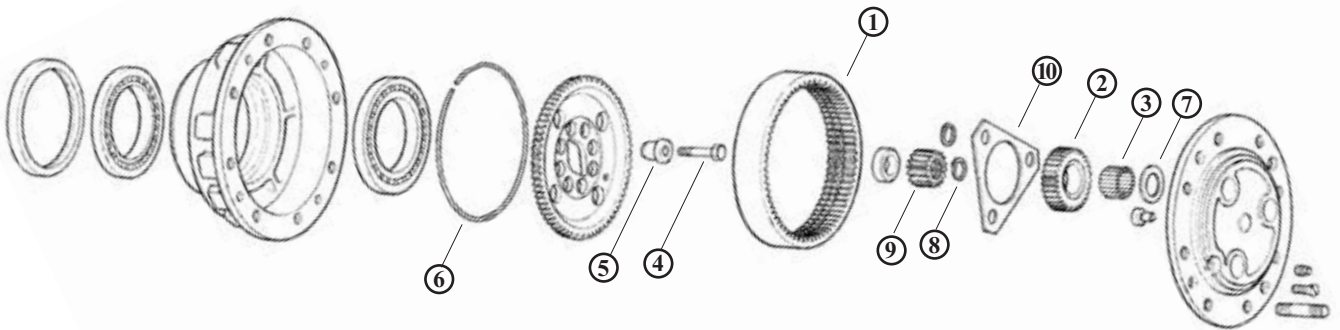
CASE IH - 4WD - CARRARO / SIGE







|  | 1 | 2 | 3 | 4 | 5 | |
|---|---|---|---|---|---|--|
| 1394, 1494, 1594 | 25/6430-18 H437677 Except 1394 | 25/6431-16 N13513 | 25/6433-11 119686A1 N13514 | 25/452-17 K395131 | 25/451-12 107071A1 | |
| 5120, 5130, 5140, 5150, 5220, 5230, 5240, 5250 | | | | | | |
| CS100, CS110, CS120, CS130, CS150 | | | | | | |
| CVX120, CVX130, CVX150, CVX170, CVX1135, CVX1145, CVX1155, CVX1170, CVX1190 | | | | | | |
| MX100, MX110, MX120, MX135, MX150, MX170 | | | | | | |
|  | 6 | 7 | 8 | 9 | 10 | |
| 1294, 1394, 1494, 1594 | 25/6436-3 H437679 Exept 1294, 1394 | 25/384-8 K395091 Except 1294 | 25/6434-19 K261897 | 25/6406-20 K395114 Except 1294 | 25/6401-15 K395122 Except 1294 | |
| 5120, 5220 | | | | | 25/6401-15 K395122 | |
| 5130, 5140, 5150, 5230, 5240, 5250 | | | | | | |
| CS100, CS110, CS120 | | | | | | |
| CS130, CS150 | | | | | | |
| 2120, 2130, 2140, 2150 | | | | | | |
| 238, 248, 258, 268, 288 | | | | | | |
| 3210, 3220, 3230 | | | | | | |
| 4210, 4220, 4230, 4240 | | | | | | |
| C50, C60, C70, C80, C90 | | | | | | |
| CS48, CS52, CS58, CS63, CS68, CS75, CS78, CS86, CS94 | | | | | | |
| CX50, CX60, CX70, CX80, CX90, CX100 | | | | | | |
| PJ55, PJ65, PJ75 | | | | | | |

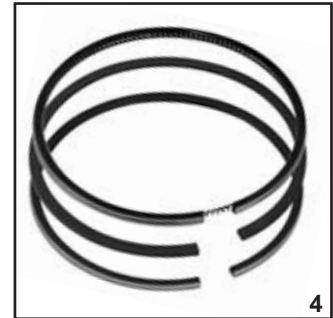
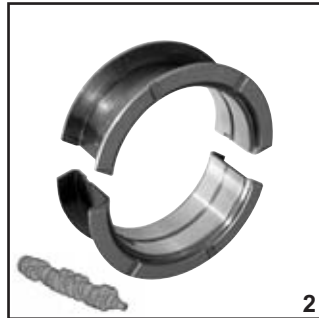
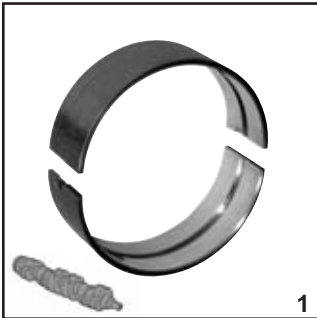

CASE IH PARTS

Moteurs Cummins - Cummins engines - Cummins motortype - Cummins Motore - Motores Cummins





|  |  |  | 1 | 2 | 3 | 4 |
|--|--|--|---------------------|--------------------------------|----------------------------------|----------------------------------|
| 5120, 5220 | 4T-390 | 4 | 25/7-13 (A77405) | 25/8-13 (A77406, A77896) | 25/9-13 (A77465, K3543274) | 25/34-91 (A77727, J802746) |
| 5130, 5140, 5230, 5240, 5250 | 6-590 | 6 | | | | 25/34-92 (A77401) |
| 5130, 5140, 5150, 5230, 5240, 5250 | 6T-590 | 6 | | | | 25/34-91 (A77727, J802746) |
| MX100, MX110, MX120, MX135, MX150, MX170 | | 6 | | | | |

- Les coussinets de palier et de bielles sont disponibles en cote réparation 0,25mm - 0,50mm - 0,75mm. Ajouter respectivement les suffixes A, B ou C.
- Main bearing and conrod bearing sets are available in 0,25mm - 0,50mm - 0,75mm undersize. Please add the suffix A, B or C respectively.
- De hoofdlagers en de drijfstanglagers zijn beschikbaar in overmaat 0,25mm - 0,50mm - 0,75mm Voeg dan bij aan het bestelnr.: A, B of C.
- Alle Haupt- und Pleuellager sind auch in den Übermassen 0,25mm - 0,50mm - 0,75mm. Lieferbar. Bitte ergänzen Sie die Bestell-Nr. mit A, B oder C.
- Cojinetes de bancada y de biela disponibles en las siguientes sobremedidas 0,25mm - 0,50mm - 0,75mm. Adjuntar los prefijos A, B o C. respectivamente.

Moteurs Perkins - Perkins engines - Perkins motortype - Perkins Motore - Motores Perkins



|  |  |  | Part N° | OEM |
|---|---|---|-----------|----------|
| C80, C90, C100, CX80, CX90, CX100, MX80C, MX90C, MX100C | 1004.4T | 4 | 25/34-100 | 293181A1 |





CASE IH PARTS

Radiateurs - Radiators - Radiatoren - Kühler - Radiadores



|  | Fig. | Part N° | OEM |
|---|------|-----------|--|
| 248, 258, 268, 385, 484, 485, 485XL, 584, 585, 585XL, 684, 685, 685XL, 784, 785, 785XL, 885, 885XL, 895XL | 1 | 25/150-74 | 84524C93, 3121414R92, 3121413R91 |
| 268, 288, 485XL, 585, 585XL, 595, 685, 685XL, 695, 695XL, 785, 785XL, 795, 795XL, 885, 885XL, 895, 895XL, 995XL | 2 | 25/150-73 | 84673C6, 84673C5, 84673C4, 84673C3 |
| 844XL, 845XL, 856XL | 3 | 25/150-62 | 3399930R1, 3402579R1, 3404962R2 |





CASE IH PARTS

Courroies trapézoïdales - Fan belts - Vnaren - Keilriemen - Correias



|  | Ref. | OEM | Application - Application - Toepassing - Anwendung - Aplicacione |
|---|------------------|-----------------------|--|
| 5120, 5130, 5140, 5150, 5230, 5240, 5250, MX100, MX110, MX120, MX135, MX150, MX170 | 71/144-68 | 84766C1 | Compresseur - Compressor - Kompressor - Kompressor - Compresor |
| 5120, 5130, 5140, 5150, 5220, 5230, 5240, 5250, MX100, MX110, MX120, MX135 | 71/144-69 | A184652 1341010744 | |







CASE IH PARTS

Amortisseurs - Shock absorbers - Onderleggers - Gummidampfern - Amortiguadores



|  | Fig. | Ref. | OEM |
|--|------|------------|-------------------------|
|  XL | 1 | 25/4114-15 | 3399959R1 |
| | 2 | 25/4114-16 | 3399961R1 |
| 238, 248, 258, 268, 278, 288, 385, 395, 433, 440, 484, 485, 485XL, 495, 495XL, 533, 540, 584, 585, 585XL, 595, 595XL, 633, 640, 684, 685, 685XL, 695, 695XL, 733, 740, 784, 785, 785XL, 795, 795XL, 833, 840, 884, 885, 885XL, 895, 933, 940, 995, 995XL, 3210, 3220, 3230, 4210, 4230, 4240, 5120, 5130, 5140, 5150, 5220, 5230, 5240, 5250 | 3 | 25/4114-17 | 1533773C1 1502231C91 |





CASE IH PARTS

Stabilisateur - Stabiliser - Stabilisator - Stabilisator - Estabilizador

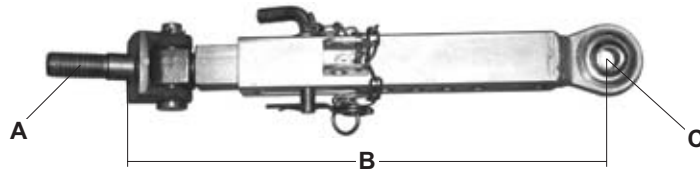

|  | Part N° | OEM | A | B | C |
|--|-----------|----------|---------|------------|---------------------|
| MX80C, MX90C, MX100C, MX100, MX110, MX120, MX135, 5120, 5130, 5140, 5150, 5220, 5240 | 25/740-52 | 112923A1 | M24 x 3 | 440-670 mm | Cat. 1 Ø 19.5 mm |

Rotule à souder - Weld-on lower link arm end - Anschweisskugel - Aanlaskogel - Rótula para soldar

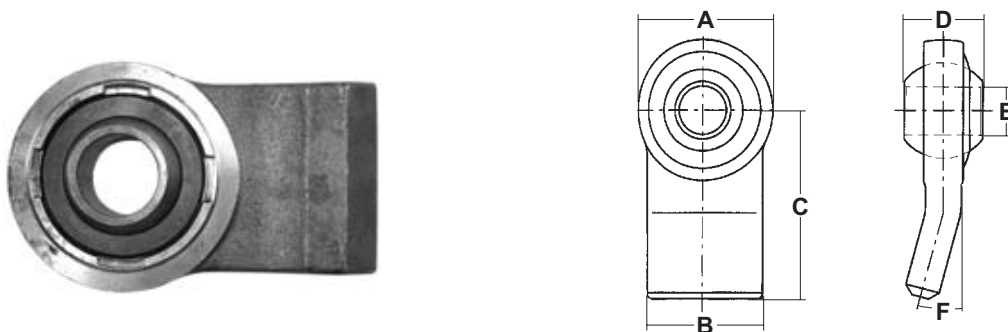

|  | Part N° | A | B | C | D | E | F |
|---|-----------|--------|-------|--------|-------|---------|-----|
| Maxxum Magnum | 25/715-12 | 110 mm | 90 mm | 120 mm | 45 mm | 37.5 mm | 10° |





CASE IH PARTS

Filtration - Filters - Filters - Filter - Filtros





|  | Part N° | OEM | Fig. | |
|---|-------------------|------------------------------|--|--|
| CS48, CS52, CS63, CS68, CS75, CS78, CS86, CS94, M968, M975 | 60/240-100 | 133700730095 133700860001 |  | Filtre hydraulique - Hydraulic filter - Hydrauliekfilter - Hydraulik-Filter - Filtro hidráulico  M33 x 1.5 Ht. : 110 mm |
| CS68, CS75, M968, M975 | 60/240-101 | 132000070726 132000070700 |  | Filtre à huile - Oil filter - Oliefilter - Ölfilter - Filtro de aceite  M24 x 1.5 Ht. : 142 mm |
| CS100, CS110, CS120, CS130, CS150 | 60/641-12 | 1-32-575-303 |  | Filtre hydraulique - Hydraulic filter - Hydrauliekfilter - Hydraulik-Filter - Filtro hidráulico Ø 38 mm |
| CS100, CS110, CS120, CS130, CS150, CVX120, CVX130, CVX150, CVX170, CVX1135, CVX1145, CVX1155, CVX1170, CVX1190, | 60/641-19 | 1-32-575-302 |  | Filtre hydraulique - Hydraulic filter - Hydrauliekfilter - Hydraulik-Filter - Filtro hidráulico  1 ^{3/8} - 12 UNF Ht. : 240 mm |
| CS78, CS86, CS94, CS100, CS110, CS120, CS130, CS150 | 60/641-28 | 1-32-573-072 |  | LOAD SENSING Filtre hydraulique - Hydraulic filter - Hydrauliekfilter - Hydraulik-Filter - Filtro hidráulico  1 ^{1/2} - 16 UNF Ht. : 240 mm |



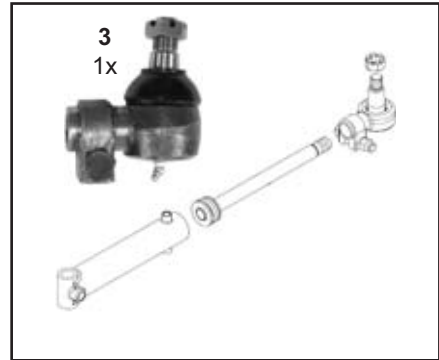
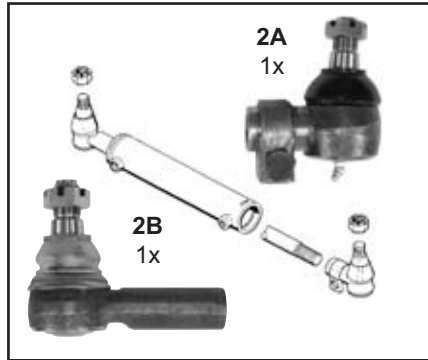
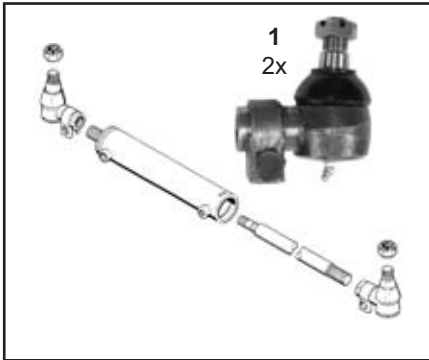

CASE IH PARTS

Pièces d'avant-train - Front axle parts - Vörasdelen - Vörderachsteile -
Piezas para el eje delantero

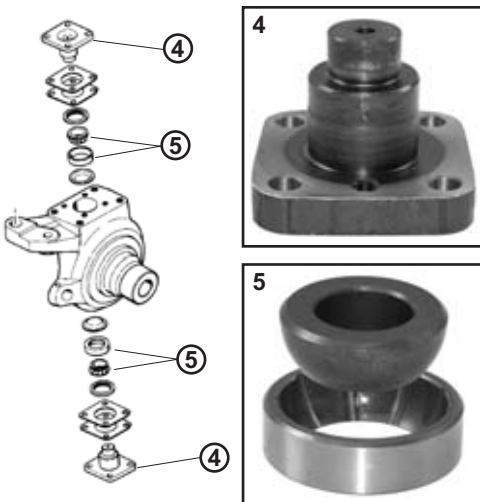

|  | Fig. | Part N° | OEM |  |  |  |
|---|------|-----------|-----------------------|---|---|---|
| 5088, 5288, 5488, | 1 | 25/581-40 | 293624A1 1277261C1 | 25 x 28 mm | 1" x 16 | 75 mm |
| 7110, 7120, 7130, 7140, 7150 | | | | | | |
| | | 2B | 25/581-41 | | - | à souder - to weld - Aanlaskogel - Anschweisskugel - para soldar |
| 7210, 7220, 7230, 7240, 7250, 8910, 8920, 8930, 8940, 8950 | 2A | 25/581-40 | 293624A1 1277261C1 | | 1" x 16 | 75 mm |
| | 2B | 25/581-41 | - | | à souder - to weld - Aanlaskogel - Anschweisskugel - para soldar | 115 mm |
| MX180, MX200, MX220, MX240, MX270 | 3 | 25/581-40 | 293624A1 1277261C1 | | 1" x 16 | 75 mm |



|  | Fig. | Part N° | OEM |
|---|------|------------|----------------------|
| 7210, 7220, 7230, 7240, 7250 (JJA0072001 ⇔), 8910, 8920, 8930, 8940, 8950 | 4 | 25/6450-34 | 231014A1 |
| 7210, 7220, 7230, 7240, 7250, 8910, 8920, 8930, 8940, 8950 | 5 | 25/6451-25 | 671032R1 671033R1 |

Les références des pièces sont indicatives.
Nos pièces ne sont pas d'origine.

Part numbers are quoted for reference purposes only.
Our parts and accessories are not original.



CASE IH PARTS

Pompes d'alimentation - Fuel pumps - Opvoerpompen -
Kraftstoffförderpumpen - Bombas de gas-oil





1



2

|  | Fig. | Ref. | OEM |
|---|------|-----------|--------------------------|
| 2120, 2130, 2140, 2150 PJ55, PJ65, PJ75, PJN55, PJN65, PJN75, PJV55, PJV65, PJV75 | 1 | 25/100-59 | 1966518C1 |
| 433, 440, 485XL, 495XL, 533, 540, 585, 585XL, 595, 595XL, 633, 640, 685, 685XL, 695, 695XL, 733, 740, 785XL, 795XL, 833, 840, 885, 885XL, 895, 933, 940, 995, 995XL, 3210, 3220, 3230, 4210, 4220, 4230, 4240 | 2 | 25/100-86 | 1202938C92 1202938C93 |

Pompe à eau - Water pump - Waterpomp - Wasserpumpe - Bomba de agua

|  |  | Part N° | OEM |
|--|---|------------|--------------------------|
| C55, C64, C70 (DBD0002501 ⇒), CS68, CS75 (⇒ DBD0023065), CS78, CS86, CS94 (⇒ DBD0010609) | MWM | 25/130-216 | 299671A1 130100060703 |



CASE IH PARTS

Filtration - Filters - Filters - Filter - Filtros



|  | 1 | 2 | 3 | 4 |
|---|---|--|---|---|
| | Filtre à air - Air intake - Luchtfilter - Luftfilter - Filtro de aire | Filtre à huile - Oil filter - Oliefilter - Ölfilter - Filtro de aceite | Filtre hydraulique - Hydraulic filter - Hydrauliekfilter - Hydraulik-Filter - Filtro hidráulica | Filtre hydraulique - Hydraulic filter - Hydrauliekfilter - Hydraulik-Filter - Filtro hidráulica |
| 2120, 2130, 2140, 2150 | 60/161-38 (1966965C1) | 60/97-36 (1966279C1, 325142A1) | 60/240-71 (114843A1) | 60/574-7 (114891A1) |
| PJ55, PJ65, PJ75, PJN55, PJN65, PJN75, PJV55, PJV65, PJV75 | | | | |



Contacteur à clef - Switch with key - Contactschakelaars - Zündschalter - Interruptor con llave

|  | Ref. | OEM |
|---|------------------|-----------------------|
| 2120, 2130, 2140, 2150, PJ55, PJ65, PJ75, PJN55, PJN65, PJN75, PJV55, PJV65, PJV75 | 25/950-10 | 1966930C1 449210A1 |



Jeu de mâchoires - Brake shoe kit - Remschoenenet - Bremsbacken - Juego zapatas



|  | Fig. | Part N° | OEM | Description - Description - Omschrijving - Beschreibung - Descripción |
|---|------|------------------|------------------------|---|
| 1255, 1455 (01/85 ⇨ 12/89) 1255XL (01/85 ⇨ 12/94) 1455XL (01/85 ⇨ 12/96) | 1 | 25/403-13 | 3233401R1 1964168C1 |  l = 80 mm |
| 1255, 1455 (01/79 ⇨ 12/85) 1255XL, 1455XL (01/81 ⇨ 12/85) | 2 | 25/403-14 | 3217704R1 |  l = 30 mm |

Les références des pièces sont indicatives.
Nos pièces ne sont pas d'origine.

Part numbers are quoted for reference purposes only.
Our parts and accessories are not original.



CASE IH PARTS

Arbre de prise de force - PTO Shaft - As PTO - Welle PTO - Eje de TDF

|  | Ref. | OEM |
|---|------------------|------------------------|
| 238, 248, 258, 268, 278, 288, 385, 395, 484, 485, 485XL, 495, 495XL, 584, 585, 585XL, 595, 595XL, 684, 685, 685XL, 695, 695XL, 784, 785, 785XL, 795, 795XL, 884, 885, 885XL, 895, 895XL, 995, 995XL, 3210, 3220, 3230, 4210, 4220, 4230, 4240, C50, C60, C70, C80, C90, C100, CX50, CX60, CX70, CX80, CX90, CX100 | 25/303-84 | 1500087C1 1502057C1 |



27 z

6 z - 1" ^{3/8}

Pompe hydraulique - Hydraulic pump - Hydrauliekpomp -
Hydraulikpumpe - Bomba hidráulica

|  | Ref. | OEM |
|---|------------------|------------------------|
| 2120, 2130, 2140, 2150 | 69/565-56 | 1530459C1 1967852C1 |









16 cm³ - U





CASE IH PARTS

Démarrreur - Starter motor - Startmotor - Anlasser - Motor de arranque

|  | Ref. | OEM |  |  A x B |  Z |  L |
|---|-------------------|-----------------------|---|--|---|---|
| 2140, 2150, PJ55, PJ65, PJ75, PJN55, PJN65, PJN75, PJV55, PJV65, PJV75 | 62/930-124 | 2873B056, 2873B071 | 12 V / 3.5 kW | 2x105  | 11Z | 254 mm |

Moteurs d'essuie-glace - Wiper motors - Ruitenwissermotor - Scheibenwischermotor - Motores limpiaparabrisas



|  | Fig. | Ref. | OEM | |
|---|----------|-------------------|--|--|
|  Fritzmeier | 1 | 63/1980-42 | 1089015R1 | 12 Volts - 135° Remplace / Replace BOSCH 0390506552 |
| 238, 248, 258, 268, 288, 385, 395, 485, 495, 585, 595, 685, 695, 785, 795, 885, 895 | 2 | 63/1980-45 | 1328080C91 3113074R91 3125203R91 | 12 Volts - 115° |



CASE IH PARTS

Radiateurs - Radiators - Radiatoren - Kühler - Radiadores



1



2



3



4



5



6

|  | Fig. | Part N° | OEM |
|---|------|-----------|--------------------------|
| 383, 423, 453 | 1 | 25/150-55 | 3131579R91 787141R92 |
| 433, 533, 540, 633, 640, 733, 833 | 2 | 25/150-53 | 3148115R93 3148115R94 |
| 644 | 3 | 25/150-52 | 3145499R91 3145499R92 |
| 733, 740 | 4 | 25/150-50 | 3233229R91 3233229R92 |
| 743, 744, 745 | 5 | 25/150-54 | 3145498R92 3145498R93 |
| 833, 840, 940 | 6 | 25/150-51 | 1328723C91 1328723C92 |
| 5120, 5130, 5140, 5150 | - | 25/150-56 | 104753A1 |

Les références des pièces sont indicatives.
Nos pièces ne sont pas d'origine.

Part numbers are quoted for reference purposes only.
Our parts and accessories are not original.





"THE RELIABLE SERVICE"

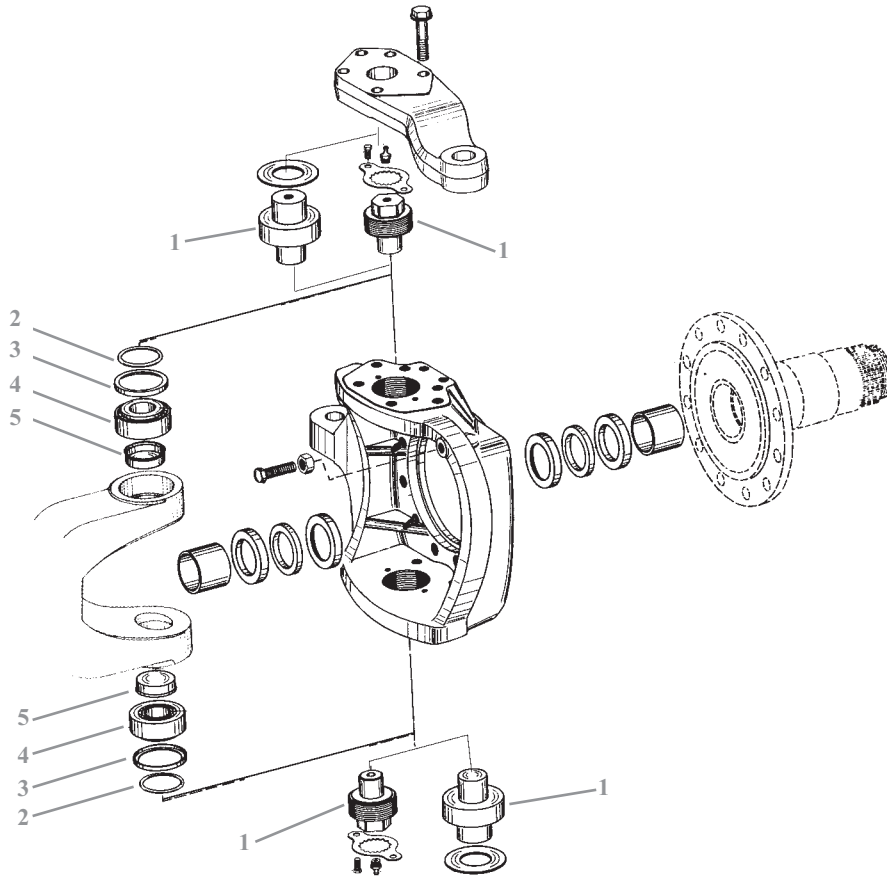

CASE IH - 4WD - ZF PARTS

Pivot d'essieu avant - Front axle pin - Vooras pen -
Vorderachsbolzen - Pasador para eje frontal



|  | ZF | Kit 1 ⇨ 5 | 1 | 2 | 3 | 4 | 5 |
|---|----------|--------------|---------------------------|--------------------------|--------------------------|---|--------------------------|
| 395, 485, 495, 585, 595 | APL 325 | 72/6454-1 KT | 25/6450-1 (81428C1) | 25/6452-23 (81419C1) | 25/6425-7 (81418C1) | 25/6451-23 (1342525C2) | 25/6425-9 (81415C1) |
| 485, 585, 685, 743, 785, 795, 844, 885, 895, 985, 995 | APL 330 | | 25/6450-3 (81305C1) | 25/6452-5 (81296C1) | 25/6425-8 (81295C1) | 25/6451-24 (81294C1) | 25/6425-10 (81293C1) |
| 685, 695, 743, 745, 745S, 785, 795, 844, 844S, 845, 856, 885, 895, 985, 995 | APL 335 | 72/6454-2 KT | 25/6450-31 (81670C1) | 25/6452-24 (81669C1) | 25/6425-1 (3147243R1) | 25/6451-1 (3147241R1+ 3147242R91) | 25/6425-11 (81667C1) |
| 956, 1056 | APL 345 | 72/6454-3 KT | 25/6450-12 (3216588R1) | 25/6452-5 (3147244R1) | | 25/6451-14 (1342526C2) | 25/6425-3 (3147245R1) |
| 533, 633, 733, 833, 933 | APL 1251 | 72/6454-4 KT | | | | | |
| 540, 640, 840, 940 | | 72/6454-5 KT | | | | | |
| 644, 743, 743XL, 744, 745S, 745XL, 844, 844S, 844XL, 856XL | APL 1351 | 72/6454-6 KT | 25/6450-13 (3147233R1) | 25/6452-5 (3147244R1) | 25/6425-1 (3147243R1) | 25/6451-1 (3147241R1+ 3147242R91) | 25/6425-3 (3147245R1) |
| 644, 744, 844, 844S | APL 1551 | 72/6454-7 KT | | | | | |
| 955, 955XL, 956, 956XL, 1055, 1055XL, 1056, 1056XL | APL1552 | | | | | | |
| 946, 1046 | APL 3050 | 72/6454-8 KT | 25/6450-14 (3146693R1) | 25/6452-6 (3146701R1) | 25/6425-2 (3134217R1) | 25/6451-5 (530741R1 + 400983R91) | 25/6425-4 (933085R1) |
| 644, 743, 743XL, 744, 745S, 745XL, 844, 844S, 844XL, 856XL, 946, 955, 955XL, 956, 956XL, 1046, 1055, 1055XL, 1056, 1056XL, 1246, 1255, 1255XL | APL 3052 | | | | | | |
| 1455, 1455XL | APL 3054 | | | | | | |
| | | | | | | | |

Les références des pièces sont indicatives.
Nos pièces ne sont pas d'origine.



Part numbers are quoted for reference purposes only.
Our parts and accessories are not original.



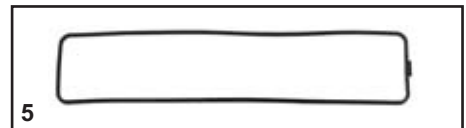
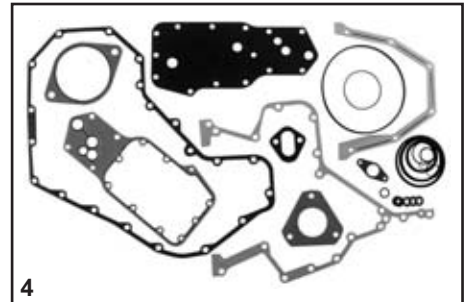
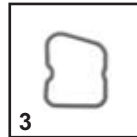
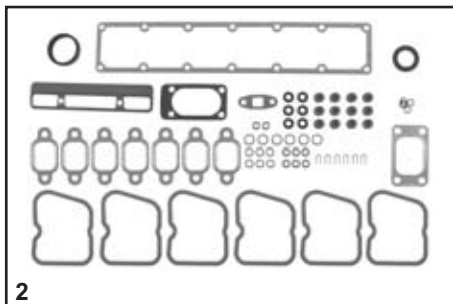
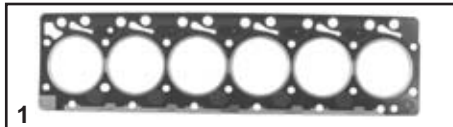

CASE-IH PARTS



Moteurs Cummins - Cummins engines - Cummins motortype -
Cummins Motore - Motores Cummins

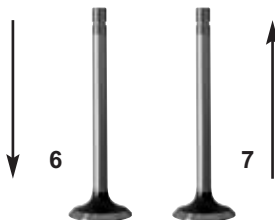

|  |  | 1 | 2 | 3 | 4 | 5 |
|---|---|-------------------------------|------------------------------|-------------------------------|------------------------------|---|
| 5120, 5120 Pro | 4 | 25/73-118 (J283333) | 25/76-118 (A77975) | 25/74-118 (J930906) | 25/72-118 (A77860) | 25/75-118 (A77673) |
| 5130, 5140, 5150 | 6 | 25/73-119 (J283335) | 25/76-119 (A77925) | | 25/72-119 (A77861) | 25/75-119 (A77676, A77979) |
| MX 100, MX 110, MX 120, MX 135, MX 150, MX 170 | 6 | | | | 25/72-120 (A77868) | |



|  | Fig. | Part N° | OEM |
|---|------|-----------------|---------|
| 5120, 5130, 5140, 5150, MX 100, MX 110, MX 120, MX 135, MX 150, MX 170 | 6 | 25/42-64 | J920867 |
| | 7 | 25/43-64 | J920868 |

|  |  | 8 | 9 |
|---|---|---|------------------------------|
| 5120 | 4 | 25/32-91 (A77733, A77730) | 25/35-91 (J904166) |
| 5140, 5150 | 6 | | |
| 5130 | 6 | 25/32-92 (A77410) | |
| MX 100, MX 110, MX 120, MX 135, MX 150, MX 170 | 6 | 25/32-93 (J802747 + J934047) | |



Les références des pièces sont indicatives.
Nos pièces ne sont pas d'origine.

Part numbers are quoted for reference purposes only.
Our parts and accessories are not original.



CASE-IH PARTS

Thermostat - Thermostat - Thermostaat - Thermostat - Termostato



|  | Part N° | OEM |
|---|------------------|--------|
| 5120, 5130, 5140, 5150, MX 100, MX 110, MX 120, MX 135, MX 150, MX 170 | 25/143-44 | A77736 |

Transmission avant - Front transmission - Transmissie vooraandrijving -
Antrieb Vorbau - Transmisión delantera



|  | Fig. | Part N° | OEM | |
|---|------|------------------|-----------------------|--|
| 238, 258, 268, 288, 395, 495(XL), 595(XL), 695(XL), 795(XL), 895(XL), 995XL (carraro with ZF transfer gearbox) 258, 685(XL), 743, 745S, 785(XL), 844S, 845, 856XL, 885(XL), (APL335) 956(XL), 1056(XL) (APL345) | 1 | 25/6447-6 | 90030C2 | Manchon d'entr. d'arbre de transm. avant Front drive shaft bush Voorwielaandrijving koppelstuk Buchse für Antriebswelle Casquillo estriado del eje delantero |
| 238, 248, 258, 268, 288, 395, 495(XL), 595(XL), 695(XL), 795(XL), 895(XL), 995XL (ZF with ZF transfer gearbox) 485, 585, 685(XL), 743, 745S, 785(XL), 844S, 845, 856XL, 885(XL) (APL330) | | 25/6447-7 | 90031C2 | |
| 238, 248, 258, 268, 288, 395, 485, 495(XL), 585, 595XL, 685(XL), 695(XL), 743(XL), 745S, 745XL, 785(XL), 795(XL), 844S, 844XL, 845(XL), 856XL, 885(XL), 895(XL), 956(XL), 995XL, 1056(XL), 485XL, 585XL (⇒ 734/APL330) | 2 | 25/6448-1 | 90088C1 | M12 x 45 |
| 238, 248, 258, 268, 288, 395, 495(XL), 595(XL), 695(XL), 743, 743XL, 745S, 745XL, 795(XL), 844S, 845XL, 856XL, 895, 956(XL), 995XL, 1056(XL), 3220, 3230, 4210, 4220, 4230, 4240 | 3 | 25/6429-1 | 82234C1 1537682C1 | |
| 238, 248, 258, 268, 288, 395, 485(XL), 495(XL), 585(XL), 595(XL), 685(XL), 695(XL), 743(XL), 745S, 745XL, 785(XL), 795(XL), 844S, 844XL, 845(XL), 856XL, 885(XL), 895, 956(XL), 995(XL), 1056(XL), 3210, 3220, 3230, 4210, 4220, 4230, 4240 | 4 | 25/6418-8 | 82236C92 1537681C1 | |

Les références des pièces sont indicatives.
Nos pièces ne sont pas d'origine.

Part numbers are quoted for reference purposes only.
Our parts and accessories are not original.



ZF PARTS

Pont avant "ZF" - "ZF" front axle - Vooras ZF - Vorderachse ZF - Eje ZF

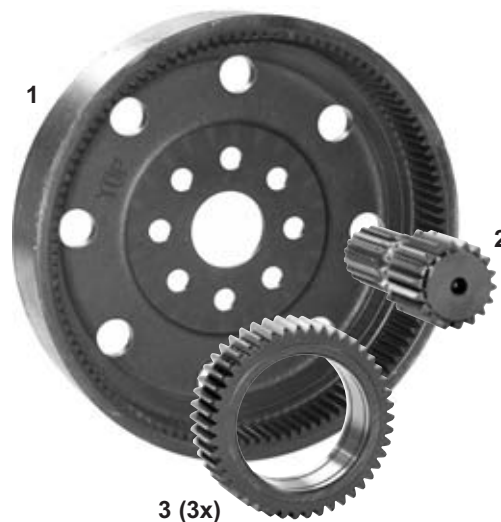

|  | ZF | Kits 1 -2 -3 |
|---|----------|---------------|
| Case IH Ford New Holland John Deere | APL 325 | 72/6428-1 KT |
| | APL 330 | 72/6428-2 KT |
| | APL 335 | 72/6428-3 KT |
| | APL 345 | 72/6428-4 KT |
| | APL 350 | 72/6428-5 KT |
| | APL 1251 | 72/6428-6 KT |
| | APL 1351 | 72/6428-7 KT |
| | APL 1551 | 72/6428-8 KT |
| | APL 1552 | 72/6428-9 KT |
| | APL 3054 | 72/6428-10 KT |





CASE-IH PARTS

Pompe d'alimentation - Fuel pump - Opvoerpomp -
Kraftstofförderpumpe - Bomba de gas-oil

|  | Ref. | OEM |
|--|------------------|----------|
| CS 68, CS 75, CS 78, CS 86, CS 94, CS 110, CS 120, CS 130, CS 150, CVX 120, CVX 130, CVX 150, CVX 170, 9105, 9115, 9125, 9145 | 25/100-78 | 354236A1 |





Courroie - Belt - Snaar - Keilriemen - Correa

|  | Ref. | OEM |
|---|-------------------|---------|
| 7110E, 7120E, 7130, 7140, 7210, 7220, 7230, 7240, 7250, STX 275, STX 325 | 25/144-140 | J911567 |



Disques de frein à bain d'huile - Brake discs (oil bath) - Remschijven (oliebad) -
Scheiben (Öbad) - Disco de freno (en bañ de aceite)



|  | Fig. | Ref. | OEM | Ø mm | A | |
|---|------|------------------|--------------|------|----------------|---|
| CS110, CS120, CS130, CS150 | 1 | 25/422-31 | 155700340029 | 222 | 28Z 56x60mm |  |
| | 2 | 25/423-15 | 155700340030 | 227 | |  |

Les références des pièces sont indicatives.
Nos pièces ne sont pas d'origine.





Part numbers are quoted for reference purposes only.
Our parts and accessories are not original.

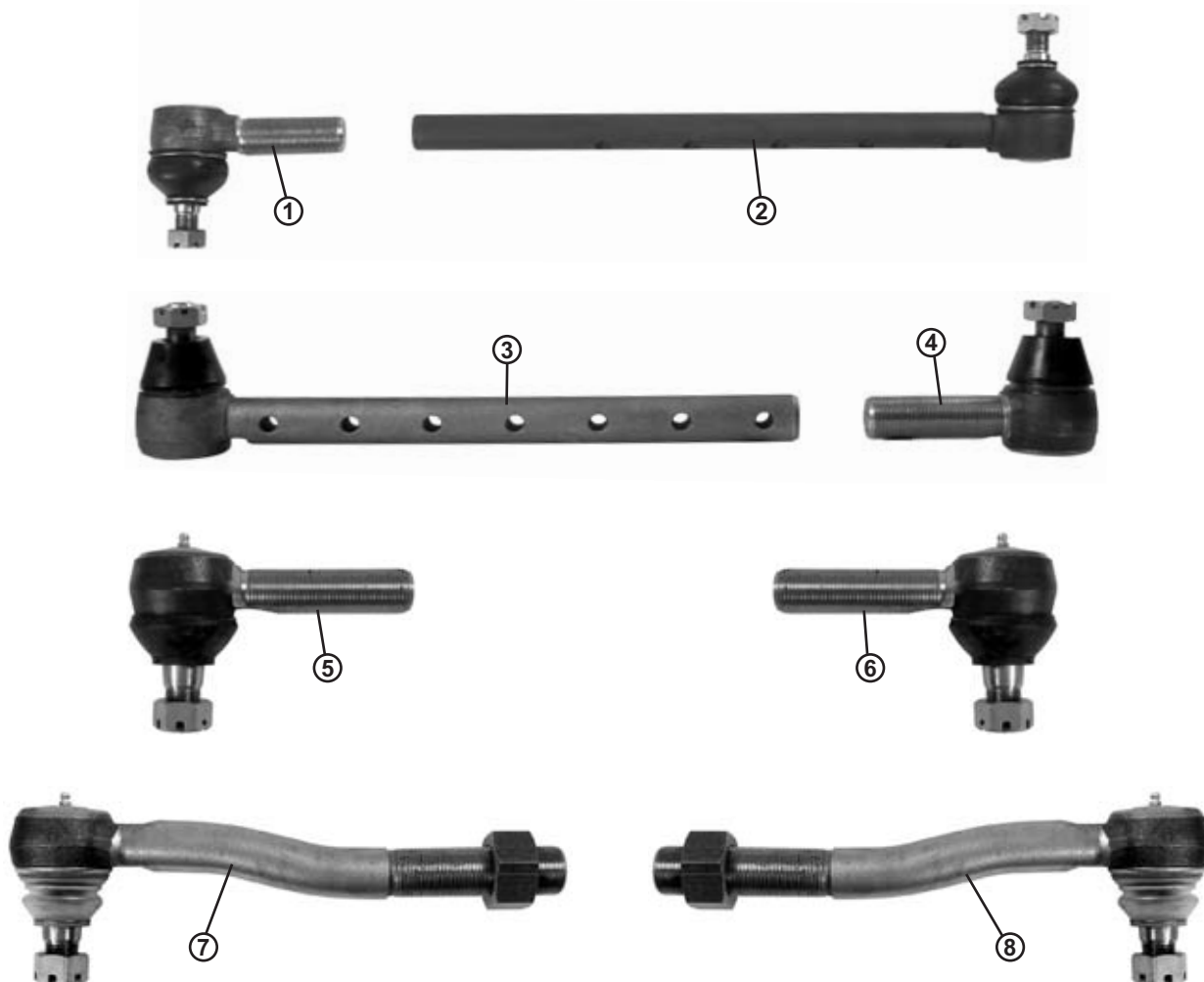

CASE-IH PARTS

Rotules & tirants de direction - Steering links & sockets - Stuurkogels en stangen - Kugelgelenke und Spurstangen - Rótulas y acoples de dirección



|  | Fig. | Ref. | OEM |  |  mm |  |
|--|------|-----------|-----------|---|---|---|
| 3210, 3220, 3230, 4210, 4220, 4230, 4240, C50, C60, C70, C80, C90, C100, CX50, CX60, CX70, CX80, CX90, CX110, MX80, MX90, MX100 (2 WD) | 1 | 25/491-26 | 1537872C1 | M 7/8" RH | 92 | 5/8" x 11/16" |
| | 2 | 25/496-17 | 1332805C2 | Ø 13/16" | 360 | 5/8" x 11/16" |
| MX100, MX110, MX120, MX135, MX150, MX170, MX180, MX200, MX220, MX240, MX270 (2 WD) | 3 | 25/491-25 | 1280662C1 | Ø 30 mm | 385 | 25 x 28 mm |
| | 4 | 25/492-24 | 1280658C1 | M 1 1/8" RH | 120 | 25 x 28 mm |
| 7110, 7120, 7130, 7140 (4 WD) | 5 | 25/491-28 | 1277452C1 | M 1 1/8" LH | 140 | 24.5 x 28 mm |
| | 6 | 25/492-19 | 1277451C1 | M 1 1/8" RH | 140 | 24.5 x 28 mm |
| 7110, 7120, 7130, 7140, 7210, 7220, 7230, 7240, 7250 (4 WD) | 7 | 25/491-27 | 128609A1 | M 1 1/4" LH | 315 | 24.5 x 28 mm |
| | 8 | 25/492-18 | 128604A1 | M 1 1/4" RH | 315 | 24.5 x 28 mm |

Les références des pièces sont indicatives.
Nos pièces ne sont pas d'origine.

Part numbers are quoted for reference purposes only.
Our parts and accessories are not original.



CASE-IH PARTS

Attelage - Linkage - Aanspan-delen - Zugpendel - Enganches

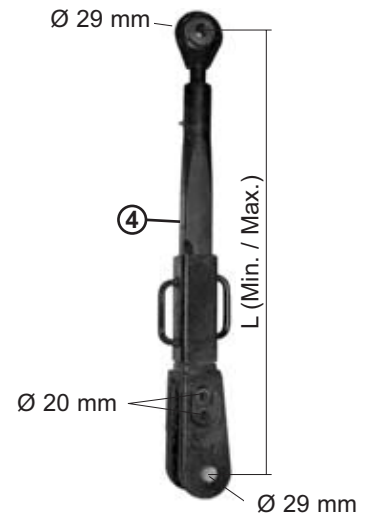
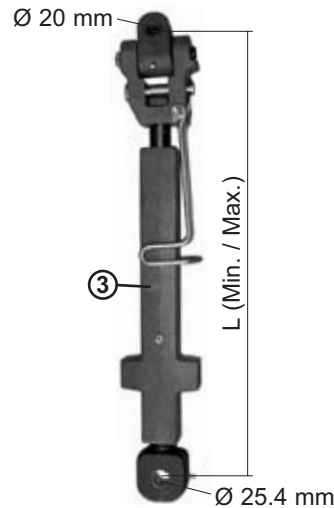
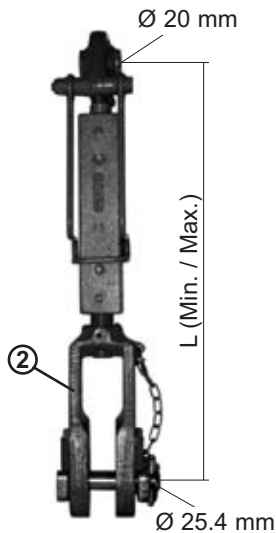
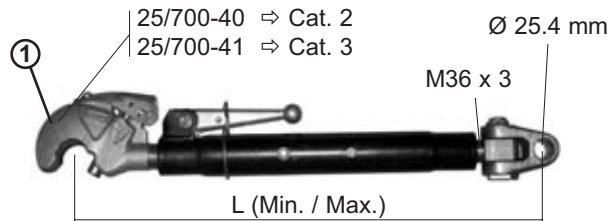

|  | Fig. | Ref. | OEM | Désignation - Description - Omschrijving - Beschreibung - Descripción |
|---|------|-----------|-----------|--|
| Maxxum | 1 | 25/700-40 | 1348048C2 | 3ème point - Top link - Topstang - Oberlenker - Tercer punto Cat. 2 L = 610-880 mm |
| | | 25/700-41 | | 3ème point - Top link - Topstang - Oberlenker - Tercer punto Cat. 3 L = 626-896 mm |
| Maxxum | 2 | 25/760-64 | | Tirant de relevage - Levelling box assembly - Hefstangen - Hubstangen - Horquilla y caja niveladora L = 530-675 mm |
| Magnum | 3 | 25/760-65 | | Tirant de relevage - Levelling box assembly - Hefstangen - Hubstangen - Horquilla y caja niveladora L = 620-835 mm |
| MX150, MX170 | 4 | 25/760-66 | 241417A3 | Tirant de relevage - Levelling box assembly - Hefstangen - Hubstangen - Horquilla y caja niveladora L = 900-1080 mm |

Les références des pièces sont indicatives.
Nos pièces ne sont pas d'origine.

Part numbers are quoted for reference purposes only.
Our parts and accessories are not original.



CASE-IH PARTS

Durites de radiateur - Radiator hoses - Radiatorslangen - Kühlerschläuche - Manguitos radiator



1



2

|  | Fig. | Ref. | OEM | Désignation - Description - Omschrijving - Beschreibung - Descripción |
|---|------|-------------------|---------|---|
| Maxxum | 1 | 25/153-125 | T103198 | Supérieure - Top - Boven - Oben - Superior |
| | 2 | 25/154-125 | T103197 | Inférieure - Bottom - Onder - Unten - Inferior |

Arbre de prise de force - PTO Shaft - As PTO - Welle PTO - Eje de TDF

|  | Ref. | OEM |
|---|------------------|-----------|
| 844XL, 856XL, 956, 956XL, 1056, 1056XL | 25/303-97 | 3402751R1 |



Éléments de cabine - Cab elements - Kabinelementen - Kabinenzubehö - Elementos de cabina



1

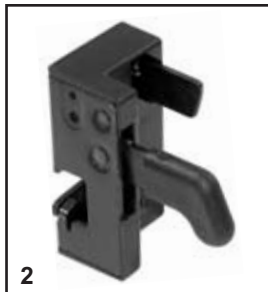

2









3



4



5

|  | Fig. | Ref. | OEM | Désignation - Description - Omschrijving - Beschreibung - Descripción |
|---|------|-------------------|-----------|--|
| 440, 540, 640, 3210, 3220, 3230, 4210, 4220, 4230, 4240 (⇒ JJE0926239) ( LP), 5120, 5130, 5140 (⇒ JJF1020699) | 1 | 70/4170-91 | 1971204C1 | Poignée - Handle - Klink - Griff - Pomo |
| 595XL, 695XL, 743XL, 745XL, 795XL, 844XL, 845XL, 856XL ( XLN) 3210, 3220, 3230, 4210, 4220, 4230, 4240 ( LP) | 2 | 70/4170-92 | 1535126C1 | Serrure gauche - LH lock - Slot (links) - Schloss (links) - Cerradura izda. |
| | | 70/4170-93 | 1535127C1 | Serrure droite - RH lock - Slot (rechts) - Schloss (rechts) - Cerradura drcha. |
| 3210, 3220, 3230, 4210, 4220, 4230, 4240 (JJE0926240 ⇒) ( LP) | 3 | 70/4170-94 | 255195A1 | Poignée - Handle - Klink - Griff - Pomo |
| 4210, 4220, 4230, 4240 (JKJ156937 ⇒) ( XL) | 4 | 70/4170-95 | 224736A1 | Poignée de vitre arrière - Rear glass handle - Slot achterruit - Griff Heckscheibe - Pomo de cristales trasero |
| 5120, 5130, 5140, 5150 | 5 | 70/4170-96 | 224730A1 | Poignée de vitre arrière - Rear glass handle - Slot achterruit - Griff Heckscheibe - Pomo de cristales trasero |

Les références des pièces sont indicatives.
Nos pièces ne sont pas d'origine.

Part numbers are quoted for reference purposes only.
Our parts and accessories are not original.



CASE-IH PARTS

Pistons, jeu de segments & chemises - Pistons, ring sets & liners -
 Zuigers, zuigerveren & cilinderbussen - Kolben, buchsen und Ringe -
 Pistones, juegos de anillos, y camisas

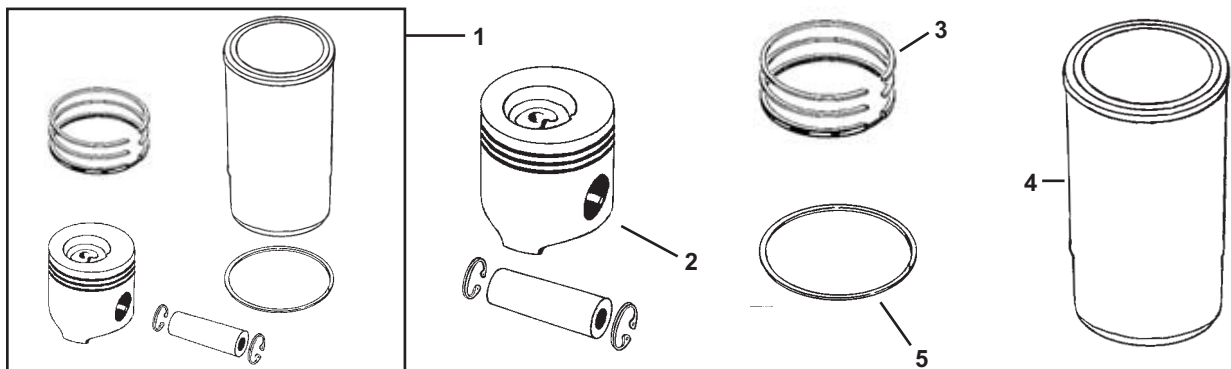

| |  | 1 | 2 | 3 | 4 | 5 |
|------|---|---|-----------|------------------------------------|-------------------------|-------------------------------------|
| | | 1 ^{er} montage 1 st fitting | | | | |
| D179 | 98.4 mm | 25/31-65 (3139591R96) | 25/33-65 | 25/34-65 (3139594R91) AL FIN | 25/35-63 (3139592R4) | 25/38-62 (3228344R1) Ø 5.0 mm |
| D239 | | 2 ^{ème} montage (A) 2 nd fitting | | | | |
| D358 | | 25/31-185 (1806470C91) | 25/33-185 | | | 25/38-63 (3228348R1) Ø 4.7 mm |

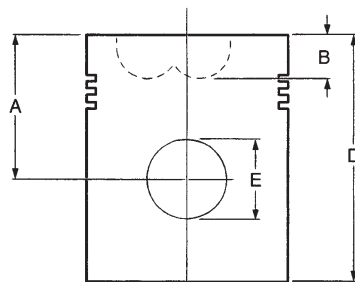
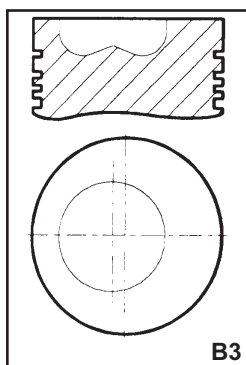

- A: Hauteur de compression (mm)
Compression height (mm)
- B: Profondeur chambre combustion (mm)
Combustion bowl depth (mm)
- D: Hauteur totale (mm)
Overall length (mm)
- E: Diamètre de l'axe de piston (mm)
Gudgeon pin diameter (mm)

| Réf. Ref. |  |  | Type Type |  | Al-fin Al-fin | A | B | D | E |
|--------------|---|---|--------------|---|------------------|-------|-------|--------|-------|
| 25/33-65 | D179 | 98.4 mm | B3 | 3 | Oui Yes | 67.00 | 24.00 | 107.00 | 36.00 |
| 25/33-185 | D239 | | | | | | 22.10 | | |
| | D358 | | | | | | | | |

(A) Avec pompe d'injection électrique (type VE) / With electrical injection pump (VE type)



CASE-IH PARTS



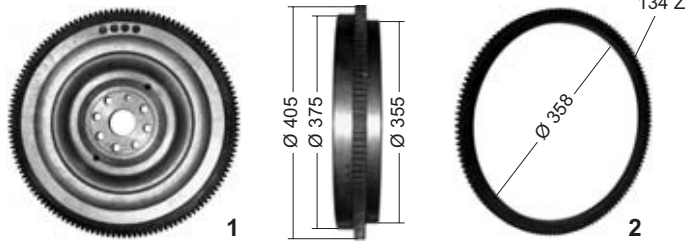

Volant moteur - Flywheel - Vliegwiel - Schwungrad - Volante motor

|  | Fig. | Ref. | OEM |
|---|------|----------|-------------------------|
| 743, 745 S, 844, 844 S, 844 XL, 845, 845 XL | 1 | 25/296-6 | 3144651R92 |
| | 2 | 25/15-9 | 3055133R1, 3144607R1 |



Contacteur - Starter switch - Startschakelaar - Schalter - Interruptor



|  | Fig. | Ref. | OEM |  | Positions - Positions - Standen - Positionen - Posiciones |
|---|------|-----------|---------------------------|--|---|
| MAXXUM 5120, 5130, 5140, 5150 | 1 | 25/950-33 | 1987424C1 | 10 | 1 Parking 2 0 3 Contact 4  5 Start |
| | 2 | 25/951-33 | 1964831C2 | | |
| C42, C48, C55, C64, C70, CS68, CS75 | 3 | 25/950-35 | 135700580118 | 10 | 1 Parking 2 0 3 Contact 4  5 Start |
| | 4 | 25/951-34 | 135700580706 1533739C1 | | |
| CS78, CS86, CS94, CS110, CS120, CS130, CS150, CVX120, CVX130, CVX150, CVX170 | 5 | 25/950-34 | 140258008 | 6 | 1 0 2  3 Start |
| | 4 | 25-951-34 | 135700580706 1533739C1 | | |

Arbre de prise de force - PTO Shaft - As PTO - Welle PTO - Eje de TDF

|  | Ref. | OEM |
|---|-----------|--------------|
| CS 110, CS 120, CS 130, CS 150, CVX 120, CVX 130, CVX 150, CVX 170 | 25/303-81 | 133000270156 |



Les références des pièces sont indicatives.
Nos pièces ne sont pas d'origine.

Part numbers are quoted for reference purposes only.
Our parts and accessories are not original.



CASE-IH PARTS

Rétroviseur - Mirror - Spiegel - Spiegel - Retrovisor

|  | Ref. | OEM |
|---|-------------|-----------|
| C 55, C 64, C 70, Serie CS, CVX | 25/4172-176 | 134677017 |



Pompe hydraulique (relevage) - Hydraulic pump (hydr. lift) - Hydrauliekpomp (lift) - Hydraulikpumpe (lift) - Bomba hidráulica (elevador)

|  | Fig. | Ref. | OEM | CC |
|---|------|------------|--------------|---------|
| CS 110, CS 120, CS 130, CS 150 | 1 | 69/565-102 | 1-32-575-005 | 32 |
| | 2 | 69/565-122 | 1-32-575-003 | 38 + 16 |



Vérin de direction - Steering cylinder - Stuercilinder - Lenkhiłszylinder - Cilindro de dirección

|  | Ref. | OEM |
|--|----------|-----------------------|
| 238, 248, 258, 288, 454, 474, 475, 484, 574, 584, 674, 684, 784, 884, 385, 485, 485 XL, 585, 585 XL, 685, 685 XL, 785, 785 XL, 885, 885 XL, 395, 495, 495 XL, 595, 595 XL, 695, 695 XL, 795, 795 XL, 895, 895 XL, 995 XL, 3210, 3220, 3230, 4210, 4220, 4230, 4240, C 50, C 60, C 70, C 80, C 90, C 100, CX 50, CX 60, CX 70, CX 80, CX 90, CX 100 MX 80 C, MX 90 C, MX 100 C | 25/580-9 | 188842A1 549667R93 |

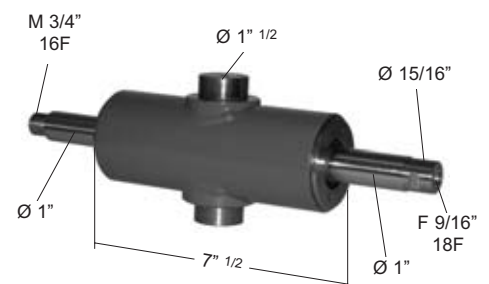

Les références des pièces sont indicatives.
Nos pièces ne sont pas d'origine.

Part numbers are quoted for reference purposes only.
Our parts and accessories are not original.



CASE-IH PARTS



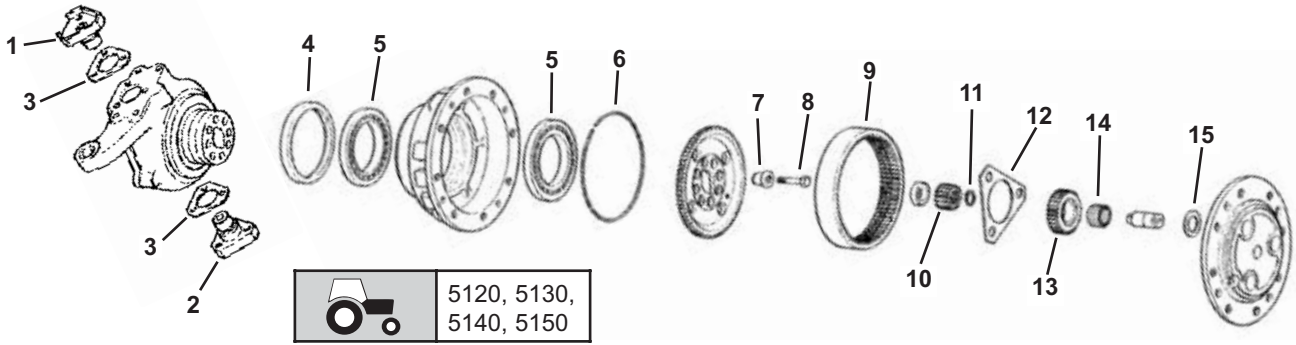

Pont avant "Carraro" - "Carraro" front axle - Vooras Carraro - Vorderachse Carraro - Eje Carraro

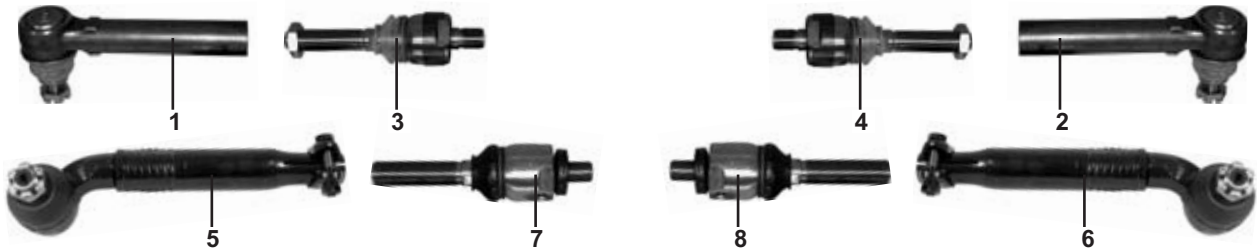

| Fig. | Ref. | OEM | Fig. | Ref. | OEM | Fig. | Ref. | OEM |
|------|------------|------------------|------|------------|-----------------|------|------------|----------|
| 1 | 25/6450-18 | 1995414C1 | 5 | 25/6410-32 | K395101,81676C1 | 11 | 25/6434-19 | K261897 |
| 2 | 25/6450-19 | N13504 | 6 | 25/6436-3 | H437679 | 12 | 25/6401-15 | K395122 |
| 3 | 25/6453-28 | K395036 (0.10mm) | 7 | 25/451-12 | 107071A1 | 13 | 25/6431-16 | N13513 |
| 3 | 25/6453-29 | K395037 (0.19mm) | 8 | 25/452-17 | K395131 | 14 | 25/6433-11 | 119686A1 |
| 3 | 25/6453-30 | K395038(0.35mm) | 9 | 25/6430-18 | H437677 | 15 | 25/384-8 | K395091 |
| 4 | 25/6408-29 | 247877A1,K395102 | 10 | 25/6406-20 | K395114 | | | |

Tirants et accouplements de direction 4 roues motrices - Steering coupling 4 wheel drive - Spoorstangeind & scharniergewricht 4 WD tractoren - Spurstang & Kugelgelenk 4-Rad-Traktoren - Rótulas y acoples de dirección para tractores con doble tracción



|  | Fig. | Ref. | OEM |  |  |  |
|---|-------|------------|-----------|---|---|---|
| CS 78, CS 86, CS 94 | 1 | 25/495-230 | 133743601 | F 18 x 1.5 LH | 140 mm | 20 x 22 |
| | 2 | 25/495-231 | 133743603 | F 18 x 1.5 RH | 140 mm | 20 x 22 |
| | 3 | 25/497-177 | 133743602 | M 18 x 1.5 LH M 20 x 1.5 RH | 175 mm | |
| | 4 | 25/497-178 | 133743604 | M 18 x 1.5 RH M 20 x 1.5 RH | 175 mm | |
| CS 110, CS 120, CS 130, CS 150 (1 ^{ère} série / 1 st serie) | 5 | 25/495-232 | 133743611 | F 24 x 1.5 RH | 240 mm | 23.5 x 26 |
| | 6 | 25/495-233 | 133743614 | F 24 x 1.5 RH | 240 mm | 23.5 x 26 |
| | 7 - 8 | 25/497-141 | 133743613 | M 24 x 1.5 RH M 20 x 1.5 RH | 210 mm | |
| CS 110, CS 120, CS 130, CS 150 (2 ^{ème} série / 2 nd serie) | 5 | 25/495-234 | 133743617 | F 24 x 1.5 RH | 280 mm | 23.5 x 26 |
| | 6 | 25/495-235 | 133743619 | F 24 x 1.5 RH | 280 mm | 23.5 x 26 |
| | 7 - 8 | 25/497-141 | 133743613 | M 24 x 1.5 RH M 20 x 1.5 RH | 210 mm | |

Les références des pièces sont indicatives.
Nos pièces ne sont pas d'origine.

Part numbers are quoted for reference purposes only.
Our parts and accessories are not original.



CASE-IH PARTS

Nez d'injecteur - Injector nozzle - Verstuiver - Einspritzdüse - Tobera

|  | Ref. | OEM |
|---|-------------------|--------------------|
| Magnum 7140, 7240 | 25/117-131 | J908513, A77700 |



Tendeur de courroie - Belt tensioner - Spanner - Keilriemenspanner - Tensor

|  | Ref. | OEM |
|--|-----------------|---|
| Maxxum 5120, 5130, 5140, 5150, Magnum 7110, 7120, 7130, 7140, 7210, 7220, 7230, 7240, 7250, MX 100, 110, 120, 135, 150, 170, 180, 200, 220, 240, 270 | 25/135-1 | J918944, J934817, J936202, J936203 |



Moteurs chauffage de cabine - Cab heater motors - Kabinen-heizung -
Kabineverwarming - Motores de calefacción de cabina





|  | Fig. | Ref. | OEM |
|---|----------|------------------|-----------|
| Cabine - Cab - Kabine - Kabine - Cabina XL | 1 | 25/1988-1 | 1974779C1 |
| Cabine - Cab - Kabine - Kabine - Cabina Confort 2000 | 2 | 25/1988-9 | 3223815R1 |

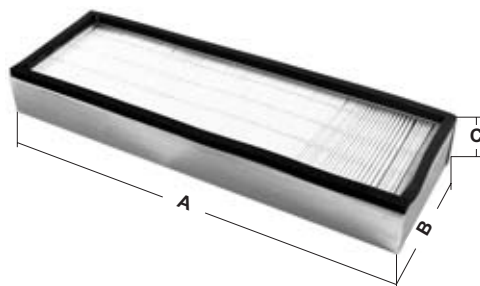

CASE-IH PARTS

Filtres de cabine - Cab filters - Kabinesfilter - Kabinenfilter - Filtros de cabina



|  | Ref. | OEM | A x B x C |
|---|-------------------|--------------------------------|----------------|
| Séries 43, 44, 45 Series Cabine - Cab - Kabine - Kabine - Cabina Comfort | 60/4200-26 | 3223808R1 | 420 x 140 x 55 |
| 5120, 5130, 5140, 5150, 7210, 7220, 7230, 7240, 7250 | 60/4200-27 | 143481C2 131413C1 A45573 | 965 x 152 x 55 |

Amortisseurs - Shock absorbers - Onderleggers - Gummidaempfern - Amortiguadores

|  | Fig. | Ref. | OEM |
|---|----------|-------------------|-----------|
| Cabine - Cab - Kabine - Kabine - Cabina XL | 1 | 25/4114-15 | 3399959R1 |
| | 2 | 25/4114-16 | 3399961R1 |



Les références des pièces sont indicatives.
Nos pièces ne sont pas d'origine.

Part numbers are quoted for reference purposes only.
Our parts and accessories are not original.



CASE IH - 4WD - ZF parts

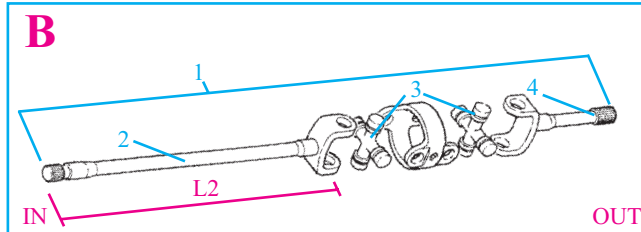
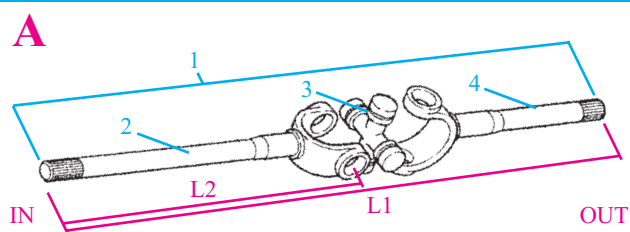

| | | 1 - LH | 1 - RH | 2 - LH | 2 - RH | 3 | 4 |
|---|-------------------------|---|--|---|---|--|-----------------------------------|
| Case-IH (Europe) | | | | | | | |
| 533, 633, 733, 833, 933, 540, 640, 740, 840, 940 | APL 1251 A | | | 25/6405-11 (3216600R91) L2=352mm | 25/6405-12 (3216602R91) L2=786mm | 25/6403-7 (3230277R1) | 25/6405-33 (3216599R91) |
| | APL 1251 B | | | 25/6405-13 (89522C1) L2=352mm | 25/6405-14 (89525C1) L2=786mm | 25/6403-20 (K965215) | 25/6405-34 (89521C1) |
| 644, 743, 743XL, 744, 745S, 745XL, 844, 844S, 844XL, 856XL | APL 1351 A | | | 25/6405-15 (3230276R1) | 25/6405-16 (3230278R1) | 25/6403-7 (3230277R1) | 25/6405-33 (3216599R91) |
| 644, 744, 844, 844S | APL 1551 A | 25/6402-14 (3147219R91) L1=615mm | 25/6402-22 (3147217R91) L1=1127mm | | | | 25/6405-35 (3404366R1) |
| 955, 955XL, 956, 956XL, 1055, 1055XL, 1056, 1056XL | APL 1552 A | 25/6402-15 (3230316R1) | 25/6402-23 (3230317R1) | 25/6405-17 (3404369R1) | 25/6405-18 (3404367R1) | 25/6403-18 (3224325R1) | 25/6405-36 (1975567C1) |
| | APL 1552 B | 25/6402-16 (1975554C1) | 25/6402-24 (1975557C1) | 25/6405-19 (1975555C1) | 25/6405-20 (1975558C1) | 25/6403-20 (K965215) | 25/6405-37 (1975556C1) |
| 644, 743, 743XL, 744, 745S, 745XL, 844, 844S 844XL, 856XL, 946, 955, 955XL, 956, 956XL, 1046, 1055, 1055XL, 1056, 1056XL, 1246 | APL 3052 A | 25/6402-17 (3146678R91) | 25/6402-25 (3146679R91) | 25/6405-21 (3230388R1) L2=350mm | 25/6405-22 (3230387R1) L2=794mm | 25/6403-47 (3224326R1) | 25/6405-38 (3230386R1) |
| | APL 3052 B | | | | | 25/6403-16 (1975562C1, 1975563C1) | 25/6405-39 (1975565C1) |
| 1255, 1255XL | APL 3052 A | 25/6402-19 (3229120R1) | 25/6402-27 (3229121R1) | 25/6405-25 (1975572C1) | 25/6405-26 (1975573C1) | 25/6403-47 (3224326R1) | 25/6405-38 (3230386R1) |
| | APL 3052 B | 25/6402-20 (1975568C1) | 25/6402-28 (1975570C1) | 25/6405-27 (1975569C1) | 25/6405-28 (1975571C1) | | 25/6405-39 (1975565C1) |
| 1455, 1455XL | APL 3054 B | 25/6402-21 (3405264R1) | 25/6402-29 (3405265R1) | 25/6405-29 (1975574C1) | 25/6405-30 (1975576C1) | 25/6403-16 (1975562C1, 1975563C1) | 25/6405-40 (1975575C1) |
| Case-IH (UK) | | | | | | | |
| 258, 268, 278, 485XL, 584, 585, 585XL, 684, 685, 685XL, 784, 785, 785XL, 884, 885, 885XL, 85Hydro | APL 1351 A | | | 25/6405-31 (1502265C1) | 25/6405-32 (1502267C1) | 25/6403-7 (3230277R1) | 25/6405-33 (3216599R91) |

Les références de pièces sont indicatives.
Nos pièces ne sont pas d'origines

Parts numbers are quoted for reference purposes only.
Our parts and accessories are not original



CASE IH - 4WD - ZF parts

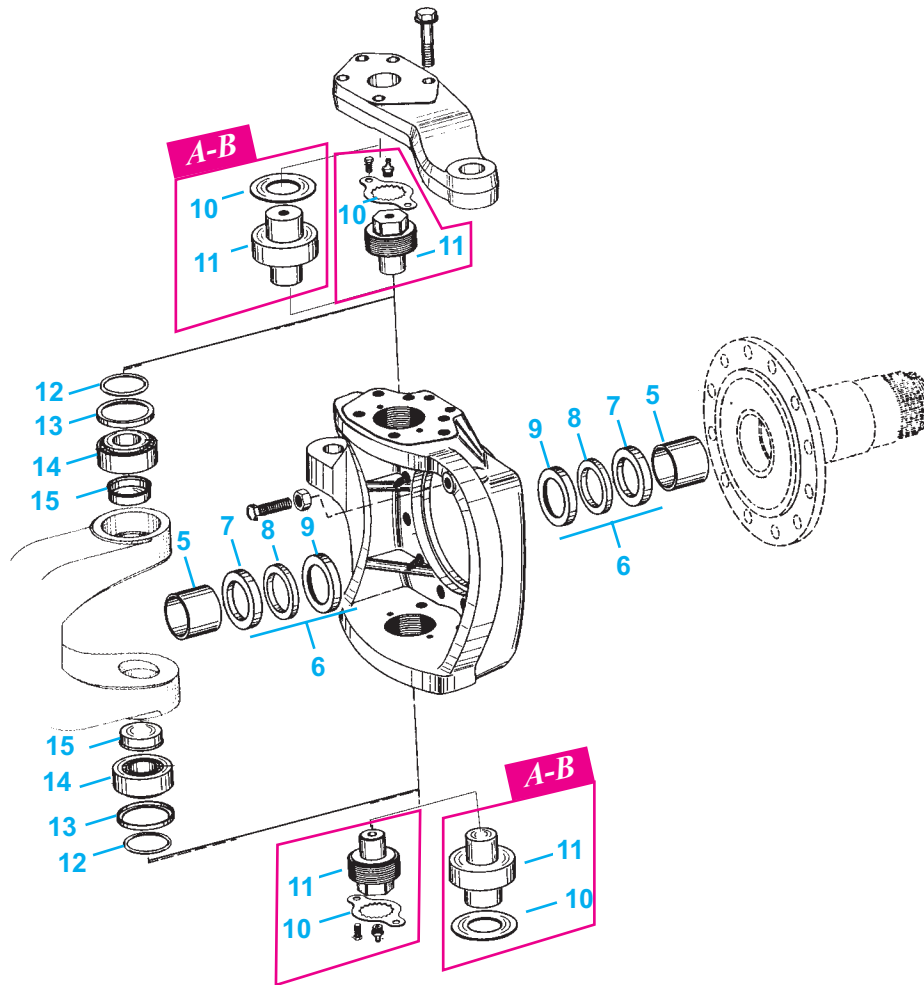



| | | 5 | 6 | 7 | 8 | 9 |
|---|-------------|--|--|----------------------------------|---|---|
| Case-IH (Europe) | | | | | | |
| 533, 633, 733, 833, 933, 540, 640, 740, 840, 940 | APL 1251 | 25/6462-9 (3216585R1) | 25/6407-8 (3405555R2) | 25/6407-9 (3226006R1) | 25/6407-11 (3226009R1) | 25/6407-14 (3226008R1) |
| 644, 743, 743XL, 744, 745S, 745XL, 844, 844S, 844XL, 856XL | APL 1351 | | | | | |
| 644, 744, 844, 844S | APL 1551 | 25/6462-10 (3147216R1) | 25/6407-20 (3224343R1, 3224342R1) | | 25/6407-12 (3224344R1) | 25/6407-15 (3224345R1) |
| 955, 955XL, 956, 956XL, 1055, 1055XL, 1056, 1056XL | APL 1552 | | | | | |
| 644, 743, 743XL, 744, 745S, 745XL, 844, 844S, 844XL, 856XL, 946, 955, 955XL, 956, 956XL, 1046, 1055, 1055XL, 1056, 1056XL, 1246, 1255, 1255XL | APL 3052 | ⇒ 5027 25/6462-11 (3216500R1) | | 25/6407-10 (3223862R1) | 25/6407-13 (3223864R1, 340628A1) | 25/6407-16 (3223863R1, 340626A1) |
| 1455, 1455XL | APL 3054 | 5028 ⇒ 25/6462-12 (3146683R1) | | | | |
| Case-IH (UK) | | | | | | |
| 258, 268, 278, 485XL, 584, 585, 585XL, 684, 685, 685XL, 784, 785, 785XL, 884, 885, 885XL, 85Hydro | APL 1351 | 25/6462-9 (3216585R1) | 25/6407-8 (3405555R2) | 25/6407-9 (3226006R1) | 25/6407-11 (3226009R1) | 25/6407-14 (3226008R1) |

Les références de pièces sont indicatives.
Nos pièces ne sont pas d'origines

Parts numbers are quoted for reference purposes only.
Our parts and accessories are not original

CASE IH - 4WD - ZF parts

| | | 10 | 11 | 12 | 13 | 14 | 15 |
|---|-------------|--|----------------------------------|---------------------------------|---------------------------------|--|---------------------------------|
| Case-IH (Europe) | | | | | | | |
| 533, 633, 733, 833, 933 | APL 1251 | 25/6453-1 (3216589R1) | 25/6450-12 (3216588R1) | 25/6452-5 (3147244R1) | 25/6425-1 (3147243R1) | 25/6451-1 (3147241R1+ 3147242R91) | 25/6425-3 (3147245R1) |
| 540, 640, 740, 840, 940 | | | | | | 25/6451-14 (1342526C2) | |
| 644, 743, 743XL, 744, 745S, 745XL, 844, 844S, 844XL, 856XL | APL 1351 |  | 25/6450-13 (3147233R1) | 25/6452-5 (3147244R1) | 25/6425-1 (3147243R1) | 25/6451-1 (3147241R1+ 3147242R91) | 25/6425-3 (3147245R1) |
| 644, 744, 844, 844S | APL 1551 | | | | | | |
| 955, 955XL, 956, 956XL, 1055, 1055XL, 1056, 1056XL | APL 1552 | | | | | | |
| 946, 1046 | APL 3050 |  | 25/6450-14 (3146693R1) | 25/6452-6 (3146701R1) | 25/6425-2 (3134217R1) | 25/6451-5 (530741R1+ 400983R91) | 25/6425-4 (933085R1) |
| 644, 743, 743XL, 744, 745S, 745XL, 844, 844S 844XL, 856XL, 946, 955, 955XL, 956, 956XL, 1046, 1055, 1055XL, 1056, 1056XL, 1246, 1255, 1255XL | APL 3052 | | | | | | |
| 1455, 1455XL | APL 3054 | | | | | | |
| Case-IH (UK) | | | | | | | |
| 258, 268, 278, 485XL, 584, 585, 585XL, 684, 685, 685XL, 784, 785, 785XL, 884, 885, 885XL, 85Hydro | APL 1351 | 25/6453-1 (3216589R1) | 25/6450-12 (3216588R1) | 25/6452-5 (3147244R1) | 25/6425-1 (3147243R1) | 25/6451-1 (3147241R1+ 3147242R91) | 25/6425-3 (3147245R1) |

| A | | | |
|----------|-------------------|-----------|--|
| 2.60 | 25/6453-2 | 3147240R1 | |
| 2.70 | 25/6453-3 | 3147239R1 | |
| 2.75 | 25/6453-4 | 3230308R1 | |
| 2.80 | 25/6453-5 | 3147238R1 | |
| 2.85 | 25/6453-6 | 3230307R1 | |
| 2.90 | 25/6453-7 | 3147237R1 | |
| 2.95 | 25/6453-8 | 3230306R1 | |
| 3.00 | 25/6453-9 | 3147236R1 | |
| 3.05 | 25/6453-10 | 3230305R1 | |
| 3.10 | 25/6453-11 | 3147235R1 | |
| 3.15 | 25/6453-12 | 3230304R1 | |
| 3.20 | 25/6453-13 | 3147234R1 | |
| 3.30 | 25/6453-14 | 3230303R1 | |

| B | | | |
|----------|-------------------|-----------|--|
| 2.60 | 25/6453-15 | 3146700R1 | |
| 2.70 | 25/6453-16 | 3146699R1 | |
| 2.75 | 25/6453-17 | 3147889R1 | |
| 2.80 | 25/6453-18 | 3146698R1 | |
| 2.85 | 25/6453-19 | 3147888R1 | |
| 2.90 | 25/6453-20 | 3146697R1 | |
| 2.95 | 25/6453-21 | 3147887R1 | |
| 3.00 | 25/6453-22 | 3146696R1 | |
| 3.05 | 25/6453-23 | 3147886R1 | |
| 3.10 | 25/6453-24 | 3146695R1 | |
| 3.15 | 25/6453-25 | 3147885R1 | |
| 3.20 | 25/6453-26 | 3146694R1 | |
| 3.30 | 25/6453-27 | 3147884R1 | |

Les références de pièces sont indicatives.
Nos pièces ne sont pas d'origines

Parts numbers are quoted for reference purposes only.
Our parts and accessories are not original



"THE RELIABLE SERVICE"



CASE IH - 4WD - ZF parts

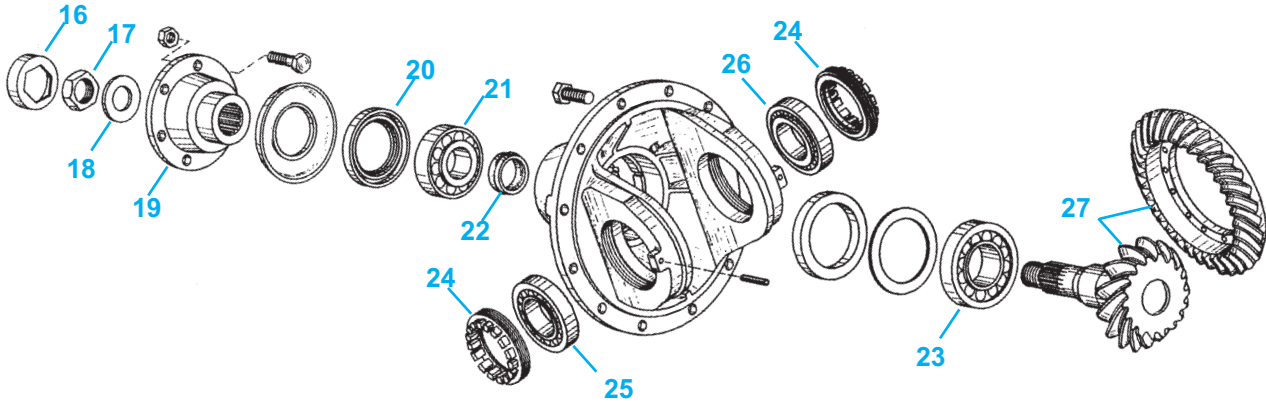

| | | 16 | 17 | 18 | 19 | 20 | 21 |
|---|-------------|--------------------------------|---|---|--|---------------------------------|--|
| Case-IH (Europe) | | | | | | | |
| 533, 633, 733, 833, 933 540, 640, 740, 840, 940 | APL 1251 | | | | 25/345-1 (3216553R1) | | |
| | | | 25/346-2 (934649R1, 3134319R1) | 25/346-7 (3216566R1) | Autobloquant Self lock diff. 25/345-7 (3404786R91) | 25/355-2 (3146754R1) | 25/354-10 (530741R1+ 871241R91) |
| 644, 743, 743XL, 744, 745S, 745XL, 844, 844S, 844XL, 856XL | APL 1351 | | | | 25/345-2 (3230273R1) | | |
| 644, 744, 844, 844S | APL 1551 | 25/346-5 (3147197R1) | 25/346-3 (934262R1) | 25/346-8 (3147196R1) | 25/345-3 (3147225R1) | 25/355-3 (3147195R91) | 25/354-11 (131312C1+ 871244R1) |
| 955, 955XL, 956, 956XL, 1055, 1055XL, 1056, 1056XL | APL 1552 | | | | | | |
| 644, 743, 743XL, 744, 745S, 745XL, 844, 844S 844XL, 856XL, 955, 955XL, 956, 956XL, 1055, 1055XL, 1056, 1056XL | APL 3052 | 25/346-6 (3146651R1) | 25/346-4 (934208R1, A52070) | 25/346-9 (3146650R1, A52069) | 25/345-4 (3146653R1) | | 25/354-12 (530745R1+ 406535R91) |
| 946, 1046, 1246, 1255, 1255XL | | | | | 25/345-5 (3146731R1) | | |
| 1455, 1455XL | APL 3054 | | | | | | |
| Case-IH (UK) | | | | | | | |
| 258, 268, 278, 485XL, 584, 585, 585XL, 684, 685, 685XL, 784, 785, 785XL, 884, 885, 885XL, 85Hydro | APL 1351 | | 25/346-2 (934649R1, 3134319R1) | 25/346-7 (3216566R1) | | 25/355-2 (3146754R1) | 25/354-10 (530741R1+ 871241R91) |

CASE IH - 4WD - ZF parts

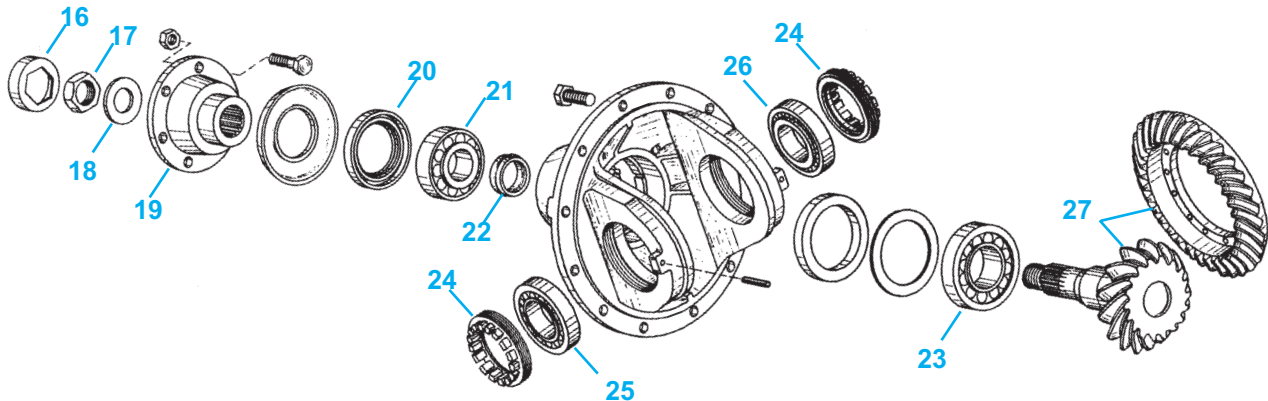

| | | 22 | 23 | 24 | 25 | 26 | 27 |
|---|-------------|--|--|--------------------------------|--|---|---|
| Case-IH (Europe) | | | | | | | |
| 533, 633, 733, 833, 933 540, 640, 740, 840, 940 | APL 1251 | 25/361-1 (3216560R1) | | 25/365-1 (3216565R1) | 25/352-7 (3216713R91, 1964245C1) | | 25/341-11 (3216552R92) |
| 644, 743, 743XL, 744, 745S, 745XL, 844, 844S, 844XL, 856XL | APL 1351 | | | | | | 25/341-12 (3230272R1) |
| 644, 744, 844, 844S | APL 1551 | 25/361-2 (3223198R1) | 25/353-9 (170234R1+ 392679R91) | 25/365-2 (3147194R1) | 25/352-8 (3140666R91) | | 25/341-13 (3223199R1) |
| 955, 955XL, 956, 956XL, 1055, 1055XL, 1056, 1056XL | APL 1552 | | | | | | 25/341-14 (3230314R1) |
| 644, 743, 743XL, 744, 745S, 745XL, 844, 844S 844XL, 856XL, 955, 955XL, 956, 956XL, 1055, 1055XL, 1056, 1056XL | APL 3052 | ⇒ 9269 25/361-3 (3146647R1) 9270 ⇒ 25/361-4 (3223200R1) | 25/353-10 (107577R1+ 298033R91) | 25/365-3 (3134297R1) | 25/352-9 (659459R1+ 659458R91, L33289) | 25/352-10 (105496H+ 105503H) | 25/341-15 (3221720R91) |
| 946, 1046, 1246, 1255, 1255XL | | | | | | | 9270 ⇒ 25/341-17 (3223201R1) |
| 1455, 1455XL | APL 3054 | | | | | | 25/341-18 (3405262R91) |
| Case-IH (UK) | | | | | | | |
| 258, 268, 278, 485XL, 584, 585, 585XL, 684, 685, 685XL, 784, 785, 785XL, 884, 885, 885XL, 85Hydro | APL 1351 | 25/361-1 (3216560R1) | 25/353-8 (197608R1+ 313814R91) | 25/365-1 (3216565R1) | 25/352-7 (3216713R91, 1964245C1) | | 25/341-19 (1502273C91) |

CASE IH - 4WD - ZF parts

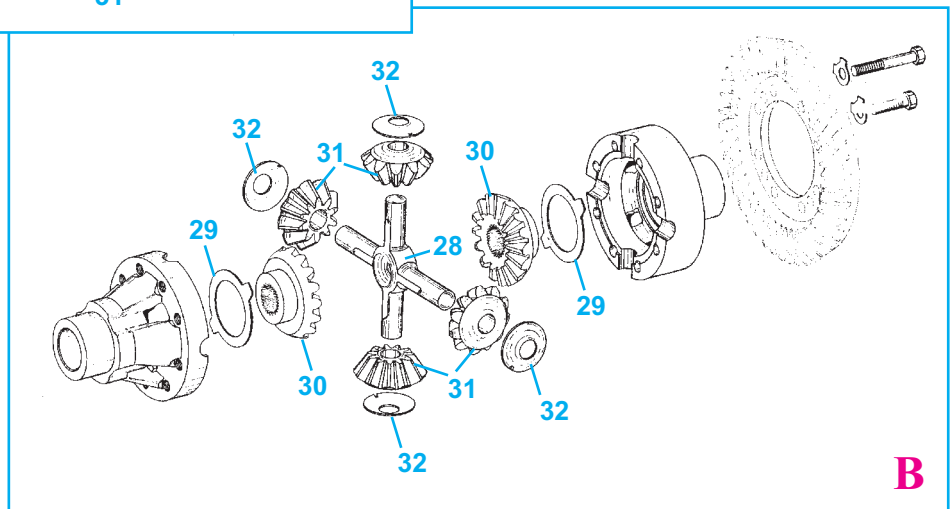
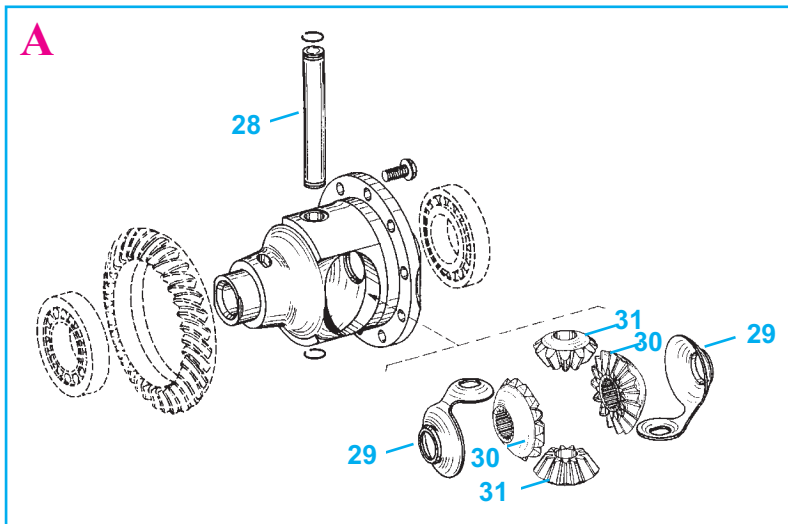

| | | | 28 | 29 | 30 | 31 | 32 |
|---|---|-------------|--|--------------------------------|---------------------------------|--|--------------------------------|
| Case-IH (Europe) | | | | | | | |
| 533, 633, 733, 833, 933, 540, 640, 740, 840, 940 | A | APL 1251 | 25/351-3 (3216569R1) | 25/350-7 (3216572R1) | 25/349-15 (3216570R1) | 25/348-5 (3147201R1, 3230284R1) | |
| 644, 743, 743XL, 744, 745S, 745XL, 844, 844S, 844XL, 856XL | A | APL 1351 | 25/351-4 (3230255R1) | 25/350-4 (3230258R1) | 25/349-9 (3230256R1) | 25/348-4 (3230257R1) | |
| 644, 744, 844, 844S | B | APL 1551 | 25/351-5 (3147202R1) (Shaft) | 25/350-5 (3147203R1) | 25/349-10 (3230292R1) | 25/348-5 (3147201R1, 3230284R1) | 25/347-4 (3147204R1) |
| 955, 955XL, 956, 956XL, 1055, 1055XL, 1056, 1056XL | B | APL 1552 | | | | | |
| 644, 743, 743XL, 744, 745S, 745XL, 844, 844S, 844XL, 856XL, 946, 955, 955XL, 956, 956XL, 1046, 1055, 1055XL, 1056, 1056XL, 1246, 1255, 1255XL | B | APL 3052 | 25/351-6 (3146660R1) (Crucifix) | 25/350-6 (3146661R1) | 25/349-11 (3221075R1) | 25/348-6 (3134290R1) | 25/347-5 (3146662R1) |
| 1455, 1455XL | B | APL 3054 | | | | | |
| Case-IH (UK) | | | | | | | |
| 258, 268, 278, 485XL, 584, 585, 585XL, 684, 685, 685XL, 784, 785, 785XL, 884, 885, 885XL, 85Hydro | A | APL 1351 | 25/351-4 (3230255R1) | 25/350-4 (3230258R1) | 25/349-9 (3230256R1) | 25/348-4 (3230257R1) | |

CASE IH - 4WD - ZF parts

A

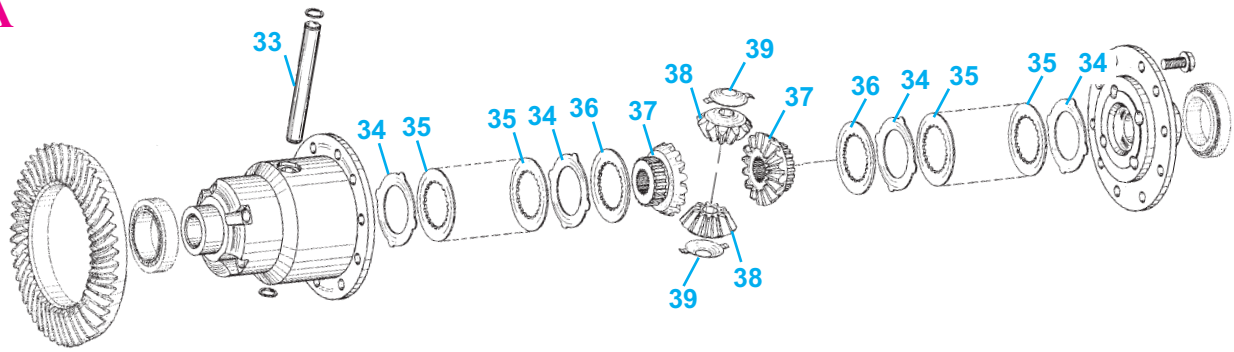

B

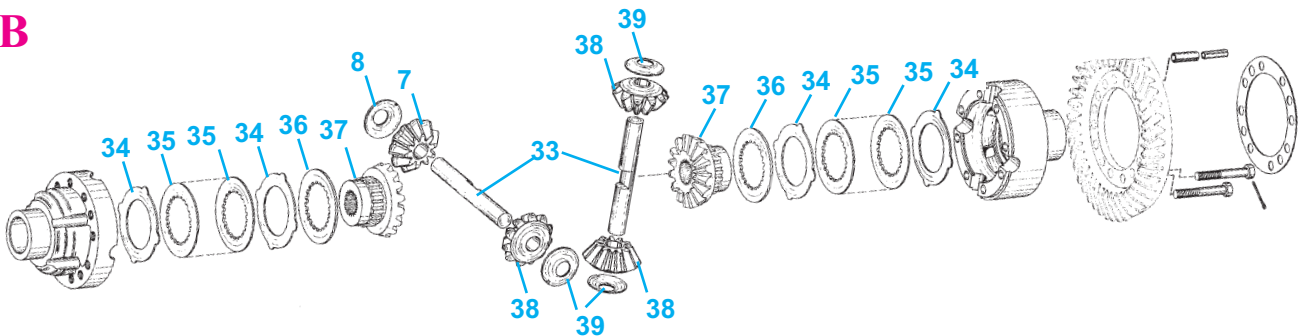

| | | 33 | 34 | 35 | 36 | 37 | 38 | 39 |
|---|-------------------------|--------------------------------|---------------------------------|---------------------------------|---|---------------------------------|--------------------------------|--------------------------------|
| Case-IH (Europe) | | | | | | | | |
| 533, 633, 733, 833, 933, 540, 640, 740, 840, 940 | APL 1251 A | 25/351-3 (3216569R1) | | | 2,8mm 25/350-8 (3223463R1) | 25/349-12 (3230283R1) | | |
| 644, 743, 743XL, 744, 745S, 745XL, 844, 844S, 844XL, 856XL | APL 1351 A | | | | 2,9mm 25/350-9 (3223462R1) | | | |
| 644, 744, 844, 844S | APL 1551 B | 25/351-5 (3147202R1) | 25/316-20 (3223459R1) | 25/317-19 (3223460R1) | 3,0mm 25/350-10 (3223461R1) | 25/349-13 (3230320R1) | 25/348-5 (3230284R1) | 25/347-4 (3147204R1) |
| 955, 955XL, 956, 956XL, 1055, 1055XL, 1056, 1056XL | APL 1552 B | | | | | | | |
| 644, 743, 743XL, 744, 745S, 745XL, 844, 844S, 844XL, 856XL, 946, 955, 955XL, 956, 956XL, 1046, 1055, 1055XL, 1056, 1056XL, 1246, 1255, 1255XL | APL 3052 B | 25/351-7 (3216750R1) | 25/316-21 (3216742R1) | 25/317-20 (3216743R1) | 2,9mm 25/350-12 (3216745R1) | 25/349-14 (3216747R1) | 25/348-7 (3216748R1) | 25/347-6 (3216749R1) |
| 1455, 1455XL | APL 3054 B | | | | | | | |
| Case-IH (UK) | | | | | | | | |
| 258, 268, 278, 485XL, 584, 585, 585XL, 684, 685, 685XL, 784, 785, 785XL, 884, 885, 885XL, 85Hydro | APL 1351 A | 25/351-3 (3216569R1) | 25/316-20 (3223459R1) | 25/317-19 (3223460R1) | 2,8mm 25/350-8 (3223463R1) | 25/349-12 (3230283R1) | 25/348-5 (3230284R1) | 25/347-4 (3147204R1) |
| | | | | | 2,9mm 25/350-9 (3223462R1) | | | |
| | | | | | 3,0mm 25/350-10 (3223461R1) | | | |

CASE IH - 4WD - ZF parts

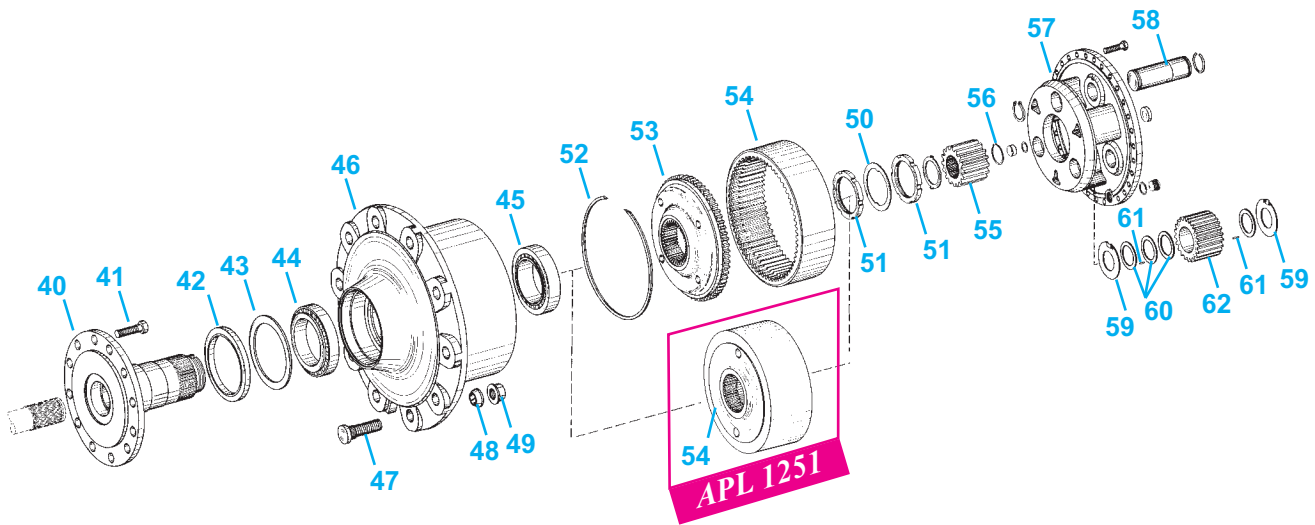

| | | 40 | 41 | 42 | 43 | 44 | 45 |
|---|-------------|--|--|-----------------------------------|---------------------------------|--|---|
| Case-IH (Europe) | | | | | | | |
| 533, 633, 733, 833, 933 540, 640, 740, 840, 940 | APL 1251 | 25/6415-1 (3216590R2, 3226042R91) | 25/440-25 (934654R1, 628-12025) | 25/6408-25 (3216594R1) | 25/6417-2 (3216593R1) | 25/6410-21 (625743C1+ 3216619R91) | 25/6410-25 (3216620R2+ 3143564R92) |
| 644, 743, 743XL, 744, 745S, 745XL, 844, 844S, 844XL, 856XL | APL 1351 | 25/6415-2 (3232082R91) | | | | 25/6410-29 (625743C1+ A61447) | 25/6410-26 (A75210+ A75211) |
| 644, 744, 844, 844S | APL 1551 | 25/6415-3 (3230890R91) | 25/440-26 (931640R1, 614-14040) | 25/6408-26 (3147259R91) | 25/6417-3 (3147263R1) | 25/6410-22 (A26744+ ST2001A) | 25/6410-27 (3232808R91) |
| 955, 955XL, 956, 956XL, 1055, 1055XL, 1056, 1056XL | APL 1552 | 25/6415-4 (3232083R91) | | | | 25/6410-30 (G15208+ ST2039) | 25/6410-31 (3230311R92) |
| 644, 743, 743XL, 744, 745S, 745XL, 844, 844S 844XL, 856XL, 946, 955, 955XL, 956, 956XL, 1046, 1055, 1055XL, 1056, 1056XL, 1246, 1255, 1255XL | APL 3052 | 25/6415-5 (3230889R91) | 25/440-27 (931218R1, 613-16030) | 25/6408-27 (3146686R91) | | 25/6410-23 (529453R1+ 529452R1) | 25/6410-22 (A26744+ ST2001A) |
| 1455, 1455XL | APL 3054 | 25/6415-6 (3405253R91) | 25/440-29 (31140R1, 626-16030) | 25/6408-28 (3405258R1) | 25/6417-4 (3405259R1) | 25/6410-24 (ST990+ ST2133) | |
| | | | 25/440-30 (31141R1) | | | | |
| Case-IH (UK) | | | | | | | |
| 258, 268, 278, 485XL, 584, 585, 585XL, 684, 685, 685XL, 784, 785, 785XL, 884, 885, 885XL, 85Hydro | APL 1351 | 25/6415-2 (1502272C1, 3232082R91) | 25/440-25 (934654R1, 628-12025) | 25/6408-25 (3216594R1) | 25/6417-2 (3216593R1) | | 25/6410-26 (A75210+ A75211) |

CASE IH - 4WD - ZF parts

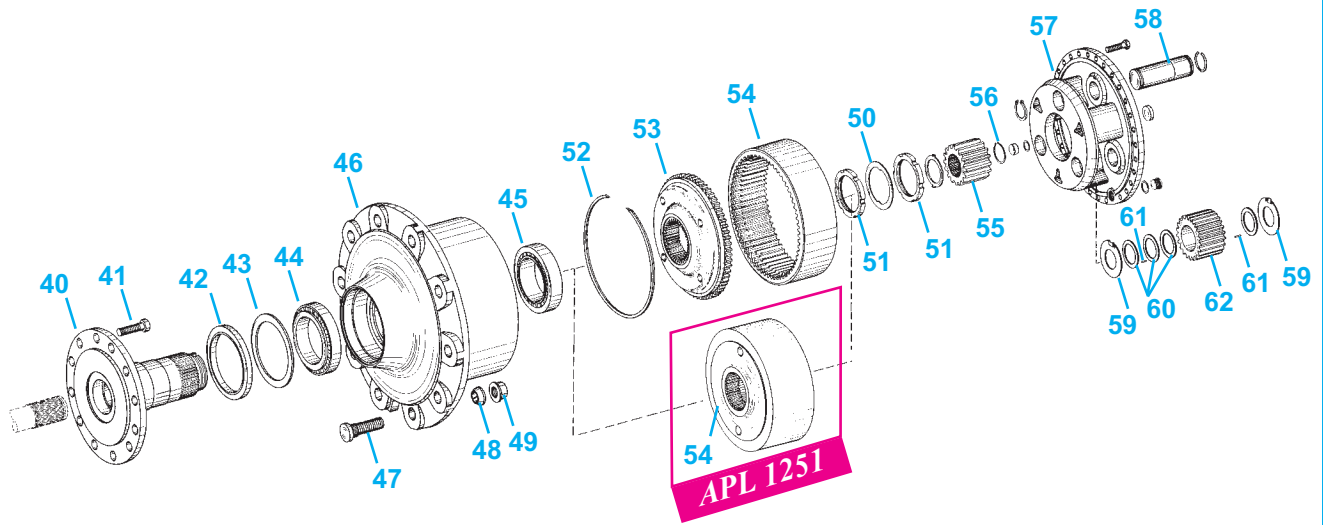

| | | 46 | 47 | 48 | 49 | 50 | 51 |
|---|-------------|--------------------------------|---------------------------------|---------------------------------|---|---------------------------------|---------------------------------|
| Case-IH (Europe) | | | | | | | |
| 533, 633, 733, 833, 933 540, 640, 740, 840, 940 | APL 1251 | 25/445-1 (3216598R1) | 25/440-23 (3230876R1) | 25/441-9 (3230348R3) | 25/441--23 (3230877R1, 905667R1) | 25/451-7 (3216591R1) | 25/452-18 (934655R1) |
| 644, 743, 743XL, 744, 745S, 745XL, 844, 844S, 844XL, 856XL | APL 1351 | 25/445-2 (3230280R1) | | | | 25/451-8 (3230270R1) | 25/452-11 (3230269R1) |
| 644, 744, 844, 844S | APL 1551 | 25/445-3 (3147261R1) | | | | 25/451-9 (3147253R1) | 25/452-12 (3147252R1) |
| 955, 955XL, 956, 956XL, 1055, 1055XL, 1056, 1056XL | APL 1552 | 25/445-4 (3230313R1) | | | | 25/451-10 (3230310R1) | 25/452-13 (934013R1) |
| 644, 743, 743XL, 744, 745S, 745XL, 844, 844S 844XL, 856XL, 946, 955, 955XL, 956, 956XL, 1046, 1055, 1055XL, 1056, 1056XL, 1246, 1255, 1255XL | APL 3052 | 25/445-5 (3146688R1) | 25/440-24 (3230878R1) | | | | 25/452-14 (3229142R1) |
| 1455, 1455XL | APL 3054 | 25/445-6 (3405257R1) | 25/440-31 (3405268R1) | 25/441-11 (3230875R2) | 25/441--24 (905654R1, 1541701C1) | 25/451-11 (3405256R1) | 25/452-15 (905653R1) |
| Case-IH (UK) | | | | | | | |
| 258, 268, 278, 485XL, 584, 585, 585XL, 684, 685, 685XL, 784, 785, 785XL, 884, 885, 885XL, 85Hydro | APL 1351 | 25/445-2 (3230280R1) | 25/440-23 (3230876R1) | 25/441-9 (3230348R3) | 25/441--23 (3230877R1, 905667R1) | 25/451-8 (3230270R1) | 25/452-11 (3230269R1) |

CASE IH - 4WD - ZF parts

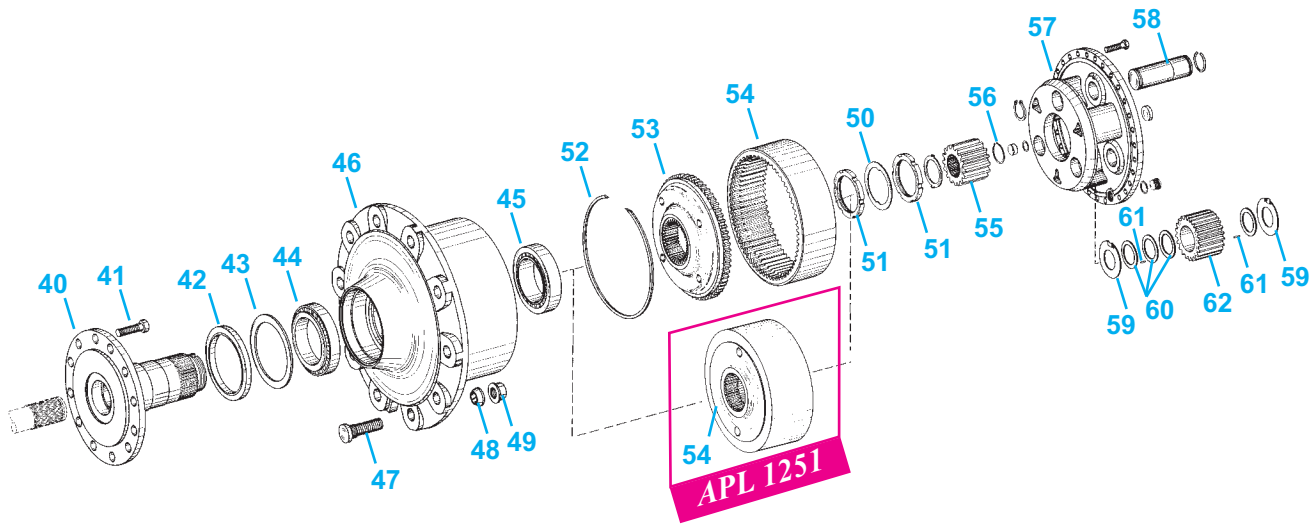

| | | 52 | 53 | 54 | 55 | 56 |
|--|-------------|---------------------------------|---------------------------------|----------------------------------|----------------------------------|--|
| Case-IH (Europe) | | | | | | |
| 533, 633, 733, 833, 933 540, 640, 740, 840, 940 | APL 1251 | | | 25/6430-11 (3216583R1) | 25/6406-10 (3216582R1) | |
| 644, 743, 743XL, 744, 745S, 745XL, 844, 844S, 844XL, 856XL | APL 1351 | 25/6436-1 (3146675R1) | 25/6435-1 (3230266R1) | 25/6430-12 (3230267R1) | 25/6406-11 (3230265R1) | 25/6434-14 (933074R1, 800-1128) |
| 644, 744, 844, 844S | APL 1551 | | 25/6435-2 (3147214R1) | 25/6430-13 (3147215R1) | 25/6406-12 (3147213R1) | 25/6434-15 (933029R1, 800-1135) |
| 955, 955XL, 956, 956XL, 1055, 1055XL, 1056, 1056XL | APL 1552 | | 25/6435-3 (3230299R1) | 25/6430-14 (3230300R1) | 25/6406-13 (3230298R1) | 25/6434-16 (3134245R1) |
| 644, 743, 743XL, 744, 745S, 745XL, 844, 844S, 844XL, 856XL, 946, 955, 955XL, 956, 956XL, 1046, 1055, 1055XL, 1056, 1056XL, 1246 1255, 1255XL (⇒ 46436) | APL 3052 | | 25/6435-4 (3146673R2) | 25/6430-16 (3146674R1) | 25/6406-14 (3146672R1) | 25/6434-17 (933804R1) |
| 1255, 1255XL (46436 ⇒) | | | | 25/6430-15 (112245A1) | 25/6406-15 (112244A1) | |
| 1455, 1455XL | APL 3054 | | 25/6436-2 (3405359R1) | 25/6435-5 (3405357R1) | 25/6430-17 (3405358R1) | 25/6406-16 (3405356R1) |
| Case-IH (UK) | | | | | | |
| 258, 268, 278, 485XL, 584, 585, 585XL, 684, 685, 685XL, 784, 785, 785XL, 884, 885, 885XL, 85Hydro | APL 1351 | 25/6436-1 (3146675R1) | 25/6435-1 (3230266R1) | 25/6430-12 (3230267R1) | 25/6406-11 (3230265R1) | 25/6434-14 (933074R1, 800-1128) |

CASE IH - 4WD - ZF parts

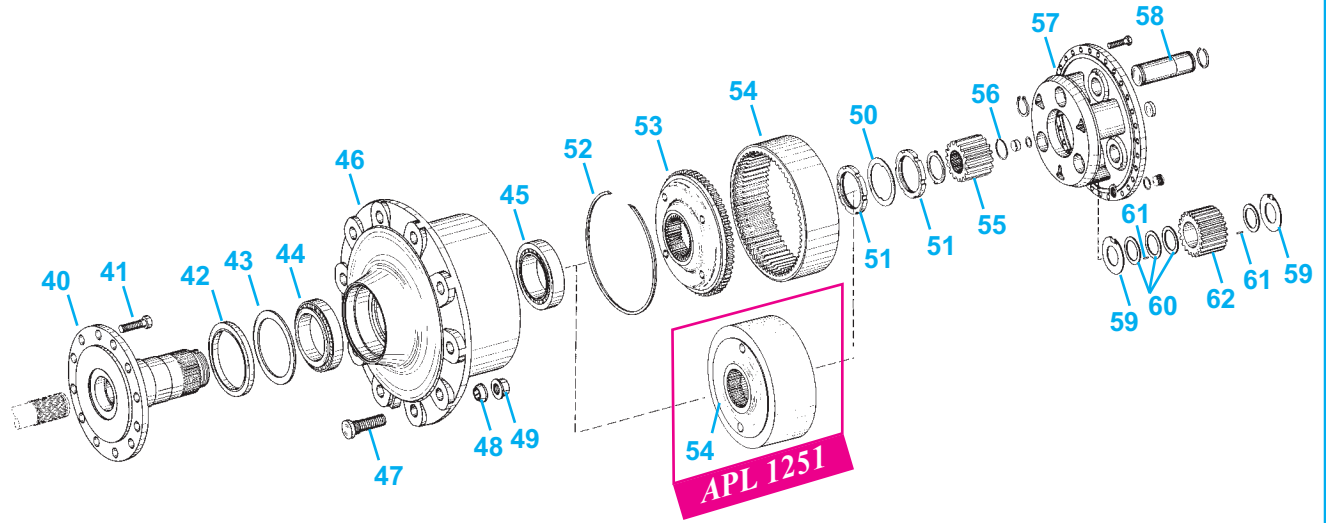

| | | 57 | 58 | 59 | 60 | 61 | 62 |
|---|-------------|--|---------------------------------|--------------------------------|--------------------------------|----------------------------------|----------------------------------|
| Case-IH (Europe) | | | | | | | |
| 533, 633, 733, 833, 933 540, 640, 740, 840, 940 | APL 1251 | 25/6401-9 (3401535R1) | 25/381-11 (3216574R1) | 25/384-8 (3216577R1) | 25/384-5 (3216576R1) | 25/6433-6 (934642R1) | 25/6431-9 (3216575R1) |
| 644, 743, 743XL, 744, 745S, 745XL, 844, 844S, 844XL, 856XL | APL 1351 | 25/6401-10 (3230259R1) | 25/381-12 (3230260R1) | | | 25/6433-7 (3230262R1) | 25/6431-10 (3230261R1) |
| 644, 744, 844, 844S | APL 1551 | 25/6401-11 (3147205R1, 3234426R1) | 25/381-13 (3147206R1) | | | 25/6433-8 (3147208R1) | 25/6431-11 (3147207R1) |
| 955, 955XL, 956, 956XL, 1055, 1055XL, 1056, 1056XL | APL 1552 | 25/6401-12 (3230293R1) | 25/381-7 (3230294R1) | 25/384-3 (3146668R1) | 25/384-6 (3146667R1) | | 25/6431-12 (3230295R1) |
| 644, 743, 743XL, 744, 745S, 745XL, 844, 844S 844XL, 856XL, 946, 955, 955XL, 956, 956XL, 1046, 1055, 1055XL, 1056, 1056XL, 1246 1255, 1255XL (⇒ 46436) | APL 3052 | | 25/381-8 (3146664R1) | | | 25/6433-9 (3146666R2) | 25/6431-13 (3146665R1) |
| 1255, 1255XL (46436 ⇒) | | | 25/381-9 (112242A1) | | | | 25/6431-14 (112243A1) |
| 1455, 1455XL | APL 3054 | | 25/381-10 (3405261R1) | 25/384-4 (3405354R1) | 25/384-7 (3405353R1) | 25/6433-10 (3405352R1) | 25/6431-15 (3405351R1) |
| Case-IH (UK) | | | | | | | |
| 258, 268, 278, 485XL, 584, 585, 585XL, 684, 685, 685XL, 784, 785, 785XL, 884, 885, 885XL, 85Hydro | APL 1351 | 25/6401-10 (3230259R1) | 25/381-12 (3230260R1) | 25/384-3 (3146668R1) | 25/384-6 (3146667R1) | 25/6433-7 (3230262R1) | 25/6431-10 (3230261R1) |



CASE IH (SUPPLEMENT)



| Tracteurs Tractors | 1 | | 2 | 3 | 4 |
|--|---|---------------------------------|--|--|---|
| | Air | | Huile Oil | Combustible Fuel | Hydraulique Hydraulic |
| | Ext. / Out. | Int. / Inn. | | | |
| CS68, 68A Moteur WD 301.89 Engine CS75, 75A Moteur WD 301.88 Engine | 60/161-19 (3146576R1) | 60/162-19 (3147878R1) | 60/97-11 (3055134R91, 3055229R91, 3132023R92, 3136459R93) | 60/111-16 (3132275R1, 3132428R2, 313248R1, 3136187R91, 3218794R91, J931062) | 60/240-63 |
| CS78 Moteur WD 401.81 Engine CS86 Moteur WD 401.83 Engine CS94 Moteur WD 401.85 Engine | 60/161-35 (3146939R1) | 60/162-20 (3216100R1) | 60/97-2 (895293R91, 918266R91, A58758, K955687) | | |
| CS110 Moteur 420.80 Engine CS120 Moteur 620.84 Engine CS130 Moteur 620.82 Engine CS150 Moteur 620.83 Engine | 60/161-31 (3219420R1, 3226416R1) | 60/162-31 (3219421R1) | 60/97-33 (62000070744) | 60/111-4 (162000081001) | 60/240-52 (131775810) (Cartouche Cartridge Boîte de vitesses Gearbox) |
| CX50, CX60 | | | 60/97-2 (895293R91, 918266R91, A58758, K955687) | 60/111-3 (1502155C91, 3044506R91, 3062788R91, 3069205R91, 306975R91, 3138428R91, 3144306R91, 765951R91, 795872R91, 796051R91, K906708, K960911) (Repl. CAV296) | |



CASE IH (SUPPLEMENT)

| Tracteurs Tractors | 1 | | 2 | 3 | 4 |
|--|---------------------------------|---------------------------------|--|---|--|
| | Air | | Huile Oil | Combustible Fuel | Hydraulique Hydraulic |
| | Ext. / Out. | Int. / Inn. | | | |
| CX70, CX80, CX90, CX100, C70, C80, C90, C100 | 60/161-92 (222421A1) | 60/162-92 (222422A1) | 60/97-2 (895293R91, 918266R91, A58758, K955687) | 60/111-16 (3132275R1, 3132428R2, 313248R1, 3136187R91, 3218794R91, J931062) ou / or 60/111-3 (1502155C91, 3044506R91, 3062788R91, 3069205R91, 306975R91, 3138428R91, 3144306R91, 765951R91, 795872R91, 796051R91, K906708, K960911) (Repl. CAV296) | 60/240-42 (133736C1, 401073R2, 530144C91, 0530144R92, 93413C1) |
| MAXXUM MX100, MX110, MX120, MX135 MX150, MX170 | 60/161-164 (187471A1) | 60/162-164 (187472A1) | 60/97-51 (1240388H1, J903264, J908615) | 60/111-25 (3132428R1, 3218793R91) | 60/240-70 (1976934C3, 1976934C5) |
| MAGNUM MX180, MX200, MX220, MX240, MX270 | | | 60/97-74 (J919562) Filet / Thread 2 1/4" | 60/111-44 (A41745, A77470, J903410, J925274) Filet / Thread 1 3/16 (Primaire / Primary) 60/111-56 (161624, J903640) Filet / Thread M16 (Secondaire Secondary) | 60/641-16 (1971728C1, 277311A1) |

Filtre de cabine Cab filter

60/4200-17
(134584216)

243,5 x 173 x 50 mm

Pour / For : CS110, CS120, CS130, CS150



Les références de pièces sont indicatives.
Nos pièces ne sont pas d'origines

Parts numbers are quoted for reference purposes only.
Our parts and accessories are not original



TRACPIECES

bepco tractor parts

PRODUCT NEWS-SHEET

PAGE : N°7117
DATE : 07/2001

CASE-IH (David Brown) PARTS

Pompes à eau
Water pumps
Wasserpumpen
Waterpompen
Bombas de agua



1



2



3



4



5



6



7

|  | Fig. | PART N° | OEM |
|---|------|------------|--|
| 1594, 1690 (11210101⇒11214370), 1690T, 1694 | 1 | 20/130-180 | K200759 |
| 885, 990 (866384⇒), 995 (943287⇒) 996 (987778⇒), 1210 (729733⇒), 1212 (1004296⇒), 1410, 1412 | 2 | 20/130-181 | K262749 K952127 K915842 |
| 780 (A) 880 (530001⇒563379), 885 885, 885N (11000001⇒), 885G, 990, 996, 1210, 1212 | 3 | 20/130-182 | K952713 K925067 K949547 K262898 |
| 1190, 1190E, 1194 | 4 | 20/130-183 | K200807 K203618 |
| 1494, 1490 | 5 | 20/130-184 | K207578 |
| 770, 780 (B), 880 | 6 | 20/130-185 | K911964 |
| 1290, 1294, 1390, 1394 | 7 | 20/130-187 | K201750 |

- (A) Avec sortie pour durite by-pass droite
- (B) Avec sortie pour durite by-pass en accordéon
- (A) With outlet for right hand by-pass hose
- (B) With outlet for flexible by-pass hose
- (A) Mit Ausgang (für rechtsseitigen) "By-pass" Schlauch
- (B) Mit Ausgang (für flexibelen) "By-pass" Schlauch

- (A) Met plat rubber tussen kop en waterpomp
- (B) Met bolle slang tussen kop en waterpomp
- (A) Con salida para manguito by-pass derecha
- (B) Con salida para manguito by-pass en acordeón

Accouplement de pompe hydraulique
Hydraulic pump coupling
Kupplung für hydraulik-pump
Koppelingsbus hydrauliekpomp
Acoplamiento bomba hidráulica



LG.: 63mm

|  | PART N° | OEM |
|--|----------|---------|
| 885, 990, 995, 996, 1200SEL, 1210, 1212 | 20/663-4 | K917058 |

Les références des pièces sont indicatives.
Nos pièces ne sont pas d'origine.

Part numbers are quoted for reference purposes only.
Our parts and accessories are not original.



"THE RELIABLE SERVICE"





TRACPIECES

bepco tractor parts

**PRODUCT
NEWS-SHEET**

PAGE : N°7124
DATE : 08/2001

CASE-IH PARTS

**COUDE D'ÉCHAPPEMENT - EXHAUST ELBOW - AUSPUFFKRÜMMER -
UITLAATBOCHT - CODOS DE ESCAPE**

955 (+XL), 1055 (+XL), 956 (+XL), 1056 (+XL)



25/164-34
(3220368R1)



743 (+XL), 745S, 844S, 845 (+XL), 745XL, 844XL



25/164-35
(3402326R2)



433, 533, 633, 733, 833, 933 (+V&E)



25/164-36
(3399348R1)



644, 744, 844, 844S



25/164-37
(3145625R2)

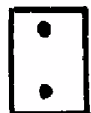

Les références des pièces sont indicatives.
Nos pièces ne sont pas d'origine.

Part numbers are quoted for reference purposes only.
Our parts and accessories are not original.



"THE RELIABLE SERVICE"





TRACPIECES

bepco tractor parts

PRODUCT NEWS-SHEET

PAGE : N°7123
DATE : 08/2001

CASE-IH PARTS

FREINAGES - BRAKES - BREMSSEN - REMMEN - FRENOS

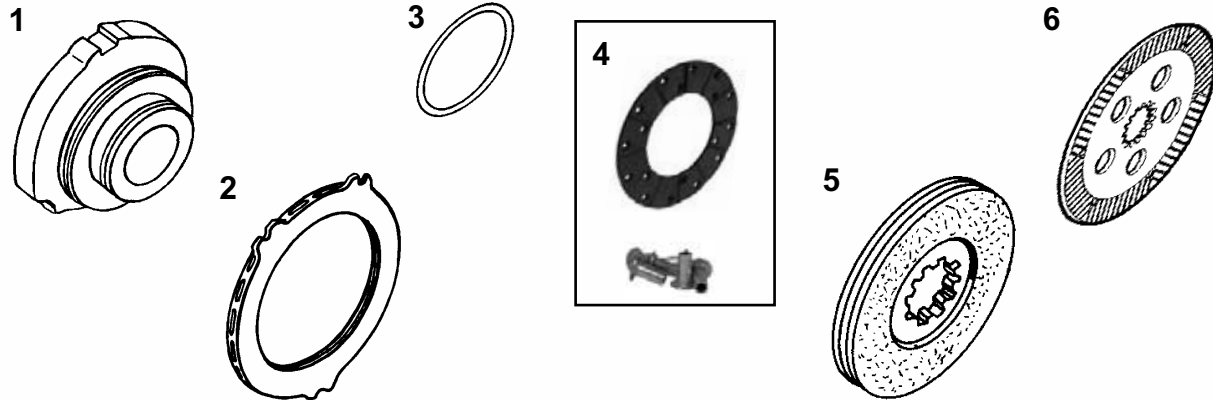

|  | Fig. | PART N° | OEM | |
|---|------|---|---------------------|--|
| 743, 743XL, 745XL, 745S, 844S, 844XL, 845, 845XL, 856XL | 1 | 25/417-24 | 3223252R7 | Piston de frein - Brake piston - Bremskolben - Remzuiger - Pistón de freno |
| | 2 | 25/423-8 | 3145548R2 | Disque intermédiaire - Intermediate disc - Zwischenscheibe - Tussenplaat remmen-Plancha de freno |
| 238, 248, 258, 268, 278, 288, 385, 484, 485, 495XL, 585, 595XL, 695, 695XL, 784, 785, 795, 795XL, 895, 995XL, 3210, 3220, 3230, 4210, 4220, 4230, 4240, C50, C60, C80, C90, C100, CX50, CX60, CX70, CX80, CX90, CX100 | 3 | 25/416-8 | 238-6267 21472R1 | "O" Ring - "O" Ring - "O" Ring - "O" Ring - Junta tórica |
| 3210, 3220, 3230, 4210, 4220, 4230, 4240, C50, C60, C70, C80, C90, C100, CX50, CX60, CX70, CX80, CX90, CX100 | | 25/416-9 | 238-5367 | |
| 743, 743XL, 745S, 745XL, 844S, 844XL, 845, 845XL, 856XL, 955, 955XL, 956, 956XL, 1055, 1055XL, 1056, 1056XL | | 25/416-10 | 3230853R1 | |
| | | 25/416-11 | 3230854R1 | |
| 135, 137, 240 | 4 | 25/421-21 Ø127mm | | Garniture de frein (4) - 4 Brake linings - Satz Beläge (4) - Remvoeringsset (4) - Juego de zapata(4) |
| 523, 553, 624, 654, 724, 824 | 5 | 25/420-13 Ø176mm 56,5x48mm | 3134665R92 | Disque de frein - Brake discs - Bremsscheibe - Remschijf-droog - Disco de freno |
| 553, 554, 644, 654, 724, 743, 743XL, 745S, 745XL, 824, 844S, 844XL, 845, 845XL | | 25/420-14 Ø200mm 56,5x48mm | 131787A1 | |
| 5120, 5130, 5140, 5150, MX100, MX110, MX120, MX135, MX80C, MX90C, MX100C | 6 | 25/420-20 | A190067 | |

Les références des pièces sont indicatives.
Nos pièces ne sont pas d'origine.

Part numbers are quoted for reference purposes only.
Our parts and accessories are not original.



"THE RELIABLE SERVICE"



CASE-IH PARTS

CYLINDRES DE FREINAGE - BRAKE CYLINDERS - BREMSEN ZYLINDER - REMSCILINDER - CILINDROS DE FRENO

6

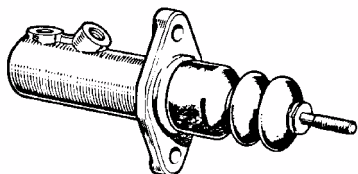

7

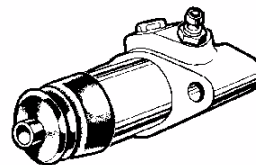

|  | Fig. | PART N° | OEM | |
|---|------|-----------|------------|---|
| 956, 956XL, 1056, 1056XL | 6 | 25/410-9 | 3402462R91 | Maitre cylindre de frein Master brake cylinder Hauptbremszylinder |
| 946, 1046, 1246 | | 25/410-8 | 3141682R92 | Hoofdcilinder (remmen) Cilindro principal (freno) |
| 946, 1046, 1246 | 7 | 25/413-9 | 3141932R91 | Cylindre recepteur de frein Slave brake cylinder Nehmerzylinder |
| 1255XL, 1455XL | | 25/413-11 | 3401367R1 | Wielremcilinder Cilindro receptor (freno) |

Les références des pièces sont indicatives.
Nos pièces ne sont pas d'origine.

Part numbers are quoted for reference purposes only.
Our parts and accessories are not original.



TRACPIECES

bepco tractor parts

PRODUCT NEWS-SHEET

PAGE : N°7121
DATE : 08/2001

CASE-IH PARTS

**TRANSMISSION AVANT - FRONT TRANSMISSION - SPURSTANGE+AXIALGELENKE -
TRANSMISSIE VOORAANDRIJVING - TRANSMISIÓN DELANTERA**

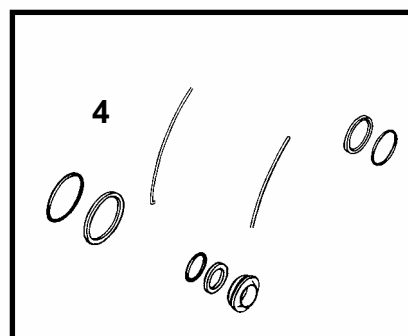

|  | Fig. | PART N° | OEM | |
|---|------|---------------------------|--------------|---|
| 353, 423 | 1 | 25/490-22 | 3058842R94 | Barre de direction Steering link Spurstange Spoorstang Barras de dirección |
| MX80C, MX90C, MX100C, MX100, MX110, MX120, MX135, MAXXUM 5120, 5130, 5140, 5150 | 2 | 25/497-17 | N14377 | Accouplement de direction Steering coupling Axialgelenk Scharniergewricht Acople de dirección |
| CS110, CS120, CS130, CS150, CVX120, CVX130, CVX150, CVX170 | | 25/497-141 | 1-33-743-613 | |
| CS42, CS48A | | 25/497-142 | 135700431012 | |
| MAXXUM 5120, 5130, 5140, 5150 | 3 | 25/2310-24LH M24x1,5LH | 126141A1 | Ecrou Nut Mutter Borgmoer Tuerca |
| MAXXUM 5120, 5130, 5140, 5150, MX80C, MX90C, MX100C, MX100, MX110, MX120, MX135, MX150, MX170, CS110, CS120, CS130, CS140, CS150 | | 25/2310-24RH M24x1,5RH | 126143A1 | |
| 238, 248, 258, 268, 278, 288, 385, 395, 454, 484, 485, 485XL, 495, 495XL, 574, 584, 585, 585XL, 595, 595XL, 684, 685, 685XL, 695, 695XL, 784, 785, 785XL, 795, 795XI, 884, 885, 885XL, 895, 895XL, 995XL, 2500, 3210, 3220, 3230, 4210, 4220, 4230, 4240, 85HYD | 4 | 25/585-7 | 55355C91 | Kit de joints de direc. assistée Power steering seal kit Dichtungssatz für Lenkhilfe Rep. Set. stuurcilinder (2WD) Juego juntas dirección assistida |

Les références des pièces sont indicatives.
Nos pièces ne sont pas d'origine.

Part numbers are quoted for reference purposes only.
Our parts and accessories are not original.





"THE RELIABLE SERVICE"

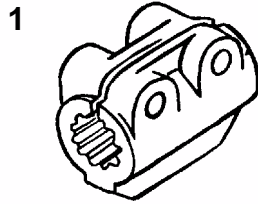

CASE-IH PARTS

TRANSMISSION AVANT - FRONT TRANSMISSION - ANTRIEB VORBAU - TRANSMISSIE VOORAANDRIJVING - TRANSMISIÓN DELANTERA



|  | Fig. | PART N° | OEM | |
|--|------|--------------------------------|---------|--|
| 238, 258, 268, 288, 395, 495, 495XL, 595, 595XL, 695, 695XL, 795, 795XL, 895, 895XL, 995XL (carraro with ZF transfer gearbox) 258, 685, 685XL, 743, 745S, 785, 785XL, 844S, 845, 856XL, 885, 885XL (APL335) 956, 956XL, 1056, 1056XL | 1 | 25/6447-6 | 90030C2 | Manchon d'entr. d'arbre de transm. avant (4WD) Front drive shaft bush (4WD) Buchse für Antriebswelle (4WD) Voorwielaandrijving koppelstuk (4WD) Casquillo estriado del eje delantero (4WD) |
| 238, 248, 258, 268, 288, 395, 495, 495XL, 595, 595XL, 695, 695XL, 795, 795XL, 895, 895XL, 995XL (ZFwith ZF transfer gearbox) 485, 585, 685, 685XL, 743, 745S, 785, 785XL, 844S, 845, 856XL, 885, 885XL (APL330) | | 25/6447-7 | 90031C2 | |
| 238, 248, 258, 268, 288, 395, 485, 495, 495XL, 585, 595XL, 685, 685XL, 695, 695XL, 743, 743XL, 745S, 745XL, 785, 785XL, 795, 795XL, 844S, 844XL, 845, 845XL, 856XL, 885, 885XL, 895, 895XL, 956, 956XL, 995XL, 1056, 1056XL 485XL, 585XL (->734/APL330) | 2 | 25/6448-1 M12x45 | 90088C1 | Vis Screw Schraube Bout Tornillo |

HYDRAULIQUE - HYDRAULIC - HYDRAULIEK - HYDRAULIK - HIDRAULICA

DISTRIBUTEUR - SPOOL - VERTEILER - HYDR.VERDEELBLOK - TUBERIA

743XL, 745, 844, 844S, 846, 856,
946, 955XL, 1046, 1055XL, 1056,
1246, 1255, 1455



25/7600-21

(Repl. :0521705509, 0521705519,
0521705521, 0521705035,
0521705038)

220 Bar,
70l/min Max.

COUPLEUR - COUPLING - KUPPLUNG - HYDR.SNELKOPPELING - ACOPLAMIENTO

CS / CVX

25/908-6
(155700730350, 132373037)



VALVE - VALVE - VENTIL - MOEDERBLOK - VALVULA

|  | Fig. | PART N° |
|---|------|--|
| 946, 1046, 1246 | 1 | 25/7611-1 (3147440R91, 3140895R92) |
| 1255, 1255XL, 1455, 1455XL | 2 | 25/7611-5 (89845C91) |

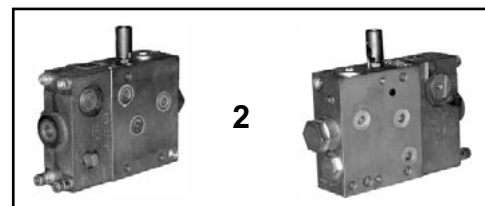
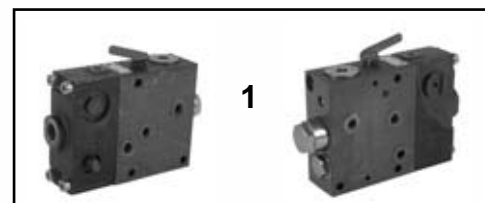

Les références des pièces sont indicatives.
Nos pièces ne sont pas d'origine.

Part numbers are quoted for reference purposes only.
Our parts and accessories are not original.



TRACPIECES

bepco tractor parts

PRODUCT NEWS-SHEET

PAGE : N°7119
DATE : 08/2001

CASE-IH PARTS

STABILISATEURS & COMPOSANTS - STABILISERS & COMPONENTS - STABILISATOREN & EINZELTEILE - STABILISATOREN & ONDERDELEN - ESTABILIZADORES Y COMPONENTES

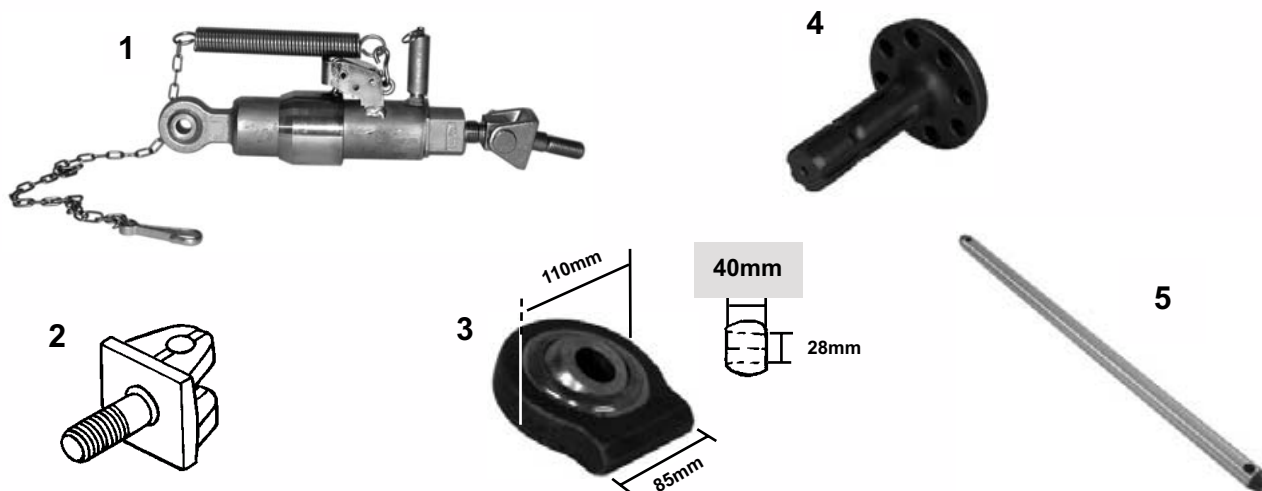

|  | Fig. | PART N° | OEM | |
|---|------|--------------------------------------|---------------------|--|
| MAXXUM 5110, 5120, 5130, 5140, MX80C, MX90C, MX100C, MX110, MX120, MX135 | 1 | 25/740-32 | 253697A 193137A2 | Stabilisateur adaptable automatique Automatic adaptable stabiliser Automatischer Stabilisator Automatisch geregelode stabilisator Estabilizador adaptable automático |
| MAXXUM 5110, 5120, 5130, 5140, MX80C, MX90C, MX100C, MX110, MX120, MX135 | 2 | 25/746-12 M24 | 193149A1 | Fourche Yoke Gabel Gaffel Horquilla |
| 955, 955XL, 956, 956XL, 1055, 1055XL, 1056, 1056XL | 3 | 25/715-11 | | Rotule à souder weld-on-end Anschweisskugel Aanlaskogel Rótula para soldar |
| CS110, CS120, CS130, CS150, CVX120, CVX130, CVX150, CVX170 (ZF) | 4 | 25/303-81 6Z 1 3/8" | 133000270156 | Arbre de prise de force PTO shaft Zapfwellenstummel Aftakasstomp Eje de toma de fuerza |
| 743XL, 744XL, 745XL, 844XL, 845XL, 856XL | 5 | 25/6678-13 Lg.: 595mm Ø 25mm | 3225611R1 | Arbre de contrôle d'effort Lower link sensing shaft Tiefenkontrollwelle Torsie-as Eje del control del alzamiento |
| 955, 955XL, 956, 956XL, 1055, 1055XL, 1056, 1056XL | | 25/6678-14 Lg.: 611mm Ø 28,5mm | 3220155R1 | |

Les références des pièces sont indicatives.
Nos pièces ne sont pas d'origine.

Part numbers are quoted for reference purposes only.
Our parts and accessories are not original.





"THE RELIABLE SERVICE"

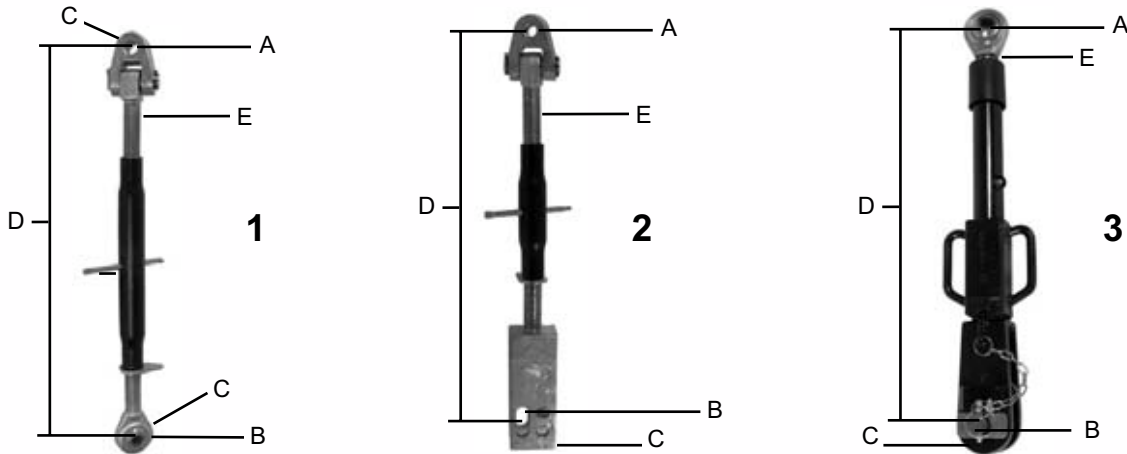

CASE-IH PARTS

SUSPENTE D'ATTELAGE ADAPTAPLE - ADATABLE LEVELLING BOX - UNIVERSAL HUBSTANGEN - HEFSTANG-AANPASBAAR - HORQUILLA NIVELADORA ADAPTAPLE



|  | Fig. | PART N° | ØA mm | ØB mm | C mm | D mm | E mm |
|---|------|-----------|----------|----------|---------|---------|---------|
| MX / MAXXUM | 2 | 25/760-81 | 20 | 25 | 31 | 530/675 | 36x3 |
| CS | 3 | 25/760-82 | 25 | 28 | 33 | 710/800 | 36x3 |
| MAGNUM | 1 | 25/760-83 | 25 | 25 | 51 | 620/850 | 36x3 |
| CVX | 3 | 25/760-84 | 32 | 28 | 33 | 710/800 | 36x3 |

BARRE DE POUSSEE - TOP LINK - OBERLENKER - TOPSTANGEN - BARRAS DEL 3^{ER} PUNTO

Côté machine - Implement side
-Machinenseitig - Machinezijde
- Con rótula

Côté tracteur - Tractor side -
Getriebeseitig - Tractorbrugzijde
- Con rótula

1" 3/4 UNC



25/701-10
(1282082C2)

7110E, 7120E, 7130, 7140, 9310, 9330, 9350,
MX180, MX200, MX220, MX240, MX270



25/703-11
(1981988C1)

7110E, 7120E, 7130, 7140, 7210, 7220,
7230, 7240, 7250, 9310, 9330, 9350



25/702-7
(1954223C3)

7110E, 7120E, 7130, 7140,
7210, 7220, 7230, 7240, 7250,
9310, 9330, 9350, MX180, MX200,
MX220, MX240, MX270



25/711-5
(1348082C1, 245301A1)

7110E, 7120E, 7130, 7140, 7210, 7220,
7230, 7240, 7250, MX180, MX200,
MX220, MX240, MX270

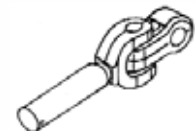

25/703-12
(319585A1)

MX180, MX200, MX220, MX240, MX270

Les références des pièces sont indicatives.
Nos pièces ne sont pas d'origine.

Part numbers are quoted for reference purposes only.
Our parts and accessories are not original.



TRACPIECES

bepco tractor parts

PRODUCT NEWS-SHEET

PAGE : N°7120
DATE : 08/2001

CASE-IH PARTS

INSTRUMENTS - INSTRUMENTS - BORDINSTRUMENTE INSTRUMENTEN - INSTRUMENTOS

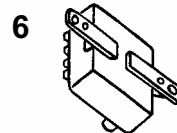
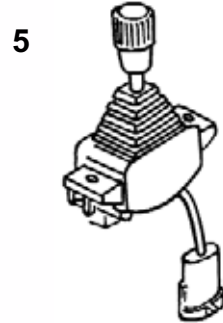

|  | Fig. | PART N° | OEM | |
|---|------|-----------|--------------|--|
| 553, 654, 724, 824, 644, 744, 844, 844S | 1 | 25/145-3 | 3055301R91 | Ventilateur - Fan blade - Lüfterflügel - Ventilatorblad - Ventilador |
| 485XL, 495XL, 585XL, 595XL, 685XL, 695XL, 785XL, 795XL, 885XL, 895XL, 995XL, 3210, 3220, 3230, 4210, 4220, 4230, 4240 | 2 | 25/187-19 | 3114409R92 | Manocontact de sécurité Safety switch Sicherheitsschalter Veiligheidsschakelaar Interruptor de seguridad |
| CS110, CS120, CS130, CS150 | 3 | 62/930-43 | 132000090705 | Démarrreur Starter motor Anlasser Starter Motor de arranque |
| 323, 353, 383, 423, 433, 453, 533, 553, 633, 644, 654, 724, 733, 743, 744, 745S, 824, 833, 844, 844S, 845, 933, 946, 1046, 1246 | 4 | 25/950-20 | 3057998R93 | Contacteur (3 fiches) Switch (3 pin) Schalter (3 steckanschlüsse) Schakelaar (3 stekkers) Interruptor (3 terminales faston) |
| 5120, 5130, 5140, 5150 | 5 | 25/958-27 | 1534361C2 | Contacteur combiné (6 positions) Combined switch (6 positions) Mehrfunktionsschalter (6 positionen) Dubbel functieschakelaar (6 posities) Palanca de mandos (6 posiciones) |
| 644, 743, 744, 745S, 844, 844S | 6 | 63/961-9 | 3141102R92 | Boîte clignotante Flasher unit Blinkgeber Knipperlightautom. Unidad de intermitencias |

Les références des pièces sont indicatives.
Nos pièces ne sont pas d'origine.

Part numbers are quoted for reference purposes only.
Our parts and accessories are not original.



"THE RELIABLE SERVICE"



CASE-IH PARTS

CONTACTEUR - SWITCH - SCHALTER - TUIMELSCHAKELAAR - INTERRUPTOR



|  | PART N° | OEM | |
|--|-----------|-----------------------|--|
| C50, C60, C80, C90, C100, 485XL, 540, 585XL, 640, 740, 743XL, 745XL, 785, 785XL, 795, 795XL, 840, 844XL, 845XL, 856XL, 885, 885XL, 895, 895XL, 940, 956XL, 995XL, 1056XL, 1255XL, 1455XL, 3210, 3220, 3230, 4210, 4220, 4230, 4240, 5120, 5130, 5140, 5150, 7110E, 7120E, 7130, 7140, 7210, 7220, 7230, 7240, 7250, | 63/967-5 | 1964835C1 | Contacteur (traction) Switch (4WD) Schalter (4WD) Tuimelschakelaar (4WD) Interruptor (tracción) |
| 485XL, 495XL, 585XL, 595XL, 685XL, 695XL, 743XL, 745XL, 785XL, 795XL, 844XL, 845XL, 856XL, 885XL, 895XL, 956XL, 995XL, 1056XL, 1255XL, 1294, 1394, 1455XL, 1494, 1594, 3210, 3220, 3230, 4210, 4220, 4230, 4240, 7210, 7220, 7230, 7240, 7250, | 63/967-6 | 245911C1 3223052R1 | Contacteur (essuie glace) Switch (screen wiper) Schalter (Scheibenwischer) Tuimelschakelaar (ruitewisser) Interruptor (escobillas) |
| C50, C60, C70, C80, C90, C100, CX50, CX60, CX70, CX80, CX90, CX100, MX100, MX110, MX120, MX135, MX150, MX170, MX80C, MX90C, MX100C, 238, 248, 258, 268, 288, 395, 440, 485XL, 495, 495XL, 540, 585XL, 595, 595XL, 640, 685, 685XL, 695XL, 740, 743XL, 745XL, 785, 785XL, 795, 795XL, 840, 844XL, 845XL, 856XL, 885, 885XL, 895, 895XL, 940, 956XL, 995XL, 1056XL, 1255XL, 1455XL, 3210, 3220, 3230, 4210, 4220, 4230, 4240, 5120, 5130, 5140, 5150, 7110E, 7120E, 7130, 7140, 7210, 7220, 7230, 7240, 7250 | 63/967-7 | 245908C1 3221208R1 | Contacteur (clignotant) Switch (flasher unit) Schalter (Blinker) Tuimelschakelaar (richtingaanwijzer) Interruptor (para intermitentes) |
| C50, C60, C70, C80, C90, C100, CX50, CX60, CX70, CX80, CX90, CX100, MX100, MX110, MX120, MX135, MX150, MX170, MX80C, MX90C, MX100C, 238, 248, 258, 268, 288, 395, 485, 485XL, 495, 495XL, 585, 585XL, 595, 595XL, 685, 685XL, 695, 695XL, 743XL, 745XL, 785, 785XL, 795, 795XL, 844XL, 845XL, 856XL, 885, 885XL, 895, 895XL, 956XL, 995XL, 1056XL, 1255XL, 1455XL, 3210, 3220, 3230, 4210, 4220, 4230, 4240, 5120, 5130, 5140, 5150, 7110E, 7120E, 7130, 7140, 7210, 7220, 7230, 7240, 7250, | 63/967-8 | 245909C1 3402632R1 | Contacteur (phare de cabine) Switch (cab light) Schalter (Kabinenscheinwerfer) Tuimelschakelaar (werkklamp) Interruptor (luces cabina) |
| 238, 248, 258, 268, 288, 395, 440, 485XL, 495, 495XL, 540, 585XL, 595, 595XL, 640, 685, 685XL, 695, 695XL, 740, 743XL, 745XL, 785, 785XL, 795, 795XL, 840, 844XL, 845XL, 856XL, 885, 885XL, 895, 895XL, 940, 956XL, 995XL, 1056XL, 1255XL, 1455XL, 3210, 3220, 3230, 4210, 4220, 4230, 4240 | 63/967-18 | 245910C1 3221180R1 | Contacteur (phare avant) Switch (front light) Schalter (Frontscheinwerfer) Tuimelschakelaar (koplamp) Interruptor (faro delantero) |



TRACPIECES

bepco tractor parts

PRODUCT NEWS-SHEET

PAGE : N°7122
DATE : 08/2001

CASE-IH PARTS

ACCESSOIRES POUR CABINE - ITEMS CAB - EINZELTEILE FÜR KABINE - ONDERDELEN VOOR KABINE - INSTRUMENTOS DE CABINA

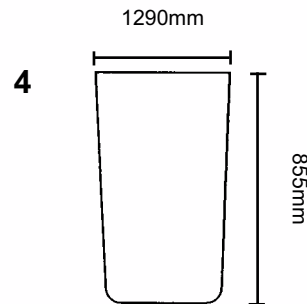
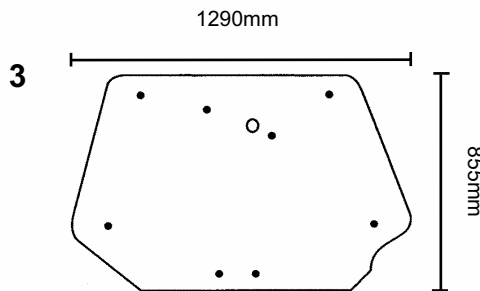

|  | FIG. | PART N° | OEM | |
|--|------|------------|--------------|---|
| CS78, CS86, CS96, CS110, CS120, CS130, CS150, CVX120, CVX130, CVX150, CVX170 | 1 | 25/870-60 | 1-99-976-061 | Etai (porte) - Gas strut (door) - Gasfeder (Tür) - Gascilinder (deur) - Amortiguador (puerta) |
| 5120, 5130, 5140, 5150 | 2 | 25/876-3 | 108157A1 | Etai (capot) - Gas strut (bonnet) - Gasfeder (Motorhaube) - Gascilinder (kap) - Amortiguador (capó) |
| CX50, CX60, CX70, CX80, CX90, CX100, MX100, MX110, MX120, MX135, MX150, MX170, MX80C, MX90C, MX100C | 3 | 25/4071-30 | 284947A1 | Vitre arrière teintée - Rear window (green) - Seitenscheibe hinten (grün) - Achterruit met uitsparing (groen) - Cristal trasero (verde) |
| 485XL, 495XL, 585XL, 595XL, 685XL, 695XL, 743XL, 745XL, 785XL, 795XL, 844XL, 845XL, 856XL, 885XL, 895XL, 955XL, 956XL, 995XL, 1055XL, 1056XL, 1255XL, 1455XL, 4230XL, 4240XL | 4 | 25/4012-61 | 3233036R1 | Vitre avant gauche (bas) - Lower front LH - Vorne (L-unten) - Voorruit (L beneden) - Cristal frontal delantero (inf.izq.) |
| | | 25/4012-62 | 3233037R1 | Vitre avant droit (bas) - Lower front RH - Vorne (R-unten) - Voorruit (R beneden) - Cristal frontal delantero (inf.drcha) |

Les références des pièces sont indicatives.
Nos pièces ne sont pas d'origine.

Part numbers are quoted for reference purposes only.
Our parts and accessories are not original.



"THE RELIABLE SERVICE"



CASE-IH PARTS

VITRERIE DE CABINE - CAB GLASS - KABINENSCHIEBEN - KABINERUITEN - CRISTAL DE CABINA

5120, 5130, 5140, 5150 MAXXUM PRO

Teintée - Green - Grün - Groen - Verde

25/4015-8
(248716A1)

Avant bas gauche - Lower front LH
Vorne (L unten) - Voor (onder links)
Frontal (inf. izq.)

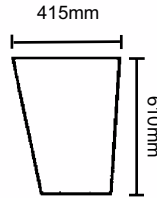

25/4016-8
(248717A1)

Avant bas droit - Lower front RH
Vorne (R unten) - Voor (onder rechts)
Frontal (inf. dcha.)

25/4030-14
(248724A1)

Vitre de porte (haut gauche) -
Upper door LH - Türscheibe (L oben) -
Deur (boven links) - Puerta (sup. izq.)

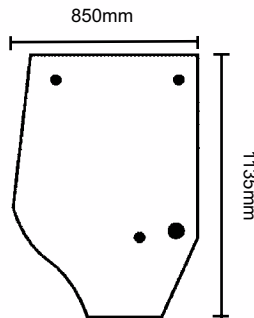

25/4031-14
(248723A1)

Vitre de porte (haut droit) - Upper door RH
Türscheibe (R oben) - Deur (boven rechts)
Puerta (sup.dcha.)

25/4032-14
(248725A1)

Vitre de porte (bas gauche) -
Lower door LH - Türscheibe (L unten) -
Deur (beneden links) - Puerta (inf. izq.)

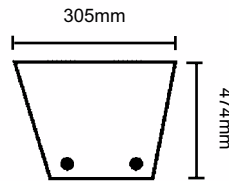

25/4033-14
(248726A1)

Vitre de porte (bas droit) - Lower door RH
Türscheibe (R unten) -
Deur (beneden rechts) - Puerta (inf.dcha.)

25/4043-14
(248718A1)

Latéral gauche - Side LH
Seitenscheibe L - Ruiten (zijkant links)
Lateral izq.

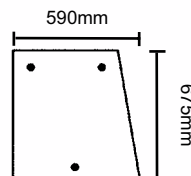

25/4045-14
(248719A1)

Latéral droit - Side RH
Seitenscheibe R - Ruiten (zijkant rechts)
Lateral dcha.

25/4072-63
(248720A1)

Arrière haut - Upper rear
Seitenscheibe hinten oben -
Achtterruit boven - Trasero superior

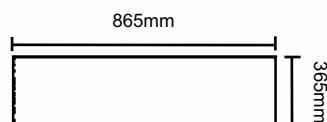
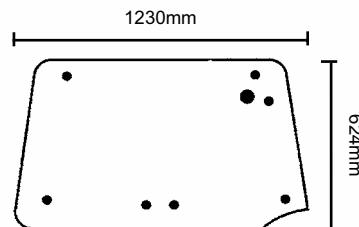

25/4073-36
(1981934C1)

Arrière bas - Lower rear
Seitenscheibe hinten unten -
Achtterruit onder - Trasero inferior



Les références des pièces sont indicatives.
Nos pièces ne sont pas d'origine.

Part numbers are quoted for reference purposes only.
Our parts and accessories are not original.

CASE-IH PARTS

Pompes à huile
Oil pumps
Ölpumpen
Oliepompen
Bombas de aceite



|  |  | PART N° | OEM |
|---|---|------------------|------------|
| 238, 248, 353, 385, 395, 423, 433, 440, 453, 484, 485, 485XL, 495XL, 533, 540, 3210 | D.155 (3 cyl.) | 25/90-35E | 3136429R95 |
| 454, 484, 485, 485XL, 495, 495XL, 523, 553, 633, 640, 3220 | D.179 (3 cyl.) | | |
| 258, 554, 585, 585XL, 595XL, 624, 644, 645, 654, 733, 740, 3230 | D.206 (4 cyl.) | 25/90-36E | 3136430R95 |
| 574, 674, 684, 685, 685XL, 695XL, 724, 743, 743XL, 744, 745S, 745XL, 833, 840, 846, 940, 4210 | D.239 (4 cyl.) | 25/90-36E | |
| 856XL | DT.239 (4 cyl.) | 25/90-38E | 3136432R95 |
| 784, 785, 785XL, 795, 795XL, 824, 4220, H84, H85 | D.246 (4 cyl.) | 25/90-36E | 3136430R95 |
| 844, 844S, 844XL, 845, 845XL, 884, 885, 885XL, 895, 895XL, 995, 995XL, 4230, 4240 | D.268 (4 cyl.) | | |
| 756, 946, 955, 955XL | D.310 (6 cyl.) | 25/90-39E | 3136433R95 |
| 956, 956XL, 1046, 1055, 1055XL, 1056, 1056XL | D.358 (6 cyl.) | | |
| 1246, 1255, 1255XL | DT.358 (6 cyl.) | 25/90-38E | 3136432R95 |
| 1455, 1455XL | DT.402 (6 cyl.) | | |



CASE-IH PARTS

Sonde de température
Temperature sender
Temperatursender
Temperatuurzender
Sensor de temperatura



|  | PART N° | OEM |
|--|-----------|---------|
| 495XL, 595XL, 695XL, 795XL, 895XL, 995XL, 3210, 3220, 3230, 4210, 4220, 4230, 4240, 5120, 5130, 5140, 5150 | 25/180-15 | A187687 |



Kit de réparation de la pompe d'alimentation
Fuel pump repair kit
Reparatursatz (für Kraftstofförderpumpe)
Revisieset opvoerpompen
Juego de reparación bomba gas-oil

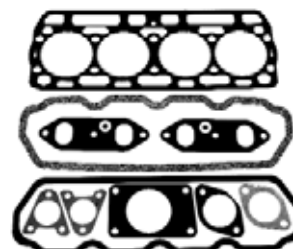

|  | PART N° | OEM |
|---|-----------|------------|
| 554, 624, 633, 644, 645, 654, 724, 733, 740, 743, 743XL, 744, 745, 745XL, 756, 833, 840, 844S, 844XL, 845S, 845XL, 846, 856XL, 946, 955, 956, 1055, 1056, 1246, 1255, 1255XL, 1455, 1455XL | 25/101-24 | 3136002R91 |

Pochette de rodage avec joint de culasse
Top gasket set with cyl. head gasket
Kopfdichtsatz mit Kopfdichtung
Kopset met koppakking
Juego de juntas superior con junta de culata



|  |  | Alésage Bore Bohrung Boring Diámetro (mm) | PART N° | OEM |
|---|---|--|-----------|------------|
| D214S, DLD2, D212, D214, D215 (2 cyl.) | DD-66 | 82.55 | 25/71-100 | 3051138R92 |
| DED-3, D320S, D322 (3 cyl.) | DD-99 | 82.55 | 25/71-102 | 3051142R92 |
| D430S, D432, D440, DGD4 (4 cyl.) | DD-132 | 82.55 | 25/71-103 | 3051146R92 |
| D217F, D217S, D219 (2 cyl.) | DD-74 | 87.31 | 25/71-101 | 3051140R92 |

INDEX

| | | | |
|---|-------|--|-------|
| Alternadores y generadores | 25 | <i>Alternators and dynamos</i> | 25 |
| Amortiguador | 29 | <i>Bearings and small end bush</i> | 3 |
| Asiento | 28 | <i>Brakes-disc and drum</i> | 18 |
| Bombas de agua y juego de reparaciòn | 7 | <i>Cab door locks and handles</i> | 27 |
| Bombas gas-oil | 6 | <i>Cab glass</i> | 30-31 |
| Bombas hidráulica | 22 | <i>Caps (miscellaneous)</i> | 10 |
| Caja niveladora, estabilizadores y accesorios | 24 | <i>Clutch assemblies and plates</i> | 16-17 |
| Calentador | 3 | <i>Cooling hoses</i> | 8 |
| Cilindro principal y receptor | 17-18 | <i>Cross references</i> | 32-38 |
| Cojinetes y retenes | 3 | <i>Cylinder head parts</i> | 5 |
| Conexiones de la bomba hidráulica | 23 | <i>Decal sets</i> | 28 |
| Corona de arranque | 10 | <i>Engine gasket sets</i> | 6 |
| Correas | 9 | <i>Fan belts</i> | 9 |
| Cristal de cabina | 30-31 | <i>Filters</i> | 11 |
| Eje delantero | 19 | <i>Front axle parts</i> | 19 |
| Embragues | 16-17 | <i>Fuel pumps</i> | 6 |
| Equipo de cilindro | 4 | <i>Gas struts</i> | 29 |
| Escobillas y motores del limpia-parabrisas | 29 | <i>Glazing rubber</i> | 29 |
| Faros de trabajos | 13 | <i>Heater plug</i> | 3 |
| Filtros | 11 | <i>Hydraulic pump drive</i> | 23 |
| Freno (Disco, tambor) | 18 | <i>Hydraulic pumps</i> | 22 |
| Goma para cristales de cabina | 29 | <i>Injector nozzle</i> | 3 |
| Instrumentos (Diversos) | 14-15 | <i>Instruments (miscellaneous)</i> | 14-15 |
| Juego calcomanías | 28 | <i>Lighting</i> | 13 |
| Juegos de direcciòn asistida | 23 | <i>Levelling box assembly, stabilisers and accessories</i> | 24 |
| Juegos segmentos | 4 | <i>Master and slave cylinders</i> | 17-18 |
| Juntas de motor | 6 | <i>Mufflers (vertical)</i> | 12 |
| Lista de referencias cruzadas | 32-38 | <i>Paint</i> | 27 |
| Luces | 13 | <i>Pistons</i> | 5 |
| Maneta de la puerta | 27 | <i>Pistons, ring sets and liners</i> | 4 |
| Manguitos radiador | 8 | <i>Power steering kits</i> | 23 |
| Motores de arranque | 26 | <i>Ring gears</i> | 10 |
| Pintura | 27 | <i>Ring sets</i> | 4 |
| Pistones | 5 | <i>Seats</i> | 28 |
| Repuestos para válvula y culatas | 5 | <i>Starter motors</i> | 26 |
| Ròtulas de direcciòn | 21 | <i>Thermostat</i> | 7 |
| Silenciosos (Vertical) | 12 | <i>Tie rods</i> | 21 |
| Tapones diversos | 10 | <i>Tractors and engine application chart</i> | 2 |
| Termostato | 7 | <i>Water pump and repair kits</i> | 7 |
| Tobera | 3 | <i>Wiper motors and blades</i> | 29 |
| Tractores y motores, tabla de aplicaciones | 2 | <i>Work lights</i> | 13 |

Las referencias originales tienen un propósito identificativo.
Nuestras piezas no son originales.

Part numbers are quoted for reference purposes only.
Our parts and accessories are not original.



"THE RELIABLE SERVICE"



TRACTORES Y MOTORES, TABLA DE APLICACIONES
TRACTORS AND ENGINE APPLICATION CHART

DAVID BROWN

DB-1 / DB-38

| Tractores Tractors | Tipo Type | Motor Engine | Tractores Tractors | Tipo Type | Motor Engine | Tractores Tractors | Tipo Type | Motor Engine |
|-----------------------|--------------|--------------------|-----------------------|--------------|--------------------|-----------------------|--------------|--------------------|
| 770 | Selectamatic | AD.3/49 | 1200 | Selectamatic | AD.4/55 | 1490 | D.B-CASE | AD.4/55T 220101 |
| 780, 880 | Selectamatic | AD.3/55 | 1210 | Synchromatic | AD.4/55 455009 | 1494 | D.B-CASE | AD.4/55T 220105 |
| 885 | Synchromatic | AD.33/55 355011 | 1212 | Synchromatic | AD.4/55 455031 | 1594 | D.B-CASE | AD.6/55T 330002 |
| 990 | Selectamatic | AD.4/49 | 1290 | D.B-CASE | AD.4/55 220004 | 1690 | D.B-CASE | AD.6/55T 330001 |
| 990 | Synchromatic | AD.4/55 449001 | 1294 | D.B-CASE | AD.4/55 220008 | 1690 TURBO | D.B-CASE | AD.6/55T 330101 |
| 995 | Synchromatic | AD.4/55 455051 | 1390 | D.B-CASE | AD.4/55 220002 | 1694 | D.B-CASE | AD.6/55T 330102 |
| 996 | Synchromatic | AD.4/55 455071 | 1394 | D.B-CASE | AD.4/55T 220103 | | | |
| 1190, 1194 | D.B-CASE | AD.3/55 165004 | 1410, 1412 | Synchromatic | AD.4/55T 455011 | | | |

CASE-IH EUROPE

CIH-1 / CIH-57

| Tractores Tractors | Motor Engine | Tractores Tractors | Motor Engine | Tractores Tractors | Motor Engine |
|---|----------------------|--------------------------|---------------------|----------------------------|------------------------------------|
| D.217, D.217S, D.219 | DD.74 (2 cil./cyl) | 856XL | DT.239 (4 cil./cyl) | MAXXUM 5140 | 6T-590 (6 cil./cyl) |
| D.324, D.326 | DD.111 (3 cil./cyl) | 824, 844 | D.246 (4 cil./cyl) | MAXXUM 5150 | 6T-690 (6 cil./cyl) |
| 323 | DU.111 (3 cil./cyl) | 844S, 845S, 845XL | D.268 (4 cil./cyl) | MAGNUM 7110, 7120 | 6T-830 (6 cil./cyl) |
| D.436, DTD.5 | DD.148 (4 cil./cyl) | 756, 946, 955 | D.310 (6 cil./cyl) | MAGNUM 7130 | 6T-830 / 6CT-830 (6 cil./cyl) |
| D.439 | DU.148D (4 cil./cyl) | 956, 1046, 1055, 1056 | D.358 (6 cil./cyl) | MAGNUM 7140 | 6TA-830 / 6CTA-830 (6 cil./cyl) |
| 353, 383, 423, 433, 440, 453, 533, 540 | D.155 (3 cil./cyl) | 1246, 1255 (+ XL) | DT.358 (6 cil./cyl) | | |
| 523, 553, 633, 640 | D.179 (3 cil./cyl) | 1455 (+ XL) | DT.402 (6 cil./cyl) | MAGNUM 7210, 7220, 7230 | 6T-830 (6 cil./cyl) |
| 554, 624, 644, 645, 654, 733, 740 | D.206 (4 cil./cyl) | MAXXUM 5120 | 4T-390 (4 cil./cyl) | MAGNUM 7240 | 6TI-830 (6 cil./cyl) |
| 724, 743, 744, 745, 833, 840, 846 | D.239 (4 cil./cyl) | MAXXUM 5130 | 6-590 (6 cil./cyl) | MAGNUM 7250 | 6TIR-830 (6 cil./cyl) |

CASE-IH ENGLAND

CIHE-1 / CIHE-48

| Tractores Tractors | Motor Engine | Tractores Tractors | Motor Engine | Tractores Tractors | Motor Engine |
|----------------------------|---------------------------|-----------------------------|--------------------------|----------------------------------|--------------------------|
| 275, 276, 354 | BD.144 (4 cil. / cyl.) | 454, 484, 485, 495, 3220 | D.179 (3 cil. / cyl.) | 574, 674, 684, 685, 695, 4210 | D.239 (4 cil. / cyl.) |
| 374, 384, 414, 434, 444 | BD.154 (4 cil. / cyl.) | 474, 584, 585, 595, 3230 | D.206 (4 cil. / cyl.) | 784, 785, 795, 4220 | D.246 (4 cil. / cyl.) |
| 385, 395, 3210 | D.155 (3 cil. / cyl.) | 475 | Perkins A4.212 | 884, 885, 895, 4230 | D.268 (4 cil. / cyl.) |

Las referencias originales tienen un propósito identificativo.
Nuestras piezas no son originales.

Part numbers are quoted for reference purposes only.
Our parts and accessories are not original.



"THE RELIABLE SERVICE"



COJINETES Y RETENES
BEARINGS & SMALL END BUSH

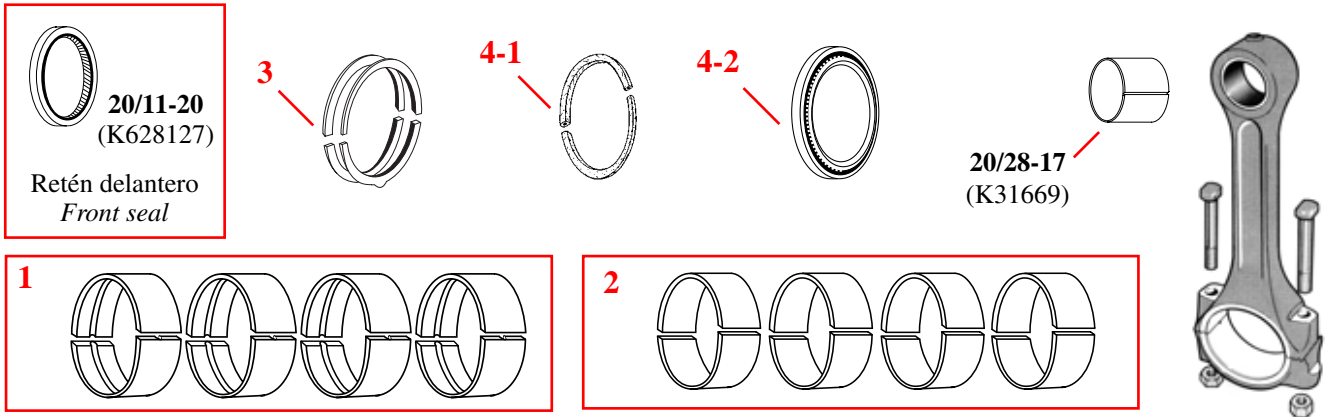

| Fig. | 1 | 2 | 3 | 4 | 5 |
|--|--------------------------------------|---|---|--|---|
| Tractores Tractors | Cigñales Crankshaft | Juego de cojinetes de bancada Main bearing set | Juego de cojinetes de biela Conrod bearing set | Juego de axiales Washer kit | Rétén trasero Rear seal |
| 770, 780, 880, 885, 1190, 1194 (3 cil./ cyl.) | | 20/2-30 (8 x K928540) | 20/3-30 (6 x K207436) | 20/6-20 (2 x K928542, 2 x K928543) | 20/13-18 (2x K921611) 5-1 |
| 990, 995, 996, 1200, 1210, 1212, 1290, 1294, 1390, 1394 (4 cil./ cyl.) | 20/1-65 (K210100) | 20/2-31 (6 x K928541) | 20/3-31 (8 x K207436) | | |
| 1410, 1412, 1490, 1494 (4 cil./ cyl.) | | 20/2-32 (6 x K928997) | 20/3-32 (8 x K929148) | 20/6-22 (2 x K928998, 2 x K928999) | 20/13-19 (K940135) 5-1 |
| 1594, 1690, 1690T, 1694 (6 cil./ cyl.) | | 20/2-33 (12 x K917637, 2 x K917639) | 20/3-33 (12 x K207436) | 20/6-24 (2 x K917635, 2 x K917636) | 20/13-20 (K306765) 5-2 |

Los casquillos de bancada y biela están disponibles a 0,010" y 0,020". Añadir en el pedido el sufijo A o B respectivamente. Ver las referencias cruzadas para encontrar la referencia original.

All main and con-rod bearing sets are stocked in .010" and .020" undersize. When ordering please suffix BEPCO part number A or B respectively. See Cross-reference list for equivalent David Brown numbers.

Juego de arandelas axiales 0,005" disponibles :
.005" thrust washer set are available :

- 20/6-21** (B621) [2x K928560 + 2x K928561]
- 20/6-23** (B623) [2x K946347 + 2x K946348]
- 20/6-25** (B625) [2x K204974 + 2x K204975]

TOBERA/ INJECTOR NOZZLE



20/117-49
(K942176)

780, 880, 885, 900, 990, 995, 996, 1190, 1194, 1200, 1210, 1212, 1290, 1294, 1390, 1394, 1410, 1412, 1490, 1494, 1594, 1690, 1690T, 1694

BOMBA DE ACEITE
OIL PUMP

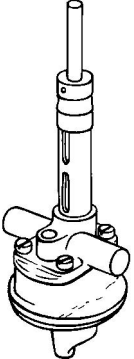

20/90-42
(K953894)

1410, 1412, 1490, 1494

CALENTADOR/ HEATER PLUG

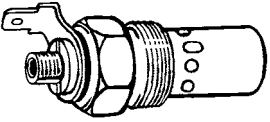

20/60-2
(K928523)

Todos los motores
Fits all engines

Las referencias originales tienen un propósito identificativo.
Nuestras piezas no son originales.

Part numbers are quoted for reference purposes only.
Our parts and accessories are not original.



EQUIPO DE CILINDRO
PISTONS, RING SETS & LINERS

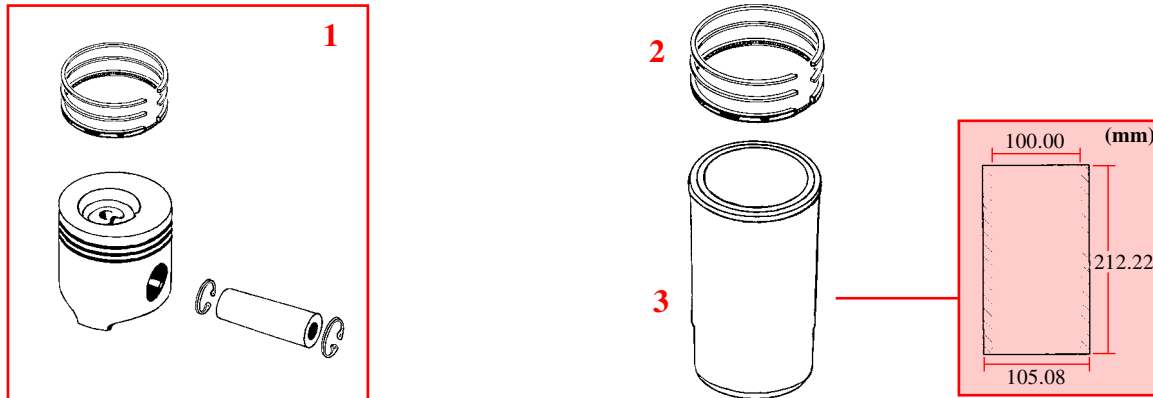



| Fig. | 1 | 2 | 3 |
|--|---|---|---|
| Tractores <i>Tractors</i> | Pistón sin aros <i>Piston & ring sets</i> | Juego de segmentos <i>Ring sets</i> | Camisa-semi <i>Semi finished liner</i> |
| Modelos antiguos/ <i>Old tractors</i> 30D, 880, 900, 950, 990 | | 20/34-79 (K67922) Ø 92,07 mm | |
| 770, 990, 1290 (↔ 11052360) | 20/32-80 (K949721) | 20/34-80 (K261069) Ø 100, 046 mm | 20/36-80 (K964857) sin pestaña <i>less flange</i> |
| 780, 880, 885, 995, 996, 1190, 1194, 1210, 1212, 1290 (11052361 ↔), 1294, 1390 | 20/32-81 (K949474) | | |
| 1410, 1412, 1394, 1490, 1494, 1690, 1690 Turbo | 20/32-82 (K944573) | | |
| 1594, 1694 | 20/32-83 (K206954) | | |

Para montar estas camisas puede ser necesario la rectificación del bloque de motor.
In some cases, the mounting of these liners requires a adjustment of the cylinder block liner's fitment.

Los pistones y juegos de aros están disponibles en versión sobremedida 0,020". Añadir el sufijo B a la referencia Bepco. Ver equivalencias con referencias Davis Brown en la lista cruzada.

All pistons and ring sets are stocked in .020" oversize. When ordering please suffix BEPCO part number B. See Cross-reference list for equivalent David Brown numbers.

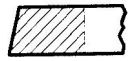
JUEGOS COMPLETOS DE SEGMENTOS
RING SETS

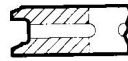
| Referencia <i>References</i> | Motores <i>Engines</i> | Ø piston <i>Bore dia.</i> | | | | |
|---------------------------------|---|------------------------------|---|---|--|--|
| 20/34-80 | AD3/49, AD4/49, AD3/55, AD4/55, AD4/55T, AD6/55, AD6/55T | 100.00mm |  CT1 2.38 |  T1 2.38 |  T1 2.38 |  BB 4.76 |

CT1 : Exteriormente cónico, cromado / *Chrome plated taper faced*

T1 : Exteriormente cónico / *Taper faced plain*

BB : Doble biseles opuestos / *Double bevelled edge*

Las referencias originales tienen un propósito identificativo.
Nuestras piezas no son originales.

*Part numbers are quoted for reference purposes only.
Our parts and accessories are not original.*



PISTONES
PISTONS

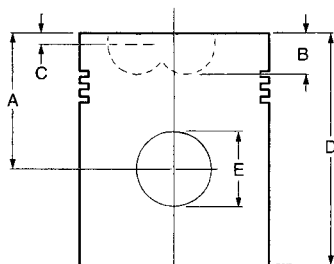
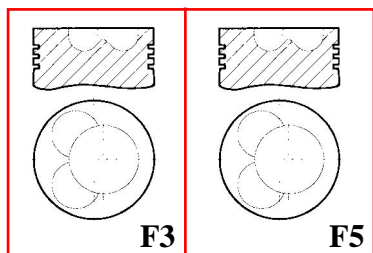

- A : Altura de compresión (mm)
Compression height (mm)
- B : Profundidad camara de combustión (mm)
Combustion bowl depth (mm)
- C : Profundidad del rebaje para valvulas
Valve pocket depth
- D : Longitud total (mm) / Overall length (mm)
- E : Diámetro bulón (mm)
Gudgeon pin diameter (mm)

| Referencia References | Motor Engine | Ø piston Bore dia. | Tipo Type | Número de aros N° of Rings | Alfín Al-fin | A | B | C | D | E |
|--------------------------|--------------------|-----------------------|--------------|-------------------------------|-----------------|------------|-------|------|--------|-------|
| 20/33-80 | AD3/49 | 100.00mm | F3 | 4 | | 66.60 | 15.80 | 5.50 | 111.80 | 31.75 |
| 20/33-81 | AD3/55 AD4/55 | | | | | | | | 105.50 | |
| 20/33-82 | AD5/55T AD6/55T | | | | | Oui Yes | 60.30 | | 20.20 | |
| 20/33-83 | AD6/55 | | F5 | | | | | | | |

Disponible a sobremedida 0.020". Añadir sufijo B.
Also available in .020" oversize, order suffix B.

REPUESTOS PARA VÁLVULAS Y CULATAS
CYLINDER HEAD PARTS

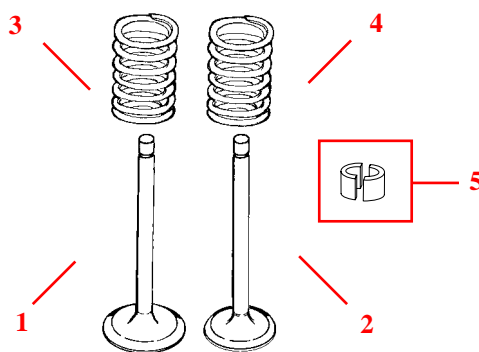

| Fig. | 1 | 2 | 3 | 4 | 5 |
|---|--|---|---|--|-----------------------------------|
| Tractores Tractors | Válvula adms. Inlet valve | Válvula escape Exhaust valve | Muelle de válvula adms. Inner spring | Muelle de válvula escape Outer spring | Semiconos Cotter |
| 780 (6039 ⇄), 880 (25306 ⇄), 880 (2984 ⇄), 885, 990 (15240 ⇄), 995, 996, 1190, 1194, 1200 (11930 ⇄), 1210, 1212, 1290, 1294, 1390, 1690 | 20/42-30 (K928622) | 20/42-30 (K928622) | 20/44-16 (K921435) | 20/45-16 (K921436) | 20/46-4 (K943439) |
| 1394, 1410, 1412, 1490, 1494, 1594, 1690 Turbo, 1694 | | 20/43-31 (K950100) | | | |

Las referencias originales tienen un propósito identificativo.
Nuestras piezas no son originales.

Part numbers are quoted for reference purposes only.
Our parts and accessories are not original.



**JUNTAS DE MOTOR
ENGINE GASKET SETS**

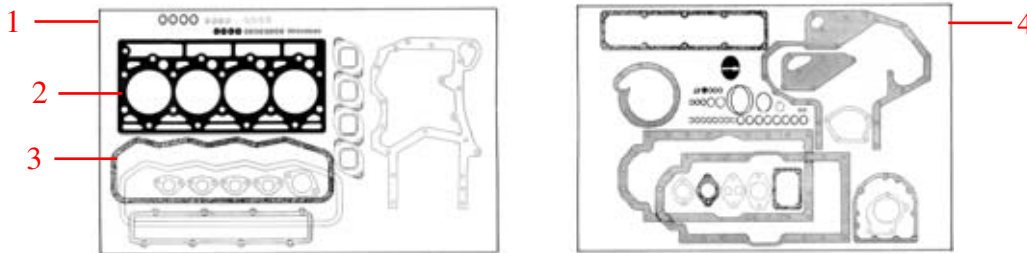

Los retenes delanteros y traseros están incluidos
Front and rear seals included

| Fig. | 1 | 2 | 3 | 4 |
|---|---|----------------------------------|---------------------------------------|---|
| Tractores Tractors | Juego de juntas superior Top gasket set | Junta culata Cyl. head gasket | Junta balancín Rocker cover gasket | Juego de juntas completo Bottom gasket set |
| 990 (1961-1/68) Implematic | 20/71-93 (K961001) | | | |
| 770, 780, 880, 885 (3 cil./ cyl.) | 20/71-60 (K964876) | 20/73-60 (K956672) | 20/74-33 (K907338) | 20/72-60 (K964877) (A) |
| 1190, 1194 (3 cil./ cyl.) | 20/71-62 (K260287) | | | 20/72-62 (K260286) |
| 990, 995, 996, 1200, 1210, 1212, 1410, 1412 (4 cil./ cyl.) | 20/71-61 (K964883, K260283, K260284, K260285) | 20/73-61 (K953783) | 20/74-34 (K905229) | 20/72-61 (K965803, K260282) |
| 1290 (4 cil./ cyl.) | | | | |
| 1294, 1390 (4 cil./ cyl.) | | | | |
| 1394, 1490, 1494 (4 cil./ cyl.) | | | | |
| 1594, 1690, 1690T, 1694 (6 cil./ cyl.) | 20/71-63 (K965964) | 20/73-63 (K952527 x2) | 20/74-35 (K918689 x2) | 20/72-63 (K965963) |

(A) Los retenes delanteros y traseros no están incluidos / *Front and rear seals not included*

BOMBA GAS-OIL / FUEL PUMPS

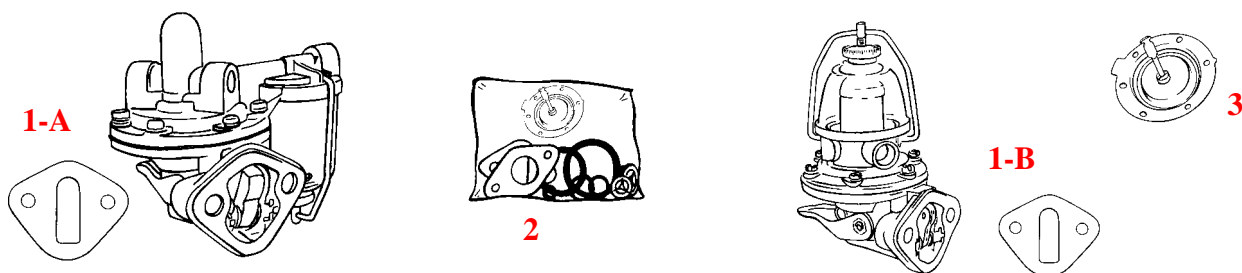

| Fig. | 1 | 2 | Cubeta Glass bowl | 3 |
|--|-------------------------------|-----------------------------------|-----------------------|-------------------------|
| Tractores Tractors | Bombín Pump | Juego de reparación Repair kit | | Membrana Diaphragm |
| 850, 880 (4 cil./ cyl.), 900 ⇄ 1964 | | | | |
| 770, 780, 880 (3 cil./ cyl.), 885, 990 Select. | 20/100-56 (K908819) 1-A | 20/101-56 (K262265) | 20/102-2 (K961733) | 20/101-56M (K911917) |
| 990 Synchro, 995, 996, 1190, 1194, 1200, 1210, 1212, 1290, 1294, 1390, 1394, 1410, 1412, 1490, 1494, 1594, 1690, 1690T, 1694 | 20/100-57 (K944997) 1-B | | 20/102-3 (K66442) | |

Las referencias originales tienen un propósito identificativo.
Nuestras piezas no son originales.

Part numbers are quoted for reference purposes only.
Our parts and accessories are not original.



BOMBAS DE AGUA Y JUEGO DE REPARACIÓN
WATER PUMP AND REPAIR KITS

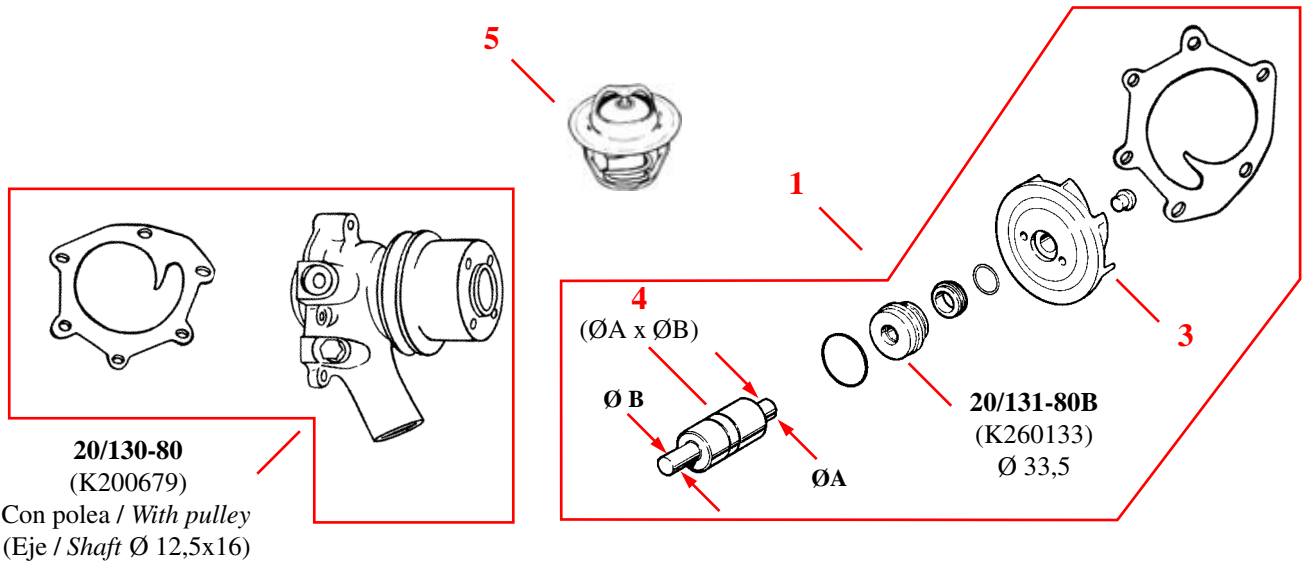

| Fig. | | 1 | | 3 | 4 | 5 |
|---|---|--------------------------------------|-----------------|---|--|---|
| Tractores Tractors | Bomba Water pump | Juego de reparación Repair kit | Junta Gasket | Turbina Impeller | Eje Shaft | Termostato Thermostat |
| 770, 780, 880, 990 Select. (3) | | 20/131-84 (K961770) (1) | | | | |
| 990 Synchro (⇄ 44689), 995 (⇄ 43796), 996 (⇄ 57526), 1200, 1210 (⇄ 26962 / SIMMS), 1210 (⇄ 25542 / BOSCH), 1212 (⇄ 19329) | | 20/131-85 (K964489) (1) | | 20/131-85D (K915329) Ø 73x12,5 Ht. 33mm | 20/131-85A (K11651) Ø 12,5x16 | 20/143-80 (K200831) Ø 52mm |
| 990 Synchro (44690 ⇄ 56494), 995 (43797 ⇄ 54149), 996 (57527 ⇄ 67672), 1210 (26963 ⇄ 752670 / SIMMS), 1210 (25542 ⇄ 803830 / BOSCH), 1212 (19330 ⇄ 23904), 1410 (⇄ 126063), 1412 (⇄ 126063) | 20/130-80 (K200679, K200822) | 20/131-80 (K965848) (2) | | 20/131-80D (K943357) Ø 76x12,5 Ht. 24mm | | |
| 990 Synchro (56495 ⇄), 995 (54150 ⇄), 996 (67673 ⇄), 1210 (752671 ⇄ / SIMMS), 1210 (803831 ⇄ / BOSCH), 1212 (23905 ⇄), 1410 (126064 ⇄), 1412 (126064 ⇄) | | 20/131-86 (K965860) (1) | | 20/131-86D (K200687) Ø 76x16 Ht. 24mm | Ø 16x16 | |
| 1190, 1194, 1290, 1294, 1390, 1394, 1490, 1494, 1594, 1690, 1690 T, 1694 | | 20/131-87 (K965888) (1) | | | 20/131-87A (K620202) Ø 16x19 | 20/143-87 (K208039) Ø 54mm |

(1) Sin turbina/ Less impeller
(2) Con turbina/ With impeller
(3) Blanca / White

Las referencias originales tienen un propósito identificativo.
Nuestras piezas no son originales.

Part numbers are quoted for reference purposes only.
Our parts and accessories are not original.



MANGUITOS RADIADOR
COOLING HOSES

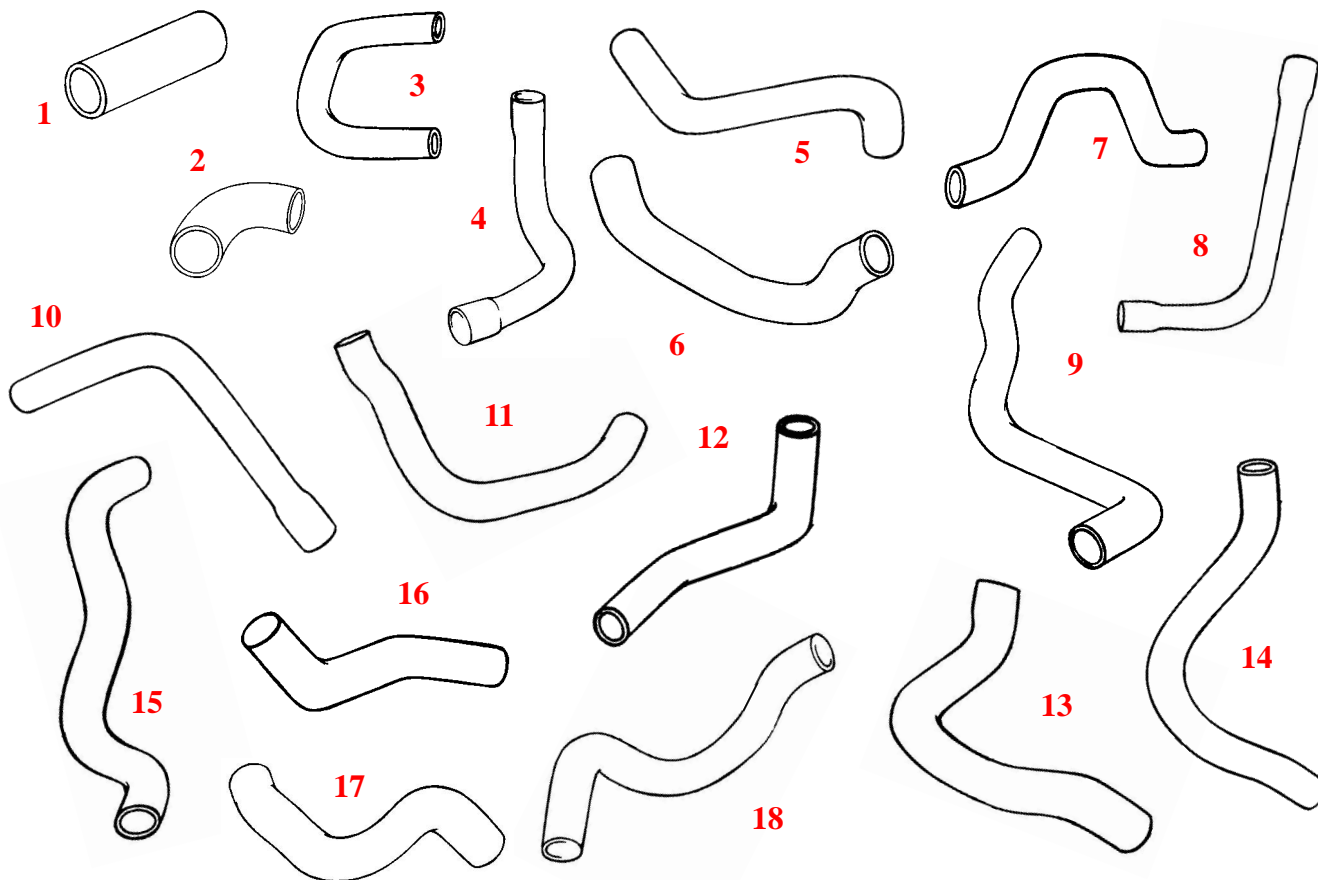

| Tractores Tractors | Fig. Fig. | Superior Top hose | OEM | Fig. Fig. | Inferior Bottom hose | OEM |
|--|--------------|----------------------|---------|--------------|-------------------------|---------|
| 770, 780 (Modelo antiguo/ Old models) | 1 | 20/153-80 | K37575 | 6 | 20/154-75 | K912034 |
| 770, 880 Selectamatic, 880 (Doble tracción/ 4 WD), 885 Synchro | | | | 7 | 20/154-76 | K915206 |
| 880 (⇔ S.550031), 850, 950 | | | | 8 | 20/154-77 | K904880 |
| 880 (S.550032 ⇔) | | | | 9 | 20/154-78 | K912039 |
| 900, 950 | | | | 10 | 20/154-79 | K88481 |
| 990 Implematic | | | | 11 | 20/154-80 | K906875 |
| 990 Selectamatic, 990 Synchro | 2 | 20/153-81 | K921972 | 12 | 20/154-86 | K926603 |
| 995, 996, 1210, 1212, 1200 Selectamatic | | | | 13 | 20/154-81 | K948453 |
| 1410, 1412 | 3 | 20/153-82 | K946849 | 14 | 20/154-82 | K945287 |
| 1190 (Sin cabina/ Less cab) | 1 | 20/153-80 | K37575 | 15 | 20/154-87 | K200874 |
| 1190 (Con cabina/ With cab) | | | | 16 | 20/154-88 | K203991 |
| 1290, 1294, 1390, 1394 | 4 | 20/153-83 | K200730 | 17 | 20/154-83 | K201976 |
| 1490, 1494 | 5 | 20/153-84 | K201747 | 18 | 20/154-84 | K203350 |
| 1594, 1690, 1690 Turbo, 1694 | | 20/153-85 | K201718 | | | |

Las referencias originales tienen un propósito identificativo.
Nuestras piezas no son originales.

Part numbers are quoted for reference purposes only.
Our parts and accessories are not original.



"THE RELIABLE SERVICE"



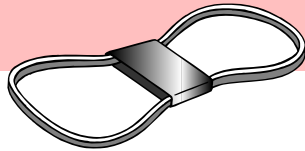

CORREAS
FAN BELTS

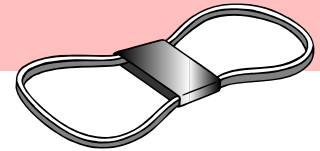







| Tractores <i>Tractors</i> | Alternador <i>Alternator</i> | Bomba de agua <i>Water pump</i> | Generador <i>Dynamo</i> |
|--|--|------------------------------------|--|
| 750,775 | | | 71/144-84 (K903050) AV.10-1150 |
| 770, 780 | 71/144-81 (K942053) AV.10-1060 | | 71/144-80 (K912196) AV.10-1090 |
| 850 | 71/144-84 (K903050) AV.10-1150 | | 71/144-82 (K68073) AV.10-1175 |
| 880 (3 cyl.) | 71/144-81 (K942053) AV.10-1060 | | 71/144-80 (K912196) AV.10-1090 |
| 880 (4 cyl.) | 71/144-82 (K68073) AV.10-1175 | | |
| 880 (4 cyl.), 885 <i>Dirección asistida./ With P.W.</i> | 71/144-84 (K903050) AV.10-1150 | | |
| 885 | 71/144-81 (K942053) AV.10-1060 | | 71/144-80 (K912196) AV.10-1090 |
| 900, 990 (Rojo / Red) | | | 71/144-88 (K901111) AV.10-1140 |
| 950 | | | 71/144-84 (K903050) AV.10-1150 |
| 990, 995, 996 | 71/144-80 (K912196) AV.10-1090 | | 71/144-82 (K68073) AV.10-1175 |
| 990, 995, 996 <i>Selectamatic</i> | 71/144-84 (K903050) AV.10-1150 | | |
| 1190, 1194 | 71/144-81 (K942053) AV.10-1060 | | 71/144-80 (K912196) AV.10-1090 |
| 1200, 1210, 1212, | 71/144-84 (K903050) AV.10-1150 | | 71/144-82 (K68073) AV.10-1175 |
| 1210, 1212, 1290, 1294, 1390, 1394, 1410, 1412, 1490, 1494 <i>Con aire acondicionado</i> <i>With air conditioning</i> | 71/144-85 (K308448) AV.13-1275 | | |
| 1290, 1294, 1390, 1394, 1410, 1412, 1490, 1494, | 71/144-82 (K68073) AV.10-1175 | | |
| 1594, 1690, 1694 | 71/144-83 (K949311) AV.10-1250 | | |

Las referencias originales tienen un propósito identificativo.
Nuestras piezas no son originales.

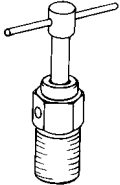
Part numbers are quoted for reference purposes only.
Our parts and accessories are not original.

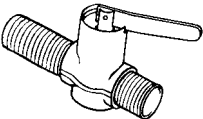

TAPONES DIVERSOS
CAPS (MISCELLANEOUS)

| | | | |
|---|---|--|---|
|  | 20/55-80 (K622060) | Tapón radiador/ <i>Drain tap</i> | Todos los tractores/ <i>All tractors</i> |
| | 20/55-80 (K622060) | Grifo de radiador/ <i>Drain cock</i> | 770, 780, 880, 885 (⇔ 41054), 990, 990 Synchronomatic (⇔ 48463), 995 (⇔ 7448), 996 (⇔ 60665), 1200, 1210 (⇔ 27161), 1410 (⇔ 121788), 1412 (⇔ 121788) |
|  | 20/55-81 (K19581) | Tapón carter/ <i>Drain cock</i> (1/4") | 885 Synchronomatic (41055 ⇔), 990 Synchronomatic (48464 ⇔), 995 (7449 ⇔), 996 (60666 ⇔), 1190, 1194, 1210 (27162 ⇔), 1212 (20682 ⇔) 1290, 1294, 1390, 1394, 1410 (121789 ⇔), 1412 (121789 ⇔), 1490, 1494, 1594, 1690, 1690 TURBO, 1694 |
|  | 20/151-80 (K906196, K945363) | Tapón radiador <i>Radiator cap</i> Presión/ <i>pressure</i> 4 Lbs., Altura/ <i>height</i> 27 mm | 770 Selectamatic , 780 Selectamatic , 880 Selectamatic , 885 Synchronomatic , 990 Selectamatic, 990 Synchronomatic, 995, 996, 1200, 1210, 1212, 1410, 1412 |
| | 20/151-81 (K902092, K945362) | Tapón radiador <i>Radiator cap</i> Presión/ <i>pressure</i> 7 Lbs., Altura/ <i>height</i> 21 mm | 885 Synchronomatic, 990 Synchronomatic, 995, 996, 1190, 1194, 1210, 1212, 1290, 1390, 1410, 1412, 1490, 1494, 1594, 1690, 1690 Turbo, 1694 |
|  | 20/105-80 (K304590, K901983) | Tapón depósito <i>Fuel tank cap</i> | Todos los tractores/ <i>Fits all tractors</i> |
|  | 20/103-80 (K622061) | Grifo de depósito <i>Fuel tap</i> | 780, 880, 990 Synchronomatic, 995, 996, 1210, 1212, 1410, 1412 |
|  | 20/85-80 (K948427 K902118) | Tapón aceite <i>Oil filler cap</i> | 990, 995, 996, 1194, 1200, 1210, 1212, 1290, 1294, 1394, 1410, 1412, 1490, 1494, 1594, 1690, 1694 |

CORONA DE ARRANQUE / RING GEARS

| | |
|------------------------------|--|
| 20/15-80 (K36134) | (112 dientes / <i>Teeth</i>) 770, 780, 880, 885, 990, 995, 996, 1190, 1194, 1200, 1210, 1212, 1290, 1390 |
| 20/15-81 (K946819) | (115 dientes / <i>Teeth</i>) 1294, 1394, 1410, 1412, 1490, 1494 |
| 20/15-82 (K917891) | (131 dientes / <i>Teeth</i>) 1594, 1690, 1690T, 1694 |



FILTRO DE CABINA
CAB FILTER

60/4200-1
(K303737)
377x245x52mm

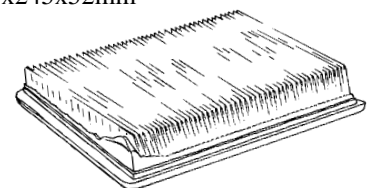

1190, 1194, 1290, 1294, 1390, 1394,
1490, 1494, 1594, 1690, 1694

Las referencias originales tienen un propósito identificativo.
Nuestras piezas no son originales.

Part numbers are quoted for reference purposes only.
Our parts and accessories are not original.



**FILTROS
FILTERS**

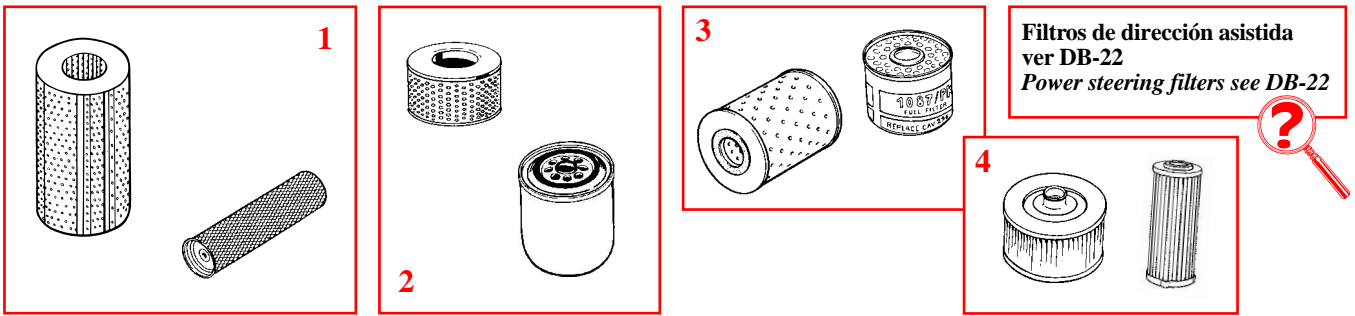

Filtros de dirección asistida
ver DB-22
Power steering filters see DB-22

| Tractores Tractors | 1 Aire / Air | | 2 Aceite Oil | 3 Combustible Fuel | 4 Hidráulico Hydraulic |
|--|---|------------------------------|---|--|---|
| | Ext. / Out. | Int. / Inn. | | | |
| 25D, 28D, 30D, 50D, 900, 950 | | | 60/96-3 (K62185) | 60/111-2 (K62594) | |
| 770, 780, 850, 885, 900, 950, 990, 995, 996 | | | 60/96-18 (K902125) (Cartucho Cartridge) 60/97-4 (K200037) 1978 ⇄ (Roscado / Spin-on) | 60/111-1 (K68859) Ø 71mm o / or 60/111-2 (K62594) Ø 86mm o / or 60/111-3 (K960911) (Repl. CAV296) | 60/240-8 (K914441) Ø 72mm o / or 60/240-19 (K920522) Ø 152mm |
| 1200, 1210, 1212, 1394, 1410, 1412, 1494 | 60/161-90 (K945043) Ht.: 265mm | | | | 60/240-19 (K920522) Ø 152mm |
| 1190, 1194, 1290, 1294, 1390, 1490, 1690 | 60/161-4 (K200379) Ht.: 288mm | 60/162-4 (K200380) | 60/97-4 (K200037) Ht.: 95mm | 60/111-3 (K960911) (Repl. CAV296) | 60/240-19 (K920522) Ø 152mm o / or 60/240-18 (K210049) Ø 78,6mm |
| 1594, 1690 Turbo, 1694 Turbo | 60/161-89 (K306535) Ht.: 345mm | | 60/97-2 (K955687) Ht.: 140mm | | 60/240-18 (K210049) Ø 78,6mm |

**CUBETA
GLASS FUEL BOWLS**

60/112-1
(7111/403)



Tipo / Model : CAV
Base plana/ Flat bottom
Altura/ Height 54 mm
Ø agujero / hole Ø : 25,4mm

60/112-2
(7111/429)



Tipo / Model : CAV
Base convexa/ Convex bottom
Altura/ Height 43 mm
Ø agujero / hole Ø : 17,4mm

**CUBETA DE PRE-FILTRO DE AIRE
PRE-CLEANER BOWLS**

60/169-10
(K260382)

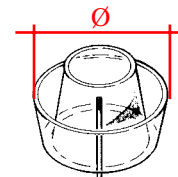

Tipo / Model DONALDSON
Ø 180mm
Económica / Economic

60/169-12
(K260907)

Tipo / Model BURGESS
Ø 162mm
Económica / Economic

Las referencias originales tienen un propósito identificativo.
Nuestras piezas no son originales.

Part numbers are quoted for reference purposes only.
Our parts and accessories are not original.



**SILENCIOSOS (VERTICAL)
MUFFLERS (VERTICAL)**

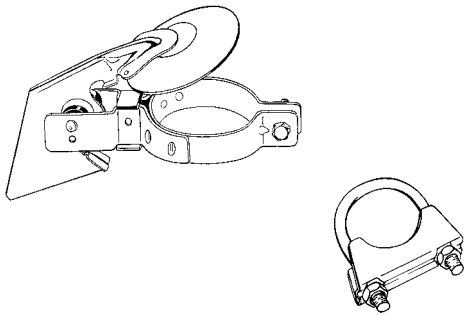

**SOPORTES DEL ESCAPE
SILENCER BRACKET**

20/164-81
(K952969) (Ø 47,5mm-1"7/8)
990, 995, 996, 1200, 1210, 1212

20/164-80
(K928275) (Ø 41mm- 1"5/8)
770, 780, 850, 880, 885, 900, 950

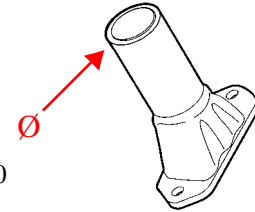

1

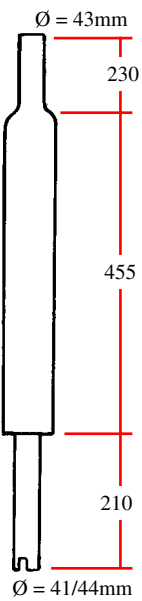

| Tractores Tractors | Fig. | Ovalado Oval | Redondo Round | Tapa Weathercap | Abrazadera Exhaust clamp |
|--|------|------------------------|------------------------|-------------------------|-----------------------------|
| 770, 780, 850, 880, 885, 900, 950 Modelos antiguos/ old range | 1 | | 20/165-72 (K914137) | | 70/2935-45 (MC5855) |
| 780, 880, 885, 990, 995, 996, 1200, 1210, 1212 | 2 | 20/165-80 (K928712) | | 70/2930-45 (5870/10) | 70/2935-48 (MC5863) |
| 995, 996, 1210, 1212 | 3 | | 20/165-88 (K954090) | | |
| 1190, 1194 | 4 | 20/165-74 (K304290) | | 70/2930-51 (5870/21) | Pestaña Flange |
| 1290, 1294, 1390 | 5 | 20/165-77 (K302952) | | | |
| 1394, 1490, 1494, 1690, 1690T, 1694 | 6 | | 20/165-78 (K306484) | 70/2930-57 (5870/22) | 70/2935-54 (MC5856) |
| 1410, 1412 | 7 | 20/165-76 (K952488) | | | |
| 1594, 1690 | 8 | 20/165-89 (K304708) | | | Pestaña Flange |

2

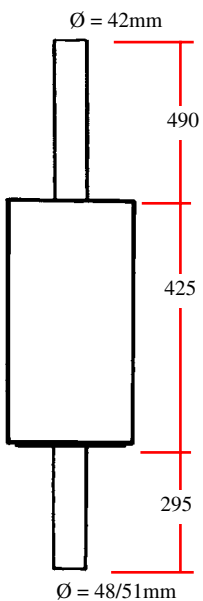

3

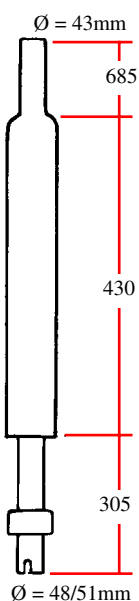

4

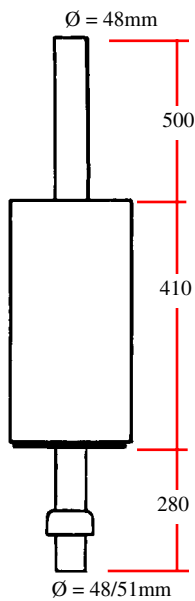

5

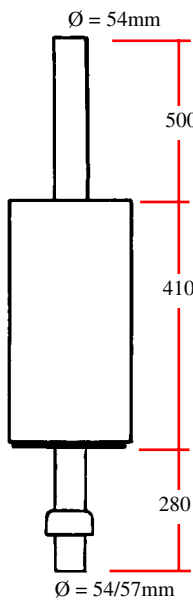

6

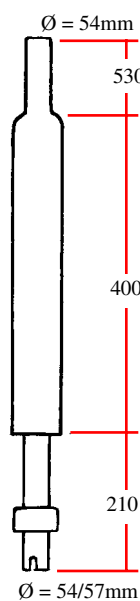

7



8

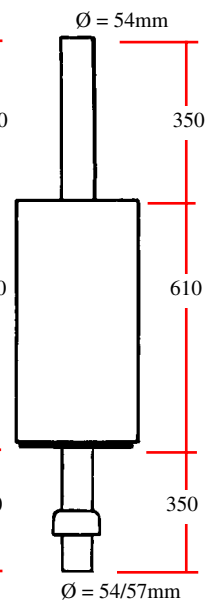

Las referencias originales tienen un propósito identificativo.
Nuestras piezas no son originales.

Part numbers are quoted for reference purposes only.
Our parts and accessories are not original.



**LUCES
LIGHTING**

FAROS "COBO" LIGHTS

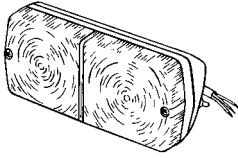
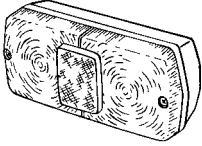
| | | | | |
|--|---|---|---|--------------------------|
| 20/1918-5 20/1918-6 20/1919-5 63/1955-382 63/1955-207 | K300194 K300195 K260911 10/12498 10/12821 | Luz delantera derecha / RH front light Luz delantera izquierda / LH front light Tulipa blanca-amarilla / White-yellow glass <u>Bombilla/ Bulb</u> <u>Bombilla/ Bulb</u> |  | Serie "90" "90" serie |
| 20/1912-22 20/1912-23 20/1913-22 63/1955-380 63/1955-382 | K300190 K300189 K260880 10/12500 10/12498 | Luz trasera izquierda / LH rear light Luz trasera derecha / RH rear light Tulipa / Glass for rear lights <u>Bombilla/ Bulb</u> <u>Bombilla/ Bulbs</u> |  | Serie "90" "90" serie |

FAROS "HELLA" LENS

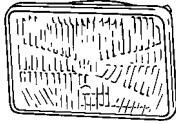
| | | | | |
|--------------------------|-----------------------|---|---|----------------------------------|
| 20/181-22 63/1955-472 | 1333291C1 10/12342 | Faro delantero 163 x 104 (izq. ou drcha.) Head lamp 163 x 104 (LH or RH) <u>Bombilla H4 / H4 Bulb</u> |  | Series 90 & 94 90 & 94 Series |
|--------------------------|-----------------------|---|---|----------------------------------|

FAROS "LUCAS" LENS

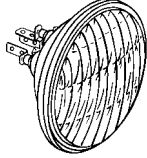
| | | | | |
|-----------|---------|---|---|---------------------------------------|
| 20/181-17 | K962146 | Faro delantero Ø 111 (Sealed Beam) Head lamp Ø 111 (Sealed Beam) |  | según aplicación Some applications |
|-----------|---------|---|---|---------------------------------------|

FAROS DE TRABAJO / WORK LIGHTS

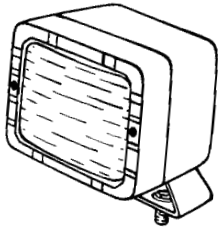

63/1931-5
(10/W.394)

Faro orientable 360°
Luz halogena H3
112 x 126mm
(Tulipa : 82 x 82mm)

*Adjustable lamp 360°
Halogen H3
112 x 126mm
(glass : 82 x 82mm)*

Bombilla / Bulbs :
63/1955-453 (12V/55W)
(10/12336)

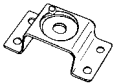

63/1934-5 Fijación 63/1931-5
(ET.131) *Bracket for 63/1931-5*

63/1931-10
(ET.1230/M)

Ø 136mm
Luz halogena H3 / Halogen H3
Con rejilla e interruptor
With grill and switch

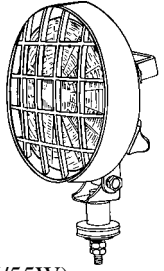

Bombilla / Bulbs : **63/1955-453** (12V/55W)
(10/12336)

63/1931-11
(ET.1162/M)

Rectangular/ Rectangular
Luz halogena H3 / Halogen H3
Con rejilla e interruptor
With grill and switch

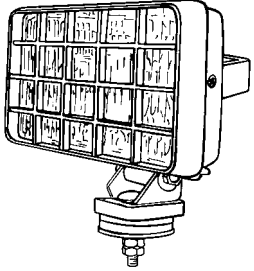

Bombilla / Bulbs : **63/1955-453** (12V/55W)
(10/12336)

Otras clases de luces se pueden encontrar en la sección de luces en la 1. parte del catálogo.
For further details, see the complete range in part 1 of the catalogue .

Las referencias originales tienen un propósito identificativo.
Nuestras piezas no son originales.

*Part numbers are quoted for reference purposes only.
Our parts and accessories are not original.*



INSTRUMENTOS (DIVERSOS)
INSTRUMENTS (MISCELLANEOUS)

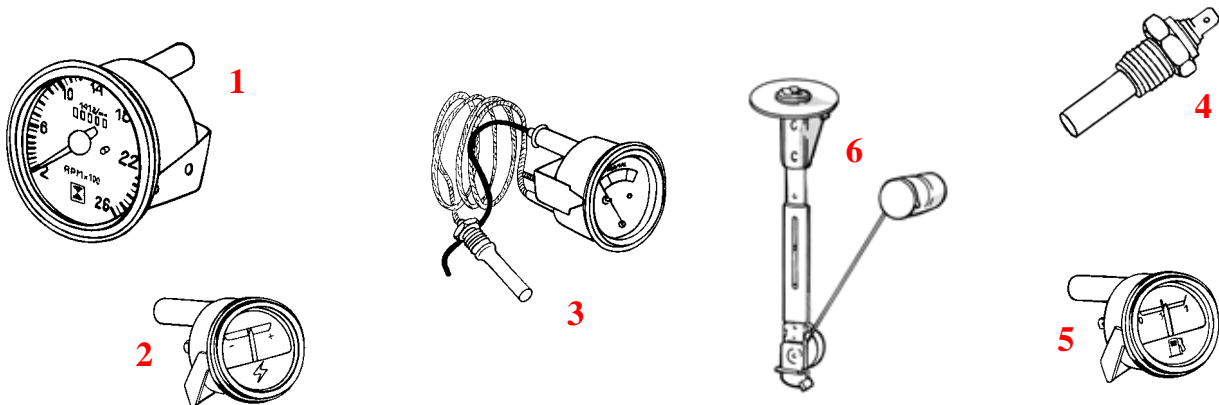

| Tractores Tractors | Fig. | Instrumentos Instruments | |
|--|------|-----------------------------|---|
| 850 ⇄ 1412, sauf série "90" except "90" serie | 1 | 20/175-80 (A) (K942227) | Cuenta-horas Hour meter |
| 25D, 30D, 900 | 2 | 20/170-80 (K19905) | Amperimetro Ammeter |
| 25D, 30D, 900, 950 | 3 | 20/174-80 (K11638) | Indicador temperatura Temp. gauge |
| 850 ⇄ 1412 | 4 | 20/180-80 (K300297) | Sensor de temperatura Temp. sender 5/8"UNF |
| 1190, 1194, 1290, 1294, 1390, 1490, 1494, 1594, 1690, 1690T | | 20/180-81 (K311943) | Sensor de temperatura Temp. sender 1/8" x 27 NPTF |
| 770 ⇄ 1412 | 5 | 20/171-80 (K917374) | Indicador combustible Fuel gauge |
| Tractores Tractors | Fig. | Flotadores Sender units | |
| 885, 990, 995, 996 | 6 | 20/172-80 (K946158) | |
| 1190, 1194, 1290, 1294, 1390, 1394 | | 20/172-81 (K309297) | Con cabina/ With cab |
| 1194, 1490, 1494, 1594, 1690 | | | Sin cabina / Less cab |
| 1190, 1290, 1294, 1390, 1394 | | 20/172-82 (K309298) | Sin cabina / Less cab |
| 1490, 1494, 1594, 1690, 1690T | | 20/172-83 (K309299) | Todos los modelos con deposito izquierdo y cabina/ All models with left side tank and cab |

(A) Sobre ciertos tractores el diametro del alojamiento del tablero debe agrandarse
(A) On some tractors, the dashboard slot diameter must be enlarged slightly.



INSTRUMENTOS (DIVERSOS)
INSTRUMENTS (MISCELLANEOUS) (CONTINUED)

| Tractores Tractors | Fig. | Manocontactos presión de aceite Pressure switches | |
|--|------|--|--|
| 850 ⇄ 1594 | 1 | 20/186-3 (K311686) | Presión aceite de motor Engine oil pressure |
| 770 ⇄ 1412 | | 20/186-80 (K921317) | Presión filtro hidráulico Hydraulic filter pressure |
| 990 ⇄ 1690 T | | 20/187-80 (K200652) | Termistor presión caja de cambio Gearbox switch |
| 885 ⇄ 1594 | | 20/962-80 (K929737) | Interruptor luz freno Stop switch |
| Tractores Tractors | Fig. | Cables de cuentahoras Drive cables | |
| 885 ⇄ 1212 Synchromatic Sin cabina / Less cab | 2 | 20/177-80 (K948533) | Tipo universal / All purpose Lg.= 1250 mm 1 tuerca/ nut 3/4" + 1 écrou/ nut 5/8" |
| 1290, 1294, 1390, 1394, 1490, 1494 Con cabina / With cab | | 20/177-18 (K957379) | Lg.= 1350 mm 1 tuerca/ nut 5/8" |
| 1594, 1690, 1690T Con cabina / With cab | | 20/177-19 (K954959) | Lg.= 1600 mm 1 tuerca/ nut 5/8" + 1 tuerca/ nut 7/8" |

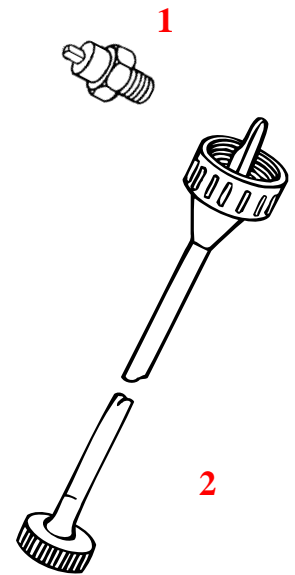

**INTERRUPTOR LUZ
LIGHT SWITCH**

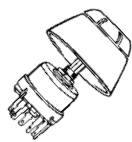

63/953-1
(K300791/2)
Interruptor luz 0-1-2-3
con accionador del claxon
Light switch 0-1-2-3
with push button horn

**INTERRUPTOR DE ARRANQUE
STARTER SWITCH**

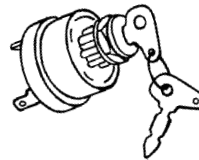

63/950-2
(K203992)
Con llave/ with keys

CABLE PARADA / STOP CABLE

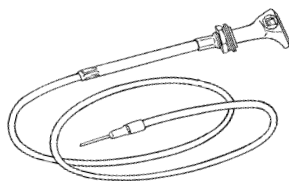

20/107-2
(R9331K)
Lg.= 1700mm

INTERRUPTOR DE ARRANQUE / STARTER BUTTON

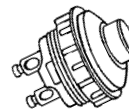

63/950-81
(K19903)

**INTERRUPTOR TIRADOR
PULL SWITCH**

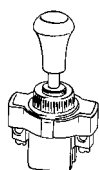

63/1882-3
(ET58)

**BOCINA
HORN**

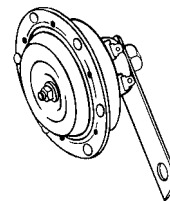

63/1995-80
(ET125)
Ø 125mm
12 volts

Para más información ver la gama completa
en la sección 1 del catálogo / For further details,
see the complete range in part 1 of the catalogue



EMBRAGUES Y DISCOS DE EMBRAGUE
CLUTCH ASSEMBLIES AND PLATES

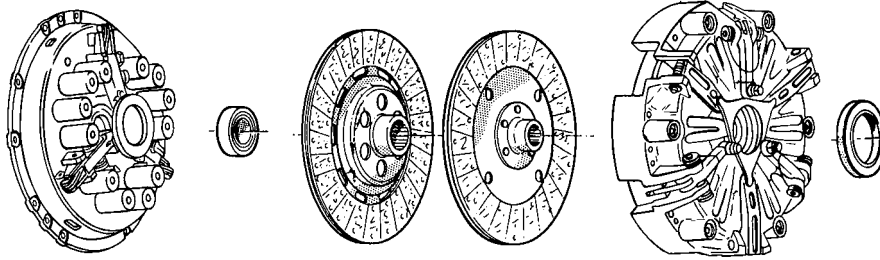

| TRACTORES TRACTORS | EMBRAGUE CLUTCH | | DISCO PLATE | | RODAMIENTO EMPUJE RELEASE BEARING |
|--|--------------------|---|--|--|--|
| | Ø | REF. no. ORDER N° | Ø | REF.no. ORDER N° | |
| 25D, 30D, 850, 900, 950 | 250 | | 250 (A) | 20/221-82 (LN) 10Z 26x32 (K14014) | 20/231-19 (K14083) Aro de carbono Carbon ring |
| 770 | 10"/10" 250/250 | 20/200-84 (K918611) B & B 3 patillas 3 levers Aro de empuje Split ring | 250 (A) 250 (A) | 20/221-84 (LN) 10Z 38x45 (K89321) 20/212-18 (LM) 10Z 18x22,5 (K910886) | 20/231-20 52,3x85,7x19 (K620182) 20/230-10 (RV) 22,2x50,8x14,2 (K19167) |
| 775, 780, 880, 885, 950, 1194 | 10"/10" 250/250 | 20/200-84 (K918611) B & B 3 patillas 3 levers Aro de empuje Split ring | 250 (A) 250 (A) | 20/221-84 (LN) 10Z 38x45 (K89321) 20/212-19 (LM) 10Z 23x29 (K89322) | 20/231-21 69,8x103,2x22,8 (K19169) 20/230-10 (RV) 22,2x50,8x14,2 (K19167) 20/231-80 63,9x103,2x22,8 (K620085) (880 Select.) LAYCOCK |
| 900, 990, 995 | 11"/10" 280/250 | 20/200-86 (K957252) B & B 3 patillas 3 levers Aro de empuje Split ring | 280 (A) 250 (A) | 20/221-86 (LN) 10Z 38x45 (K957254) 20/212-19 (LM) 10Z 23x29 (K89322) | 20/231-21 69,8x103,2x22,8 (K19169) 20/230-10 (RV) 22,2x50,8x14,2 (K19167) |
| 996, 1190 (⇄ 1979), 1200, 1210 (⇄ 1154230), 1212, 1290, 1294 (⇄ 11059299), 1390 Tipo/ Types HYDRASHIFT 996, 1200, 1210, 1212, 1190, 1290, 1390 | 11"/11" 280/280 | (228 0087 10) 20/200-87 (K957435) 6 patillas 6 levers 2 aros de empuje 2 split rings | 280 (A) 280 (A) 280 (A) | 20/221-86 (LG) 10Z 38x45 (K957254) Grosor cubo rueda : 31mm Hub thickness : 31mm (Std) 20/212-20 (LM) 10Z 23x29 (K915827) (Std + Hydrashift) 20/221-87 (LG) 10Z 38x45 (K957436) Grosor cubo rueda : 38mm Hub thickness : 38mm (Hydrashift) | 20/231-21 69,8x103,2x22,8 (K19169) 20/231-22 76x114,5x19 (K19177) 20/230-10 (RV) 22,2x50,8x14,2 (K19167) |

Las referencias originales tienen un propósito identificativo.
Nuestras piezas no son originales.

Part numbers are quoted for reference purposes only.
Our parts and accessories are not original.



| TRACTORES TRACTORS | EMBRAGUE CLUTCH | | DISCO PLATE | | RODAMIENTO EMPUJE RELEASE BEARING |
|---|--------------------|--|----------------|--|---|
| | Ø | REF. no. ORDER N° | Ø | REF. no. ORDER N° | |
| 1190, 1194 (80 /-) 1210 (1154231⇨) 1294 (11059300 ⇨) 1394, 1410, 1412, 1490, 1494 | 12"/12" 305/305 | 20/200-88 (K202291) 6 patillas 6 levers LAYCOCK | 305 (A) | 20/221-88 (LG) 10Z 38 x 45 (K202625) | 20/231-21 69,8x103,2x22,8 (K19169) 20/231-22 76x114,5x19 (K19177) 20/230-10 (RV) 22,2x50,8x14,2 (K19167) |
| 1210, 1410, 1412, 1490, 1494 4RM/WD | 12"/12" 305/305 | 20/200-89 (K956051) 6 patillas 6 levers LAYCOCK | 305 (B) | 20/221-89 (LG) 10Z 38 x 45 (K956052) Revestimiento cerametalico Cera metallic linings | |
| 1590, 1594, 1690, 1694 | 12"/12" 305/305 | 20/200-90 (K202825) 6 patillas 6 levers LAYCOCK | 305 (B) | 20/221-90 (LG) 17Z 41 x 46 (K202826) | |
| | | | 305 (A) | 20/212-21 (LM) 10Z 23 x29 (K947089) | |
| | | | 305 (A) | 20/212-22 (LM) 10Z 26 x32 (K952378) | |

(Z) Dientes
 (A) Revestimiento orgánico sin amianto
 (B) Revestimiento cerametalico
 (LG) Disco principal, transmisiòn lateral montada
 (LN) Disco principal, lado motor libre
 (LM) Disco TdF, motor lateral, suelta
 (RV) Cojinete

(Z) Teeth
 (A) Asbestos free organic lining
 (B) Cerametallic lining
 (LG) Main disc, transmission side, mounted
 (LN) Main disc, engine side, loose
 (LM) PTO disc, engine side, loose
 (RV) Pilot bearing

CILINDRO PRINCIPAL Y RECEPTOR (EMBRAGUE) MASTER & SLAVE CYLINDERS (CLUTCHES)

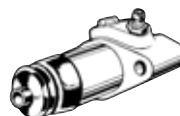
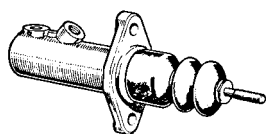

| Tractores Tractors | Cil. principal Master cyl. | Juego de reparación Repair kit | Cil. receptor Slave cyl. | Juego de reparación Repair kit |
|--|-------------------------------|-----------------------------------|-------------------------------|-----------------------------------|
| 990, 995, 996, 1210, 1212, 1690 (Con & sin cabina/ With or less cab) | 20/226-80 (K950544) | 20/227-80 (K964572) | 20/228-80 (K952267) | 20/229-80 (K964573) |
| 996 | | | | 20/229-81 (K964576) |
| 1190, 1290, 1390, 1490, 1690 (Sin cabina / less cab) | | | 20/228-82 (K203416) | 20/229-82 (K965723) |
| 1410, 1412, 1494, 1594, 1694, 1694T | | | 20/228-83 (K200219) | 20/229-83 (K965765) |

Las referencias originales tienen un propósito identificativo.
 Nuestras piezas no son originales.

Part numbers are quoted for reference purposes only.
 Our parts and accessories are not original.



FRENO (DISCO, TAMBOR)
BRAKES-DISC & DRUM

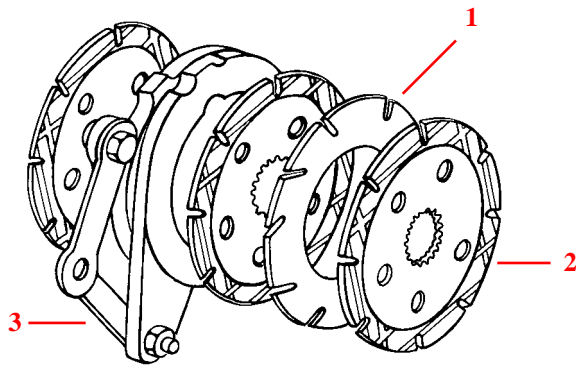

Muelle/ Spring
20/419-80
(K963644)



Bola/ Ball
20/418-80
(K963645)



| Fig. | | 1 | 2 | 3 |
|------------------------------------|----------------|-------------------------------|-----------------------------------|--|
| Tractores Tractors | Freno Brake | Disco Inter. disc | Plancha de freno Friction disc | Cojunto de freno Actuator assy. |
| 1490, 1690 2RM/ 2WD | Ø 178mm | 20/423-80 (K200550) | 20/422-80 (K202905) | 20/417-80 (K954738) |
| 1410, 1412, 1690, 1494, 1594, 1694 | Ø 222mm | 20/423-81 (K945755) | 20/422-81 (K945754) | 20/417-81 (K945753) (Stock end) |

JUEGO DE ZAPATAS CON REMACHES
4 BRAKE LININGS SET WITH RIVETS

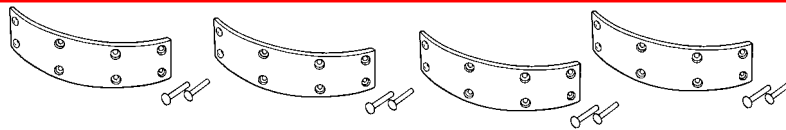

| | | |
|---------------------------------------|--------------------------------|--|
| 770, 850, 885, 95, 990 | 20/404-80K (K960595) | Ancho/ Width 44mm |
| 990, 995, 996, 1190, 1194, 1290, 1390 | 20/404-81K (K962266) | Ancho/ Width 63mm |
| 1200, 1210, 1212, 1390, 1490 | 20/404-82K (K964542) | Ancho/ Width 89mm 3 líneas de remaches 3 rows rivets |

RETEN
OIL SEAL

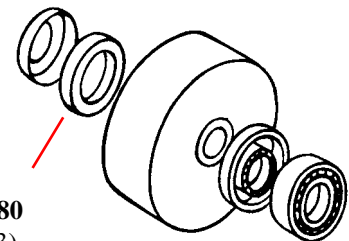

20/402-80
(K13353)
81 x 44,4 x 12,7mm

Modelos antiguos / Older tractors

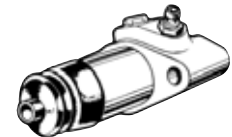

CILINDRO PRINCIPAL Y RECEPTOR (FRENO)
MASTER & SLAVE BRAKE CYLINDERS

| Tractores Tractors | Cilindro principal Master cyl. | Juego de reparación Repair kit | Cilindro receptor Slave cyl. | Juego de reparación Repair kit |
|---------------------------------------|-----------------------------------|-----------------------------------|---------------------------------|-----------------------------------|
| 990, 995, 996, 1210, 1212, 1410, 1412 | 20/226-80 (K950544) | 20/227-80 (K964572) | | 20/229-80 (K964573) |
| 1190, 1290, 1390 | | | 20/228-82 (K203416) | 20/229-82 (K965723) |
| 1490, 1494, 1594, 1690, 1694, 1694T | | | 20/228-83 (K200219) | 20/229-83 (K965765) |

Las referencias originales tienen un propósito identificativo.
Nuestras piezas no son originales.

Part numbers are quoted for reference purposes only.
Our parts and accessories are not original.



PIEZAS PARA EL EJE DELANTERO
FRONT AXLE PARTS

JUEGO DE REPARACIÓN
REPAIR KIT

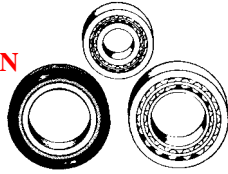

(1 rueda / 1 wheel)

| Tractores Tractors | Ref. de juego Kit ref. | Kit compuesto de Kit composition |
|--|-------------------------------|---|
| 770, 780 | 20/460-10 (K962984) | 1 x K24659 (2) 1 x K620076 (3) 1 x K623450 (6) |
| 850, 880, 885, 950, 990, 995, 996 | 20/460-11 (K962985) | 1 x K623450 (6) 2 x K620046 (2-3) |
| 1200, 1210, 1212, 1410, 1412, 1490, 1690, 1494, 1594 | 20/460-12 (K962986) | 1 x K623419 (6) 1 x K19186 (3) 1 x K19085 (2) |
| 885, 995, 996, 1190, 1194, 1290, 1294, 1390, 1394 | 20/460-81 (K262214) | 1 x K623450 (6) 1 x K620046 (Ø 35) (2) 1 x K620167 (Ø 38) (3) |

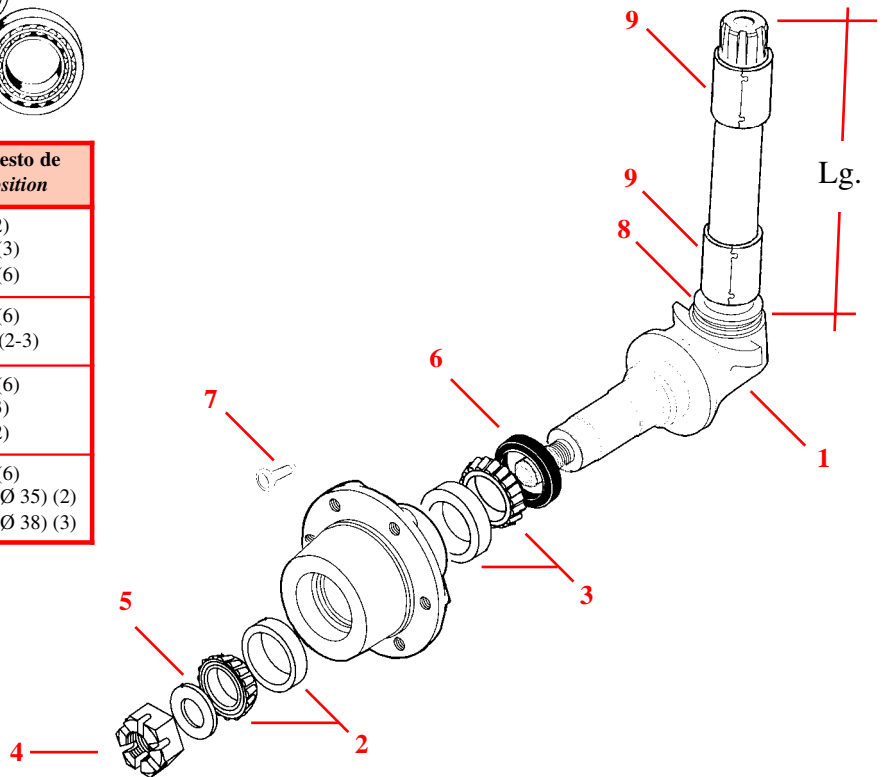

| Fig. | 1 | 2 | 3 | 4 | 5 | 6 | 7 | 8 | 9 | |
|---|--|---------------------------------------|---------------------------------------|---------------------------------------|-------------------------------|-------------------------------|--|------------------------------|------------------------------|------------------------------|
| Tractores Tractors | Mangueta Spindle | Rodamiento Bearing | | Tuerca Nut | Arandela Washer | Retén Seal | Tornillo Screw | Juntas tórica O'Ring | Rodamiento Bearing | Casquillo Bush |
| 25D, 30D, 900, 950 IMPLEMATIC, 850R | | 20/462-26 (K32676) | | | | | | | | |
| 770, 780 SELECT. | | 20/463-10 (K24659) | 20/462-10 (K620076) | | | | | | | |
| 880, 990, 1390, 995, 996 (⇔ 11.070.001) | 20/470-80 (K961725) Lg. = 254 mm (A) (B) | | 20/462-11 (K620046) Ø 35 | | | | | | | |
| 885, 995, 996 (11.070.002 ⇔), 1190, 1290, 1294, 1390, 1394 Despeje bajo Low clearance | 20/470-72 (K262209) Lg. = 254 mm (A) | 20/462-11 (K620046) Ø 35 | | 20/452-80 (K617157) 3/4" | 20/451-80 (K626673) | 20/461-10 (K623450) | 770 ⇔ 1390 20/446-80 (K907400) 1/2" UNC | 20/476-80 (K15594) | 20/479-80 (K33682) | 20/477-80 (K11598) |
| 1290, 1294, 1390, 1394 **Haut dégagement** High clearance | 20/470-73 (K262211) Lg.= 460 mm (A) | | 20/462-25 (K620167) Ø 38 | | | | | | | |
| 1190, 1194 | 20/470-74 (K262207) Lg. = 184 mm (A) | | | | | | | | | |
| 1200, 1210, 1212, 1410, 1412, 1490, 1690 | | 20/463-12 (K19085) | 20/462-12 (K19186) | | | 20/461-12 (K623419) | 20/446-81 (K600875) | | | |

(A) Ambos lados / Right or left

(B) Servida con tuerca 7/8" / Supplied with 7/8" nut

Las referencias originales tienen un propósito identificativo.
Nuestras piezas no son originales.

Part numbers are quoted for reference purposes only.
Our parts and accessories are not original.



**TRANSMISIÓN «HYDRASHIFT»
«HYDRASHIFT» TRANSMISSION**

20/680-80
(K203026)

Pistón (válvula de control)
Piston (control valve)

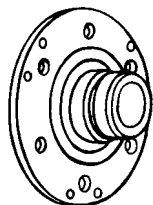
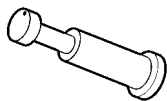

20/377-81 Buje de Rueda/ Hub
(K207666)
De centro a centro agujero 146,05 mm
Fitting center to fitting center 146,05 mm

**JUEGO DE REPARACIÓN
PARA LA ROSCA DE LA MANGUETA
FRONT SPINDLE THREAD REPAIR KIT**

70/457-2
(LN.10-2)

Rosca 3/4" UNF
Thread 3/4" UNF

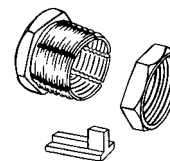

70/457-5
(LN.10-5)

Rosca 7/8" UNF
Thread 7/8" UNF

La tuerca interior cónica se cola sobre la rosca deteriorada y se cierra con la rosca exterior.

The inner nut is screwed on the worn thread and is locked by the outer nut.

**POLEA CON CORREA PLANA
FLAT BELT PULLEY**

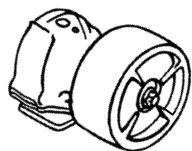

Para David Brown, Modelos antiguos
For David Brown, old range

20/6300-80
(20/V.440)

Adaptable a la t.d.f.
Adaptable to the rear power take off.
Fijación con 4 tornillos / *Fitting 4 studs.*
Sentido de rotación reversible/ *Reversible rotation direction*

**CRUCETAS PARA EJE DELANTERO "CARRARO"
"CARRARO" FRONT AXLE UNIVERSAL JOINT**

20/6403-80
(K965331)
20/6403-81
(K262161)
20/6403-20
(K965215)

(Ø 27 x 82 mm)
(Ø 27 x 74,6mm)
(Ø 30 x x79,2mm)
990, 995, 996, 1290, 1390, 1490

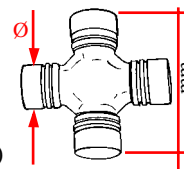

LLANTAS / RIMS

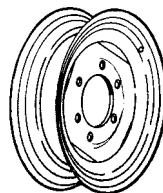

20/449-11 (4.50" x 16")
(K947937)
20/449-80 (4.50" x 19")
(K947940)
20/449-12 (5.50" x 16")
(K947941)
20/449-13 (5.50" x 18")
(K949731)

**EJE TOMA DE FUERZA REVERSIBLE
REVERSIBLE POWER TAKE OFF SHAFT**

20/303-80
(K948393)

1410, 1412, 1590, 1594,
1690, 1694

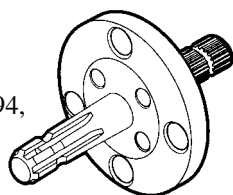

13/8"
6 dientes/ 6 teeth

13/8"
21 dientes
21 teeth

**TORNILLO PARA LLANTA (RUEDA TRASERA)
BOLT (REAR WHEEL)**

3" x 5/8" UNF

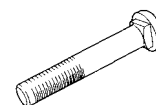
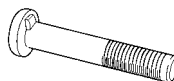

20/442-2 Con chaveta/ *With lug*
(K611261)
20/442-3 Con cuadro/ *With square*
(K611270)
20/443-3 Tuerca/ *Nut*
(K617006)

**EJE DE DIRECCIÓN
STEERING SHAFT**

20/530-80
(K912411)

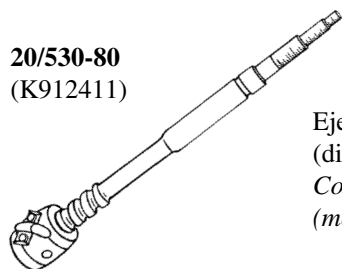

Eje completo
(dirección manual)
Complete shaft with nut
(mechanical steering)

880 Selectamatic, 990 Selectamatic, 990 Synchronomatic,
995, 996

VOLANTE/ STEERING WHEEL

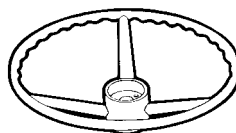

20/510-80
(K83746)

770, 780, 850, 880, 885, 990, 995, 996, 1200, 1210, 1212

Las referencias originales tienen un propósito identificativo.
Nuestras piezas no son originales.

Part numbers are quoted for reference purposes only.
Our parts and accessories are not original.



RÓTULAS DE DIRECCIÓN
TIE RODS

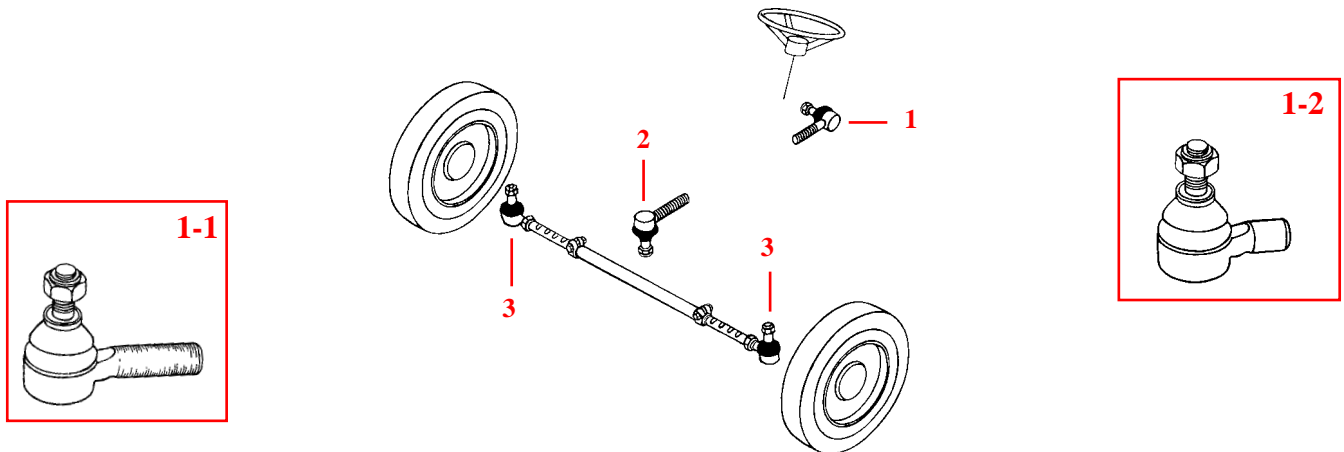

| Tractores Tractors | | 1 | | 2 | | 3 | |
|---|--|---|---|---|---|---|--|
| 770, 780, 850, 880, 885, 950, 990, 995, 996 (⇔ 11075111) | Dirección manual | 20/491-80 (K908071) 1-1 | Rosca/Thread 3/4" Cono/ Cone 5/8" x 11/16" | 20/491-80 (K908071) 1-1 | Rosca/Thread 3/4" Cono/ Cone 5/8" x 11/16" | 20/491-80 (K908071) 1-1 | |
| 990, 995, 996 (11075112 ⇔) | Mechanical steering | 20/491-81 (K207722) 1-1 | Rosca/Thread 3/4" Cono/ Cone 3/4" x 13/16" Lg.=100mm | 20/491-81 (K207722) 1-1 | Rosca/Thread 3/4" Cono/ Cone 3/4" x 13/16" Lg.=100mm | 20/491-81 (K207722) 1-1 | |
| 770, 780, 880, 885, 950 | Dirección asistida Power steering | 20/491-80 (K908071) 1-1 | Rosca/Thread 3/4" Cono/ Cone 5/8" x 11/16" | | | 20/491-80 (K908071) 1-1 | |
| 1200 | | 20/491-81 (K207722) 1-1 | Rosca/Thread 3/4" Cono/ Cone 3/4" x 13/16" | | | | |
| 885, 990, 995, 996, 1210, 1212 (Avec vérin latéral With lateral cyl.) | | 20/581-82 (K207721) 1-1 | Rosca/Thread 3/4" Cono/ Cone 3/4" x 13/16" Lg.=70mm | 20/581-83 (K929057) 1-2 | Rosca/Thread 7/8" Cono/ Cone 3/4" x 13/16" | | |
| 1290, 1390, 1490 | Eje "Carraro" "Carraro" Front axle | | | | | 20/496-80 (K965270, 98854) Izq./ LH | 20/495-80 (K965269, 98855) Dcha./ RH |
| 1494, 1594, 1690 | | | | | | 20/496-81 (K260254) Dcha./ RH | 20/495-81 (K260250) Izq./ LH |

| Tractores Tractors | | 1 | 2 |
|--|--------------------------------------|---|---|
| 1190, 1194, 1210, 1212, 1290, 1294, 1390, 1394, 1410, 1412, 1490, 1494, 1594, 1690 | Dirección asistida Power steering | 20/581-82 (K207721) 1-1 | 20/491-80 (K908071) 1-1 |
| 1494, 1594 | | | 20/491-81 (K207722) 1-1 |

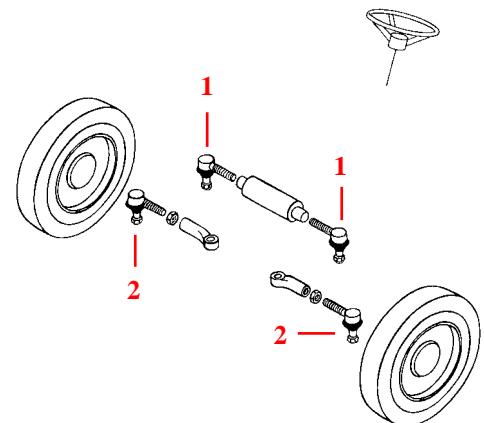

Las referencias originales tienen un propósito identificativo.
Nuestras piezas no son originales.

Part numbers are quoted for reference purposes only.
Our parts and accessories are not original.



BOMBAS HIDRÁULICAS
HYDRAULIC PUMPS

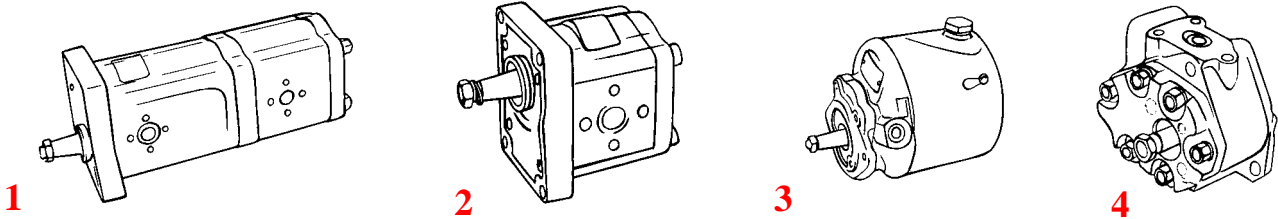

| Fig. | 1 | 2 | 3 | 4 |
|--|--|--|---|--------------------------------|
| Tractores Tractors | Bomba doble Tandem pump | Bomba simple Single pump | Bomba de dirección Steering pump | Bomba interna Internal pump |
| 880, 885, 990, 995, 996, 1190, 1194, 1290, 1294, 770, 780 Select | | | | 20/640-206 (K962635) |
| 1200, 1210, 1212 | | 20/640-207 (K919048) 11cm ³ | | |
| 1390, 1394, 1410, 1412, 1490, 1494 | | 20/640-208 (K.307945) 15cm ³ | | |
| 1594, 1690, 1690T, 1694 | | 20/640-209 (K949605) 19cm ³ | | |
| 1200, 1210, 1212, 1390, 1394, 1410, 1412, 1490, 1494 | 20/640-210 (K916535) 15 + 11cm ³ | | | |
| 1594, 1690, 1690T, 1694 | 20/640-211 (K310386) 19 + 14cm ³ | | | |
| 990, 995, 996, 1210, 1212, 1290, 1294, 1390, 1394, 1410, 1412, 1490 | | | 20/570-206 (K957318) 10cm ³ (A) (B) | |

(A) Juego de reparación / *Repair kit* : **20/575-206** (K964935)

(B) Filtro int. de depósito / *Inner filter for tank* : **20/574-16** (K964954)

FILTROS DE DIRECCIÓN ASISTIDA
POWER STEERING FILTERS

Según el montaje/ *Depends fittings*



20/574-15 Ø 85mm
(K960750)
20/574-16 Ø 100mm
(K964954)

VALVULA HIDRÁULICA
HYDRAULIC SPOOL VALVE

20/7613-1
(H13066)

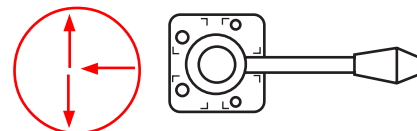

Valvula hidráulica con 2 direcciones (Para adaptar)
2 ways spool hydraulic valve (to adapt)

Para más información ver la gama completa en la
sección 1 del catálogo / *For further details,*
see the complete range in part 1 of the catalogue



CONEXIONES DE LA BOMBA HIDRAÚLICA
HYDRAULIC PUMP DRIVE

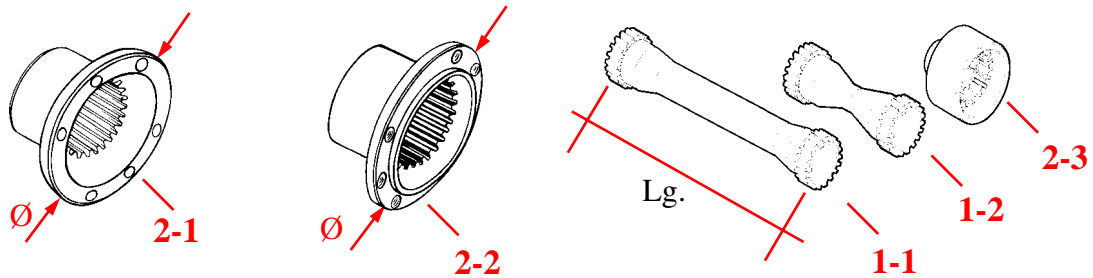

| Fig. | 1 | | 2 | |
|---|--|-----------|--|---------------------------------------|
| Tractores Tractors | Eje Shaft | | Acoplamiento Coupling | |
| 1200 (2 montaje / 2nd version), 1210, 1212, 1394, 1410, 1412, 1490, 1494 | 20/660-2 (K944950) 1-1 | Lg.=235mm | 20/662-2 (K910538) 2-1 | Sin pestaña Less flange Ø 112mm |
| 1590, 1594, 1690, 1694 sin aire acondicionado less air conditionning | 20/660-3 (K200464) 1-2 | Lg.=120mm | 20/662-3 (K200465) 2-2 | Con pestaña With flange Ø 107mm |
| 1490, 1494, 1590, 1594, 1690, 1694 | | | 20/663-3 (K944947) 2-3 | Lg.=46mm |

JUEGOS DE DIRECCIÓN ASISTIDA
POWER STEERING KITS

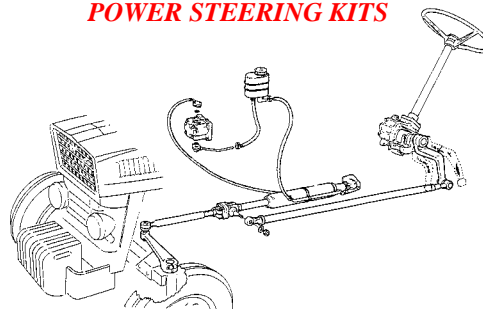

- 20/6500-99** - David Brown 990, 995 (DA099)
- 20/6500-98** - David Brown 1200 (DA098)
- 20/6500-100** - David Brown 1210 (DA100)
- 20/6500-101** - David Brown 1290 (DA101)

Estos juegos están equipados con todas las piezas necesarias para la instalación

*These kits are supplied with all parts needed for installation.
Availability on receipt of firm order.*



CAJA NIVELADORA, ESTABILIZADORES Y ACCESORIOS
LEVELLING BOX ASSEMBLY, STABILISERS & ACCESSORIES

ESTABILIZADORES
STABILISER

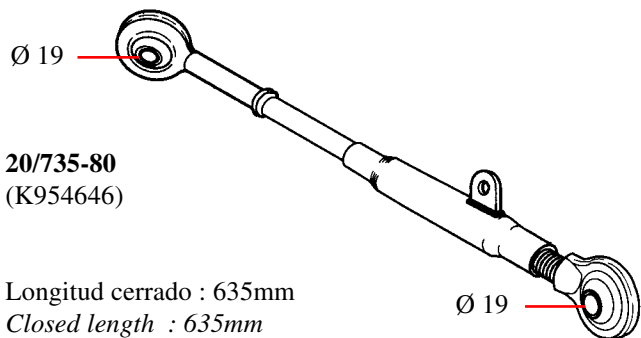

20/735-80
(K954646)

Longitud cerrado : 635mm
Closed length : 635mm

Series 1200, 1210, 1212, 1394, 1410, 1412, 1490, 1494
1200, 1210, 1212, 1394, 1410, 1412, 1490, 1494 series

Bulones de estabilizador / Stabiliser pins

- | | |
|-------------------------------|--------------------|
| 20/730-81 (K907008) | 850, 880, 950, 990 |
| 20/730-80 (K912228) | 780, 885 |



Estabilizadores de cadena
ver nuestra gama completa en el capítulo 1.
Stabiliser chain, see the full range on catalogue part 1.



ESTABILIZADORES RÍGIDOS Y AJUSTABLES
RIGID & ADJUSTABLE STABILISERS

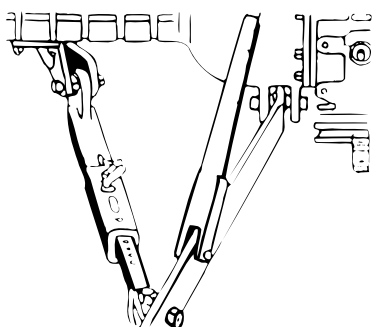

Dos estabilizadores con soportes a ambos lados
2 rods + left and right brackets

- | | |
|--------------------------------|--|
| 20/740-80K (DB169K2) | 850, 880, 900, 950 |
| 20/740-81K (DB170K2) | 990, 995, 996 y derivados/ and related models |

Las referencias originales tienen un propósito identificativo.
Nuestras piezas no son originales.

EJES Y CASQUILLOS (BRAZO DEL LEVANTE)
PINS AND RINGS (LIFT ARMS)

20/710-80
(K900054)

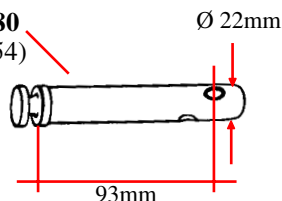

20/719-80
(K900055)
28,6x22mm



Bulòn 3er punto / Top link pins

- | | | |
|--------------------|------|------------|
| 68/1138-70 | Ø 19 | Lg.= 77mm |
| 68/1138-95 | Ø 19 | Lg.= 103mm |
| 68/1142-103 | Ø 25 | Lg.= 110mm |

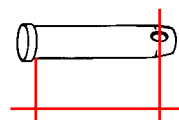

Bulòn 22/28 del brazo al puente trasero
Link arm 22/28 fitting to rear axle

- | | | |
|-------------------------------|------------------|--------------|
| 20/710-81 (K922634) | Ø 22mm Ø 28mm | 990/995, ... |
|-------------------------------|------------------|--------------|

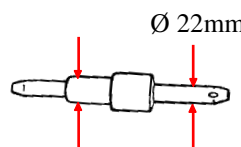

HORQUILLA NIVELADORA
LEVELLING BOX ASSEMBLY

Series 800, 900, 1200
800, 900, 1200 series

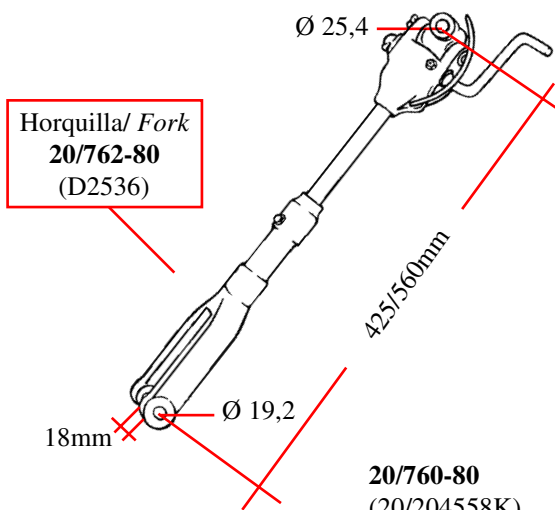

Horquilla/ Fork
20/762-80
(D2536)

20/760-80
(20/204558K)

Caja niveladora
Levelling box assembly

Part numbers are quoted for reference purposes only.
Our parts and accessories are not original.



ALTERNADORES Y GENERADORES
ALTERNATORS & DYNAMOS

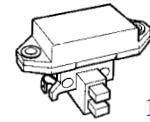
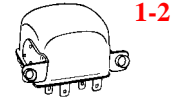
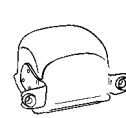
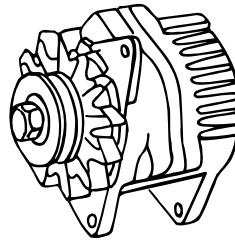
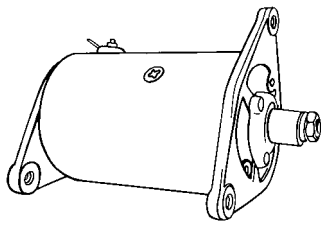

| Tractores Tractors | Alternador Alternator | Capacidad Capacity | Comentario Comment | OEM | Regulador Control box | Fig. |
|---|--|------------------------------------|---|-----------------|--|------------------------------|
| 770, 780, 880, 990, 1200 | 62/910-1 (22703) (Generador Dynamo) | 12V., 11 Amp. | Generador tipo LUCAS | K908882 | 62/919-1 (↔ 65) (K900136) 62/919-2 (65 ↔) (K908901) | 1-1 1-2 |
| 885, 990, 995, 996, 1210, 1212, 1410, 1412 | 62/920-59 (15/1067) 62/920-87 (510E344) | 14V., 33 Amp. 14V., 45 Amp. | Eje/ Shaft Ø 17mm EjeØ 15mm VALEO Shaft Ø 15 mm VALEO | 92293C1 | 62/919-17 (205/04034) 62/919-22 (505E032) | 1-3 |
| 1190, 1290, 1390, 1490, 1690 (↔ 5/81 Montaje izq. / Left fitting) | 62/920-24 (15/1305) (W) 62/920-26 (510E343) | 14V., 55 Amp. 14V., 45 Amp. | VALEO | K306549 | 62/919-17 (205/04034) 62/919-22 (505E032) | 1-3 |
| 1190, 1290, 1390, 1490, 1690 (6/81↔ Montaje drcha. / Right fitting) | 62/920-27 (510E324) 62/920-4 (15/1068) (W) | 14V., 45 Amp. 14V., 55 Amp. | VALEO | K956426 | 62/919-22 (505E032) 62/919-17 (205/04034) | 1-3 |
| 1194, 1294, 1394, 1494, 1594, 1694 | 62/920-4 (15/1068) (W) | 14V., 55 Amp. | Corea/ Belt 9,5 mm | | 62/919-17 (205/04034) | 1-3 |
| 1194, 1294, 1394, 1494, 1594, 1694 con airco with air conditioning | 62/920-10 (15/1276) (W) | 14V., 65 Amp. | Corea/ Belt 12,5 mm | K302424 | 62/919-17 (205/04034) | 1-3 |

(W) Conexión eléctrica / Electrical connection

REPUESTOS PARA GENERADORES Y ALTERNADORES «LUCAS»
MISCELLANEOUS PARTS FOR «LUCAS» DYNAMO & ALTERNATOR

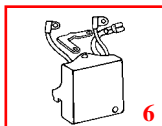
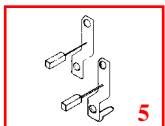
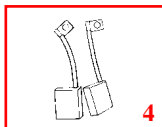
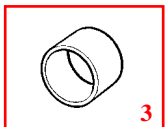
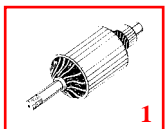

- | | | |
|---|--|--|
| <ol style="list-style-type: none"> 1. 62/911-2 (UWB102) 2. 62/915-1 (UTB107) 3. 62/914-1 (UTB110) 4. 62/913-2 (USB104) 5. 62/923-1 (ULB110) 6. 62/919-80 (UCB100) 62/919-81 (UCB109) | <p>Inducido Armature</p> <p>Rodamiento Ball bearing</p> <p>Cojinete Bush</p> <p>Juego de escobillas Brush set</p> <p>Juego de escobillas para alternador "LUCAS" Brush set for "LUCAS" alternators</p> <p>Regulador para alternador "LUCAS" 34A Control box for "LUCAS" 34 A alternators</p> <p>Regulador para alternador "LUCAS" 55A Control box for "LUCAS" 55 A alternators</p> | <p>para generador tipo C.40 for dynamo C.40 type</p> |
|---|--|--|

Las referencias originales tienen un propósito identificativo.
Nuestras piezas no son originales.

Part numbers are quoted for reference purposes only.
Our parts and accessories are not original.



**MOTORES DE ARRANQUE
STARTER MOTORS**

Lanceur : 11Z = 11 dientes
Fixation : Número de agujeros
R : Montaje dcha.
L : Montaje izq.

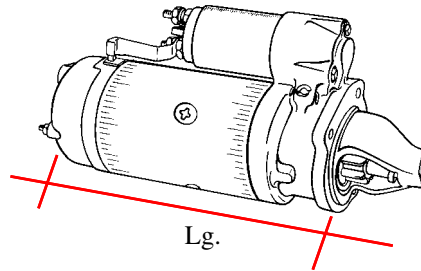

Drive : 11Z = 11 teeth
Fitting : Numbers of holes
R : right side mounting
L : left side mounting

| Tactores Tractors | Ref. Ref. | Transmisión Drive ass. | Fijación Fitting | Lg. sobresaliente Prominent length | Capacidad Capacity | OEM |
|--|------------------|---------------------------|---------------------|---------------------------------------|-----------------------|--------------------|
| 770, 780, 880, 885, 990 (blanco/ white), 1190, 1194 (69-71) | 62/930-6 | 11Z | 3L | Lg. 230mm | 12V., 2,8 KW | K957341 K913007 |
| 850, 950, 990 (rojo/ red), 995, 996, 1200, 1210, 1212, 1290, 1294, 1390, 1394, 1410, 1412, 1490, 1494 (80-83) | 62/930-3 | 11Z | 3R | Lg. 224mm | 12V., 2,8 KW | K957340 |
| 1594, 1690, 1694 (84-) | 62/930-15 | 10Z | 3R | Lg. 245mm | 12V., 2,8 KW | K308650 |

**REPUESTOS PARA MOTORES DE ARRANQUE ORIGINAL
SPARE PARTS FOR GENUINE STARTER MOTORS**







| Fig. | Motor de arranque Starter motors | 1 | 2 | 3 | 4 | 5 | 6 |
|---|--|--|---|---|--|--|---|
| Tractores Tractors | | Inducido Armature | Inductor Field coils | Juego de escobillas Brush set | Transmisión Drive assy. | Automatico Solenoid | Juego de 3 cojines 3 bearings set |
| 770, 780, 885, 990, 995, 996, 1190, 1194, 1200, 1210, 1212, 1290, 1294, 1390, 1394, 1410, 1412, 1490, 1494, 1594, 1690, 1694 | M.45G (26278, 27413) LRS.157 K.957340 | 62/931-4 3 can./ spl. (TIB114) | 62/932-3 (TEB132, A48238) | 62/933-2 (TAB125, K962799) | 62/939-36 3 can./ spl. (TMB107) | 62/940-7 (TOB162, K963825) | 62/934-1 (TCB118, K963791, K963931) |
| | 2M113 (27421) LRS.166 K.957341) | 62/931-5 12 can./ spl. (TIB108, K964185) | 62/932-4 (TEB129, K964210) | 62/933-3 (TAB118, K964218) | 62/939-9 12 can./ spl. (TMB124, K964242) | | |
| 850, 880, 950, 990 Rojo/ Red | M.45G (26133) | 62/931-3 (TIB113) | 62/932-3 (TEB132, A48238) | 62/933-2 (TAB125, K962799) | 62/939-3 (TLB117) | 62/940-5 (TOB153) | |
| 1394, 1410, 1412, 1490, 1494, 1594, 1690, 1694 | M.50G (26379 K.919752) | 62/931-7 (TJB103, K964221) | 62/932-4 (TEB129, K964210) | 62/933-3 (TAB118, K964218) | 62/939-11 (TMB115, K964214) | 62/940-9 (TOB110, K964215) | |
| | M.127/2,8 (27528 LRS.552 K.308650) | 62/931-9 (TJB114, K262025) | 62/932-7 (TEB144, K262024) | | 62/939-14 (TMB148, K262028) | 62/940-12 (TPB111, K262026) | |

Las referencias originales tienen un propósito identificativo.
Nuestras piezas no son originales.

Part numbers are quoted for reference purposes only.
Our parts and accessories are not original.

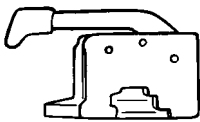
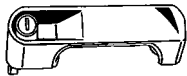

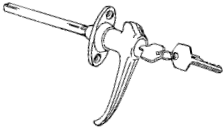
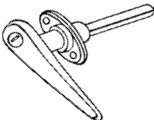
MANETA DE LA PUERTA
CAB DOOR LOCKS & HANDLES

| | | | |
|---|----------------------------------|-------------------------|--|
|  | 70/4170-19 (K303805) | Izq./ LH | Series 1190 ⇄ 1694 Series |
| | 70/4170-20 (K303806) | Drcha./ RH | Series 1190 ⇄ 1694 Series |
|  | 70/4170-21 (K303755) | Exterior/ Outer | Series 1190 ⇄ 1694 Series |
|  | 70/4170-25 (K260004) | Exterior/ Outer | 885 (Cabina LP)/ (LP cab) |
|  | 70/4170-84 (K955435) | Exterior/ Outer | 885, 990, 995, 996, 1210, 1212, 1410, 1412 |
|  | 70/4170-85 (K773205/6) | Izq. o Drcha./ LH or RH | 885, 990, 995, 996, 1210, 1212 1410, 1412 |
|  | 70/4170-86 (K955448) | Interior/ Inner | 885, 990, 995, 996, 1210, 1212 1410, 1412 |

PINTURA / PAINT

LA MEJOR
PINTURA

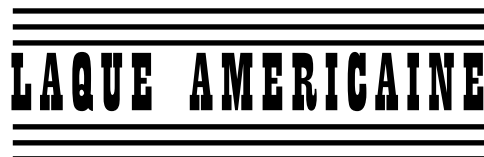

THE BEST PAINT
ON THE MARKET

64/LA.9002/L Marfil / Ivory (1 litro / 1 liter)

64/LA.9002/SP Marfil / Ivory (Spray)



PINTURA DE CALIDAD A UN PRECIO ATRACTIVO
QUALITY PAINT AT AN ATTRACTIVE PRICE



64/3102-42
Marrón / Chocolate brown
(1 litro / 1 liter)

64/3102-30
Marfil / Ivory
(1 litro / 1 liter)

Para otros detalles ver nuestra gama completa en el capítulo 1 del catálogo. / For further details, see the complete range in part 1 of the catalogue.



Las referencias originales tienen un propósito identificativo.
Nuestras piezas no son originales.

Part numbers are quoted for reference purposes only.
Our parts and accessories are not original.



JUEGO CALCOMANÍAS DECAL SETS

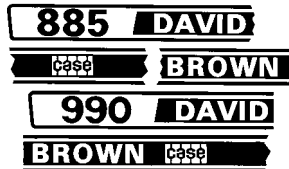
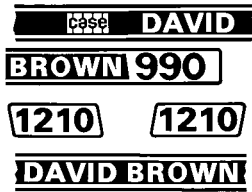

Se incluyen adhesivos laterales dcha. y izq.
Left and right set for one tractor

| | |
|------------------------|-------------------|
| 20/860-80 (K962479) | 880 SELECTAMATIC |
| 20/860-81 (K947732) | 885 SYNCHROMATIC |
| 20/860-82 (K949207) | 990 SYNCHROMATIC |
| 20/860-83 (K949208) | 995 SYNCHROMATIC |
| 20/860-84 (K949210) | 1210 SYNCHROMATIC |
| 20/860-85 (K962148/53) | 1200 SELECTAMATIC |

ASIENTO / SEATS

ASIENTO COMPLETO / COMPLETE SEAT



61/830-865
(SG10/UN)

- * Acabado en plástico negro
- * Suspensión vertical con amortiguador hidráulico
- * Asiento con guías de ajuste
- * Base inclinada y regulable de 12 a 20° (5 posiciones)

- * *Black upholstery*
- * *Height adjustment with hydraulic damper*
- * *Sliderails for horizontal adjustment*
- * *Horizontal mounting plate with adjustment 5 positions (12° --> 20°)*

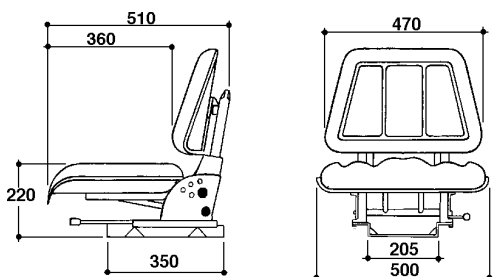

Ver nuestro gama completa de asientos en el fascículo del catálogo general. / *For further, see the complete range in part 1 of the catalogue .*



TAPICERIA DE ASIENTOS / SEATS COVERS

Cojín con respaldo para asiento tipo cubeta
Covers and cushions for old bucket seat

61/831-2
(K947556/7)

Juego cojines (Asiento y respaldo)
Cushions set (seat & back rest)

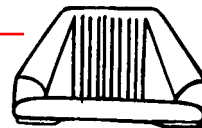
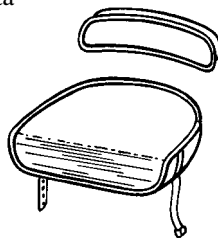

61/831-3
(K964819)

Respaldo (Asiento Grammer)
Cover (Grammer seat)



**AMORTIGUADOR
GAS STRUTS**

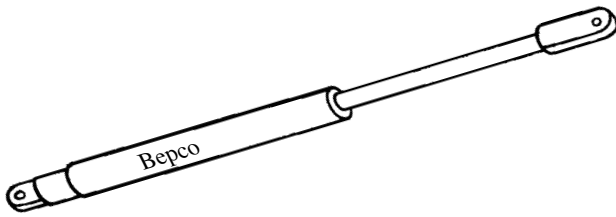

Ver nuestro gama completa en el fascículo 1 del catálogo general. / For further, see the complete range in part 1 of the catalogue .



| Tractores Tractors | Parabrisas Windscreen | Puerta Door | Techo Roof | Ventana trasera Rear window |
|--|--------------------------|---------------------------------------|---------------------------------------|---------------------------------------|
| 1190, 1290, 1390, 1490, 1690 (Modelos antiguos / Old models) | | 20/872-8 (K302896) 396mm | | |
| 1290, 1390, 1490, 1690, 1690T, 1194, 1294, 1394, 1494, 1594, 1694 | | 20/872-9 (K303870) 252mm | 20/871-7 (K303741) 255mm | 20/870-8 (K303743) 507mm |

ESCOBILLAS Y MOTORES DEL LIMPIA-PARABRISAS / WIPER MOTORS & BLADES

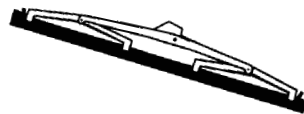

ESCOBILLAS / WIPER BLADES

70/1987-18 (K773406) 450 - 460mm
885, 990, 995, 996, 1210, 1212, 1410, 1412



70/1987-20 (K262711) 500 - 510mm
1190, 1194, 1290, 1294, 1390, 1394, 1490, 1494,
1594, 1690, 1690 TURBO, 1694

MOTORES DEL LIMPIA-PARABRISAS / WIPER MOTOR

63/1980-2 (10/112-85) 85° 
63/1980-3 (10/112-110) 110° 

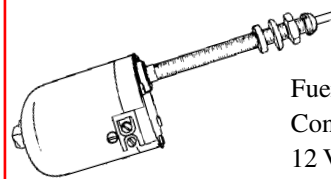









Fuerza / Torque 4,5 Newtons
Con interruptor / With switch
12 Volts



Ver nuestro gama completa en el fascículo 1 del catálogo general.
For further, see the complete range in part 1 of the catalogue .

**GOMA PARA CRISTALES DE CABINA
GLAZING RUBBER AND DRAFT EXCLUDERS**

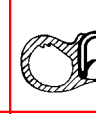
| | Secciones (Goma negra) Sections (Black rubber) | | | | | | Secciones (Negra) Sections (Black) | | | |
|------------------------------|---|---|---|---|---|---|--|---|---|---|
| Ref. Ref. |  |  |  |  |  |  |  |  |  |  |
| | 70/4110-9 (13/1200) (A) | 70/4110-10 (13/1206) (B) | 70/4110-11 (13/1207) (C) | 70/4111-4 (13/1201) | 70/4110-12 (13/1208) | 70/4110-13 (13/1209) | 70/4112-2 (13/1202) | 70/4112-3 (13/1203) | 70/4112-4 (13/1204) | 70/4112-5 (13/1205) |
| Tamaño cristal Glass size | 6,0mm | 4,7mm | 4,7mm | Filtro para Filler strip for A, B, C | 5,0mm | 4,0mm | | 2-5mm | 5-6mm | 6mm |
| Panel Panel | 1,2/1,6mm | 1,2/1,6mm | 2,6/3,2mm | | 2mm | 2mm | | | | |

Se vende en metros / Sold in metres

Las referencias originales tienen un propósito identificativo.
Nuestras piezas no son originales.

Part numbers are quoted for reference purposes only.
Our parts and accessories are not original.



CRISTAL DE CABINA
CAB GLASS

CABINA SEKURA / SEKURA CAB

885, 900, 990, 996, 1200, 1210, 1212, 1400, 1410, 1412
Tipo S-74, Type 164/163

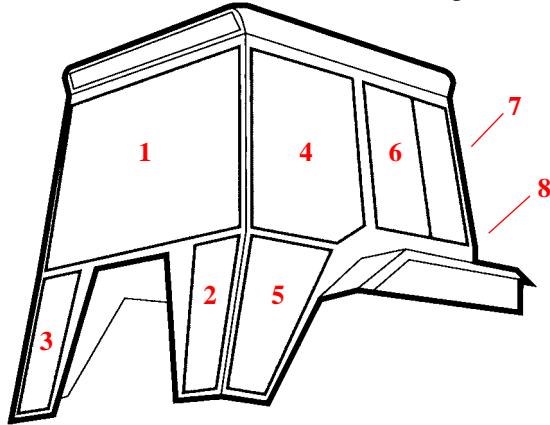

Todos los cristales no son tintados
All glasses not tinted

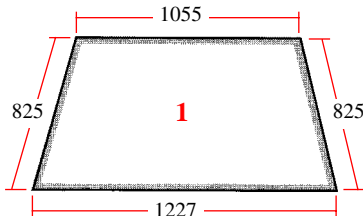

20/4002-2
(D7040, K965652)
Soporte + Parabrisas
Frame + windscreen

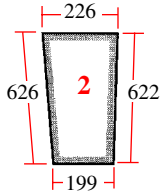

20/4015-2
(D7042, K965469)
Delantera (izq.)
Front (LH)

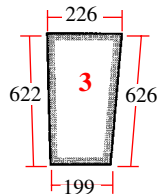

20/4016-2
(D7041, K965470)
Delantera (dcha)
Front (RH)

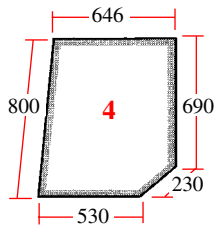

20/4035-1
(D7044, K965483)
Puerta (superior izq.)
Door (LH upper)

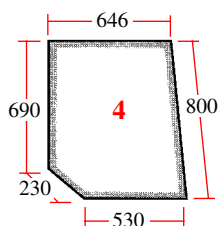

20/4034-1
(D7043, K965484)
Puerta (superior dcha)
Door (RH upper)

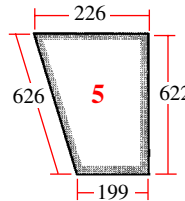

20/4037-1
(D7046, K965485)
Puerta (inferior izq.)
Door (LH lower)

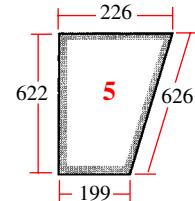

20/4036-1
(D7045, K965486)
Puerta (inferior dcha)
Door (RH lower)

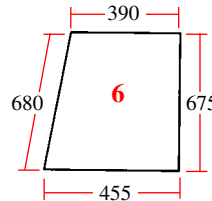

20/4041-5
(D7048/F)
Lateral (fijo)
(izq.o dcha)
Side fixed (LH & RH)

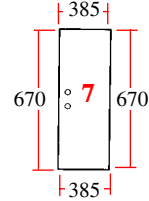

20/4040-3
(D7048/S)
Lateral (deslizante)
(izq.o dcha)
Side sliding (LH & RH)

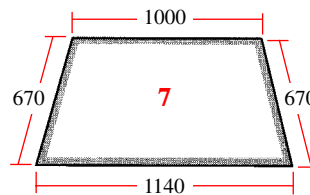

20/4077-1
(D7049, K965468)
Trasero (superior)
Rear (upper)

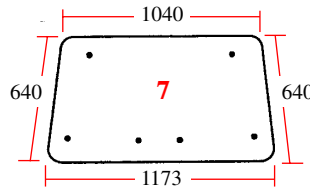

20/4072-23
(D7051, K965668)
Trasero (superior)
Super De-luxe
Rear (upper)

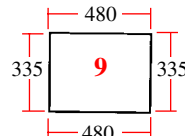

20/4075-3
(D7050/F)
Trasero (fijo)
Rear (fixed)

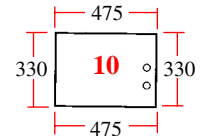

20/4074-3
(D7050/S)
Trasero (deslizante)
Rear (sliding)

Las referencias originales tienen un propósito identificativo.
Nuestras piezas no son originales.

*Part numbers are quoted for reference purposes only.
Our parts and accessories are not original.*



CRISTAL DE CABINA
CAB GLASS

CABINA "DE LUXE" / "DE LUXE" CAB

1190, 1194, 1290, 1294, 1390, 1394, 1594, 1690T, 1694
Tipo S-80, Type 415/417

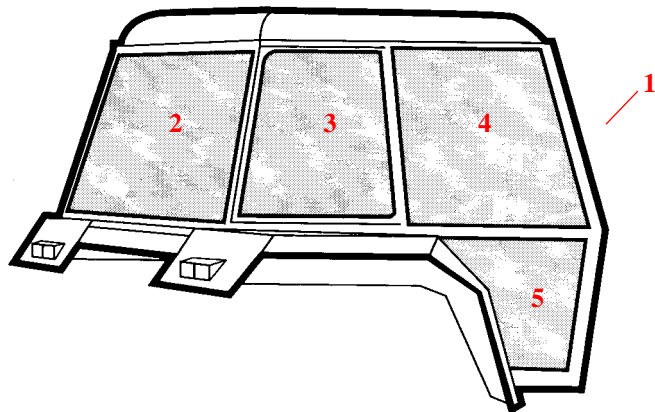

Todos los cristales son tintados
All glasses tinted

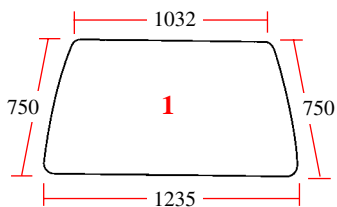

20/4000-37
(D7020, K303699)
Parabrisas
Windscreen

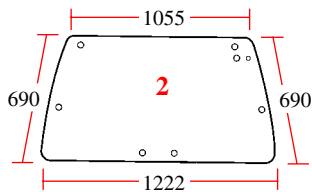

20/4072-26
(D7029, K312000)
Trasero 8 agujeros
Rear 8 holes

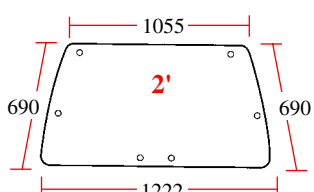

20/4072-27
(D7029/A, K303696)
Trasero 6 agujeros
Rear 6 holes

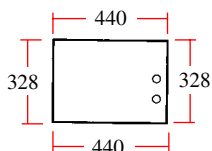

20/4074-4
(D7030, K303707)
Trasero (deslizante)
Rear (sliding)

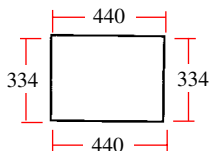

20/4075-4
(D7031, K303706)
Trasero (fijo)
Rear (fixed)

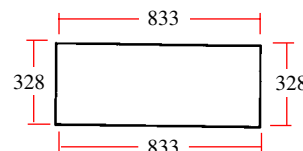

20/4073-16
(D7032, K303950)
Trasero (inferior)
Rear (lower)

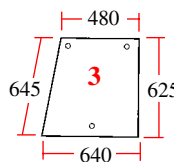

20/4045-3
(D7023, K303704)
Lateral (dcha)
Side (RH)

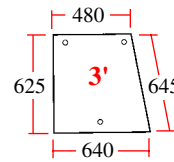

20/4043-2
(D7024, K303705)
Lateral (izq.)
Side (LH)

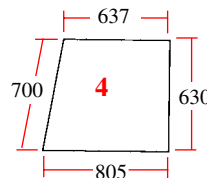

20/4028-2
(D7025, K303700)
Puerta (dcha)
Door (RH)

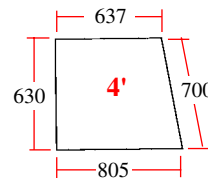

20/4039-6
(D7027, K303701)
Puerta (izq.)
Door (LH)

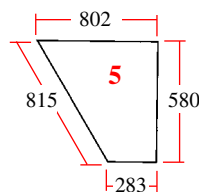

20/4038-6
(D7026, K303702)
Puerta (dcha)
Door (RH)

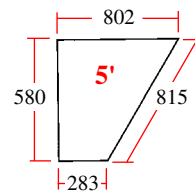

20/4029-2
(D7028, K303703)
Puerta (izq.)
Door (LH)

Las referencias originales tienen un propósito identificativo.
Nuestras piezas no son originales.

Part numbers are quoted for reference purposes only.
Our parts and accessories are not original.



LISTA DE REFERENCIAS CRUZADAS (OEM)
CROSS REFERENCES (OEM)

| OEM OEM | REF. ANTIGUA OLD REF. | REF. n° ORDER N° | PAGINA PAGE |
|------------------|--------------------------|---------------------|----------------|
| 1333291C1 | 25/1333291 | 20/181-22 | DB-13 |
| 205/04034 | 205/040304 | 62/919-17 | DB-25 |
| B3380 | | 20/33-80 | DB-5 |
| B3381 | | 20/33-81 | DB-5 |
| B3382 | | 20/33-82 | DB-5 |
| B3383 | | 20/33-83 | DB-5 |
| K11598 | D.11598 | 20/477-80 | DB-19 |
| K11638 | D.11638 | 20/174-80 | DB-14 |
| K11651 | D.11651 | 20/131-85A | DB-7 |
| K13353 | D.13353 | 20/402-80 | DB-18 |
| K14014 | D.14014 | 20/221-82 | DB-16 |
| K14083 | | 20/231-19 | DB-16 |
| K15594 | D.15594 | 20/476-80 | DB-19 |
| K19085 | D.19085 | 20/463-12 | DB-19 |
| K19167 | D.19167 | 20/230-10 | DB-16, DB-17 |
| K19169 | D.19169 | 20/231-21 | DB-16, DB-17 |
| K19177 | D.19177 | 20/231-22 | DB-16, DB-17 |
| K19186 | D.19186 | 20/460-12 | DB-19 |
| K19581 | D.19581 | 20/55-81 | DB-10 |
| K19903 | ET.54 | 63/950-81 | DB-15 |
| K19905 | D.19905 | 20/170-80 | DB-14 |
| K200037 | 305/F | 60/97-4 | DB-11 |
| K200219 | DO.201826 | 20/228-83 | DB-17, DB-18 |
| K200379 | D.200379 | 60/161-4 | DB-11 |
| K200380 | 20/200380 | 60/162-4 | DB-11 |
| K200464 | 20/200464 | 20/660-3 | DB-23 |
| K200465 | 20/200465 | 20/662-3 | DB-23 |
| K200550 | 20/200550 | 20/423-80 | DB-18 |
| K200652 | 20/200652 | 20/187-80 | DB-15 |
| K200679 | D.200679 | 20/130-80 | DB-7 |
| K200687 | 20/200687 | 20/131-86D | DB-7 |
| K200730 | DO.200730 | 20/153-83 | DB-8 |
| K200822 | D.200679 | 20/130-80 | DB-7 |
| K200831 | D.900368 | 20/143-80 | DB-7 |
| K200874 | DO.200874 | 20/154-87 | DB-8 |
| K201718 | D.201718 | 20/153-85 | DB-8 |
| K201747 | DO.201747 | 20/153-84 | DB-8 |
| K201976 | DO.201976 | 20/154-83 | DB-8 |
| K202291 | SCHA.30502 | 20/200-88 | DB-17 |
| K202625 | 20/202625 | 20/221-88 | DB-17 |
| K202825 | SCHA.30504 | 20/200-90 | DB-17 |
| K202826 | D.202826 | 20/221-90 | DB-17 |
| K202905 | DO.202905 | 20/422-80 | DB-18 |
| K203026 | 20/203026 | 20/680-80 | DB-20 |
| K203350 | DO.203350 | 20/154-84 | DB-8 |
| K203416 | DO.203416 | 20/228-82 | DB-17, DB-18 |
| K203991 | DO.203991 | 20/154-88 | DB-8 |
| K203992 | 10/1808 | 63/950-2 | DB-15 |
| K204963 (x 12) | | | |
| + K204971 (2 x) | 20/204963 K | 20/2-33A | DB-3 |
| K204964 | 20/204964 K | 20/2-33B | DB-3 |
| K204971 (2 x) | | | |
| + K204963 (x 12) | 20/204963 K | 20/2-33A | DB-3 |
| K204974 (x2) | 6-25 | 20/6-25 | DB-3 |
| K204975 (x2) | 6-25 | 20/6-25 | DB-3 |
| K206954 | 20/206954 | 20/32-83 | DB-4 |
| K206974 | 20/206974 | 20/32-83B | DB-4 |
| K207436 (x12) | 20/207436 (x6) | 20/3-33 | DB-3 |
| K207436 (x6) | 20/207436 (x3) | 20/3-30 | DB-3 |
| K207436 (x8) | 20/207436 (x4) | 20/3-31 | DB-3 |
| K207497 | 20/207497 (x3) | 20/3-30A | DB-3 |
| K207498 | 20/207498 (x3) | 20/3-30B | DB-3 |
| K207666 | DB.207666 | 20/377-81 | DB-20 |
| K207721 | D.923766 | 20/581-82 | DB-21 |
| K207722 | D.915962 | 20/491-81 | DB-21 |
| K208039 | D.917962 | 20/143-87 | DB-7 |
| K210049 | DO.210049 | 60/240-18 | DB-11 |
| K24659 | D.12459 | 20/463-10 | DB-19 |
| K260004 | 13/1443 | 70/4170-25 | DB-27 |
| K260133 | D.68949 | 20/131-80B | DB-7 |
| K260250 | 20/260250 | 20/495-81 | DB-21 |
| K260254 | 20/260254 | 20/496-81 | DB-21 |
| K260282 | 20/965803 | 20/72-61 | DB-6 |
| K260283 | D.964883 | 20/71-61 | DB-6 |

| OEM OEM | REF. ANTIGUA OLD REF. | REF. n° ORDER N° | PAGINA PAGE |
|------------|--------------------------|---------------------|----------------|
| K260284 | D.964883 | 20/71-61 | DB-6 |
| K260285 | D.964883 | 20/71-61 | DB-6 |
| K260286 | DO.260286 | 20/72-62 | DB-6 |
| K260287 | DO.260287 | 20/71-62 | DB-6 |
| K260382 | 20/260382 | 60/169-10 | DB-11 |
| K260880 | DO.260880 | 20/1913-22 | DB-13 |
| K260907 | 20/260907 | 60/169-12 | DB-11 |
| K260911 | DO.260911 | 20/1919-5 | DB-13 |
| K261069 | 20/261069 | 20/34-80 | DB-4 |
| K261070 | 20/261070 | 20/34-80B | DB-4 |
| K262024 | 54E.268/462 | 62/932-7 | DB-26 |
| K262025 | 54E.292/376 | 62/931-9 | DB-26 |
| K262026 | LU.77139 | 62/940-12 | DB-26 |
| K262028 | 54E.268/139 | 62/939-14 | DB-26 |
| K262161 | 20/262161 | 20/6403-81 | DB-20 |
| K262207 | 20/262207 | 20/470-74 | DB-19 |
| K262209 | 20/262209 | 20/470-72 | DB-19 |
| K262211 | 20/262211 | 20/470-73 | DB-19 |
| K262214 | 20/B1025 | 20/470-81 | DB-19 |
| K262265 | D.21/220 | 20/101-56 | DB-6 |
| K262711 | 10/3227 | 70/1987-20 | DB-29 |
| K300189 | D.300189 | 20/1912-23 | DB-13 |
| K300190 | D.300190 | 20/1912-22 | DB-13 |
| K300192 | 10/12500 | 63/1955-380 | DB-13 |
| K300194 | D.300194 | 20/1918-5 | DB-13 |
| K300195 | D.300195 | 20/1918-6 | DB-13 |
| K300297 | D.907985 | 20/180-80 | DB-14 |
| K300791/2 | 10/1699 | 63/953-1 | DB-15 |
| K302026 | D.302026 | 20/180-81 | DB-14 |
| K302424 | 15/1276 | 62/920-10 | DB-25 |
| K302896 | 20/302896 | 20/872-8 | DB-29 |
| K302952 | 20/302952 | 20/165-77 | DB-12 |
| K303696 | D.7029/A | 20/4072-27 | DB-31 |
| K303699 | D.7020 | 20/4000-37 | DB-31 |
| K303700 | D.7025 | 20/4028-2 | DB-31 |
| K303701 | D.7027 | 20/4039-6 | DB-31 |
| K303702 | D.7026 | 20/4038-6 | DB-31 |
| K303703 | D.7028 | 20/4029-2 | DB-31 |
| K303704 | D.7023 | 20/4045-3 | DB-31 |
| K303705 | D.7024 | 20/4043-2 | DB-31 |
| K303706 | D.7031 | 20/4075-4 | DB-31 |
| K303707 | D.7030 | 20/4074-4 | DB-31 |
| K303737 | | 60/4700-1 | DB-10 |
| K303741 | 20/303741 | 20/871-7 | DB-29 |
| K303743 | 20/303743 | 20/870-8 | DB-29 |
| K303755 | 13/1429 | 70/4170-21 | DB-27 |
| K303805 | 13/1438LH | 70/4170-19 | DB-27 |
| K303806 | 13/1436RH | 70/4170-20 | DB-27 |
| K303870 | 20/303870 | 20/872-9 | DB-29 |
| K303950 | D.7032 | 20/4073-16 | DB-31 |
| K304290 | 20/304290 | 20/165-74 | DB-12 |
| K304590 | D.901983 | 20/105-80 | DB-10 |
| K304708 | 20/304708 | 20/165-89 | DB-12 |
| K306484 | D.301289 | 20/165-78 | DB-12 |
| K306535 | D.306535 | 60/161-89 | DB-11 |
| K306549 | 15/1305 | 62/920-24 | DB-25 |
| K306549 | 510.E.343 | 62/920-26 | DB-25 |
| K306765 | 20/306765 | 20/13-20 | DB-3 |
| K307720 | 15/1276 | 62/920-10 | DB-25 |
| K307945 | DO.307058 | 20/640-208 | DB-22 |
| K308448 | AV13/1275 | 71/144-85 | DB-9 |
| K308650 | K.308650 | 62/930-15 | DB-26 |
| K309297 | 20/309297 | 20/172-81 | DB-14 |
| K309298 | 20/309298 | 20/172-82 | DB-14 |
| K309299 | 20/309299 | 20/172-83 | DB-14 |
| K310386 | 20/310386 | 20/640-211 | DB-22 |
| K311686 | D.903851 | 20/186-3 | DB-15 |
| K311943 | D.302026 | 20/180-81 | DB-14 |
| K312000 | D.7029 | 20/4072-26 | DB-31 |
| K31669 | D.31669 | 20/28-17 | DB-3 |
| K32676 | D.32676 | 20/462-26 | DB-19 |
| K33682 | D.33682 | 20/479-80 | DB-19 |
| K36134 | D.36134 | 20/15-80 | DB-10 |
| K37575 | D.37575 | 20/153-80 | DB-8 |

Las referencias originales tienen un propósito identificativo.
Nuestras piezas no son originales.

Part numbers are quoted for reference purposes only.
Our parts and accessories are not original.



"THE RELIABLE SERVICE"



LISTA DE REFERENCIAS CRUZADAS (OEM)
CROSS REFERENCES (OEM)

| OEM OEM | REF. ANTIGUA OLD REF. | REF. n° ORDER N° | PAGINA PAGE | OEM OEM | REF. ANTIGUA OLD REF. | REF. n° ORDER N° | PAGINA PAGE |
|--------------|-----------------------|------------------|-------------|-----------------|-----------------------|------------------|-------------|
| K600875 | D.600875 | 20/446-81 | DB-19 | K917637 (x 12) | | | |
| K611261 | D.611261 | 20/442-2 | DB-20 | +K917639 (x 2) | 20/917637 K | 20/2-33 | DB-3 |
| K611270 | D.611270 | 20/442-3 | DB-20 | K917639 (x 2) | | | |
| K617006 | D.617006 | 20/443-3 | DB-20 | +K917637 (x 12) | 20/917637 K | 20/2-33 | DB-3 |
| K617157 | 20/617157 | 20/452-80 | DB-19 | K917891 | 20/917891 | 20/15-82 | DB-10 |
| K620046 | D.620046 | 20/462-11 | DB-19 | K918611 | SCHA.2888 | 20/200-84 | DB-16 |
| K620076 | D.620076 | 20/462-10 | DB-19 | K918689 (x 2) | D.918689 | 20/74-35 | DB-6 |
| K620085 | D.620085 | 20/231-80 | DB-16 | K919048 | D.919048 | 20/640-207 | DB-22 |
| K620153 | D.19169 | 20/231-21 | DB-16 | K920522 | D.920522 | 60/240-19 | DB-11 |
| K620167 | D.620167 | 20/462-25 | DB-19 | K921317 | D.921317 | 20/186-80 | DB-15 |
| K620182 | D.620182 | 20/231-20 | DB-16 | K921435 | 20/921435 | 20/44-16 | DB-5 |
| K620202 | D.620202 | 20/131-87A | DB-7 | K921436 | 20/921436 | 20/45-16 | DB-5 |
| K62185 | 102T | 60/96-3 | DB-11 | K921611 | 20/921611 | 20/13-18 | DB-3 |
| K622060 | D.622060 | 20/55-80 | DB-10 | K921972 | D.916316 | 20/153-81 | DB-8 |
| K622061 | D.622061 | 20/103-80 | DB-10 | K922634 | D.922634 | 20/710-81 | DB-24 |
| K623419 | D.623419 | 20/461-12 | DB-19 | K923374 | D.89321 | 20/221-84 | DB-16 |
| K623450 | D.15638 | 20/461-10 | DB-19 | K923766 | D.923766 | 20/581-82 | DB-21 |
| K62594 | 1005 | 60/111-2 | DB-11 | K925009 | 510.E.344 | 62/920-87 | DB-25 |
| K626673 | 20/626873 | 20/451-80 | DB-19 | K926603 | D.926603 | 20/154-86 | DB-8 |
| K628127 | 20/628127 | 20/11-20 | DB-3 | K928275 | 20/928275 | 20/164-80 | DB-12 |
| K62957 | 1005 | 60/111-2 | DB-11 | K928523 | D.928523 | 20/60-2 | DB-3 |
| K66442 | D.21/221 | 20/102-3 | DB-6 | K928540 | 20/928540 | 20/2-30 | DB-3 |
| K67922 | D.67922 | 20/34-79 | DB-4 | K928541 | 20/928541 | 20/2-31 | DB-3 |
| K68073 | D.68073 | 71/144-82 | DB-9 | K928542 (x2) | 20/928542 | 20/6-20 | DB-3 |
| K68859 | 1001 | 60/111-1 | DB-11 | K928543 (x2) | 20/928542 | 20/6-20 | DB-3 |
| K773205/6 | 13/1445 | 70/4170-85 | DB-27 | K928554 | 20/928554 | 20/2-31A | DB-3 |
| K773406 | 10/3225 | 70/1987-18 | DB-29 | K928555 | 20/928555 | 20/2-31B | DB-3 |
| K83746 | D.83746 | 20/510-80 | DB-20 | K928557 | 20/928557 | 20/2-30A | DB-3 |
| K88481 | D.88481 | 20/154-79 | DB-8 | K928558 | 20/928558 | 20/2-30B | DB-3 |
| K89321 | D.89321 | 20/221-84 | DB-16 | K928560 (x2) | 6-21 | 20/6-21 | DB-3 |
| K89322 | D.89322 | 20/212-19 | DB-16 | K928561 (x2) | 6-21 | 20/6-21 | DB-3 |
| K900054 | D.900054 | 20/710-80 | DB-24 | K928622 | D.928622 | 20/42-30 | DB-5 |
| K900055 | D.900055 | 20/719-80 | DB-24 | K928643 | LU.22703/N | 62/910-1 | DB-25 |
| K900136 | 37.LU.229 | 62/919-1 | DB-25 | K928712 | D.917634 | 20/165-80 | DB-12 |
| K901111 | D.901111 | 71/144-88 | DB-9 | K928997 | 20/928997 | 20/2-32 | DB-3 |
| K901983 | D.901983 | 20/105-80 | DB-10 | K928998 (x2) | 20/928998 | 20/6-22 | DB-3 |
| K902092 | D.945362 | 20/151-81 | DB-10 | K928999 (x2) | 20/928998 | 20/6-22 | DB-3 |
| K902125 | 73 | 60/96-18 | DB-11 | K929057 | D.929057 | 20/581-83 | DB-21 |
| K903050 | D.903050 | 71/144-84 | DB-9 | K929148 | 20/929148 (x4) | 20/3-32 | DB-3 |
| K903851 | D.903851 | 20/186-3 | DB-15 | K929737 | 20/929737 | 20/962-80 | DB-15 |
| K904880 | D.904880 | 20/154-77 | DB-8 | K940135 | 20/940135 | 20/13-19 | DB-3 |
| K905229 | D.905229 | 20/74-34 | DB-6 | K942053 | D.942053 | 71/144-81 | DB-9 |
| K906196 | D.945363 | 20/151-80 | DB-10 | K942176 | DB.70119 | 20/117-49 | DB-3 |
| K906875 | D.906875 | 20/154-80 | DB-8 | K942227 | D.924339 | 20/175-80 | DB-14 |
| K907008 | D.907008 | 20/730-81 | DB-24 | K943357 | 20/943357 | 20/131-80D | DB-7 |
| K907338 | D.907338 | 20/74-33 | DB-6 | K943439 | 20/943439 | 20/46-4 | DB-5 |
| K907400 | D.907400 | 20/446-80 | DB-19 | K944573 | 20/944573 | 20/32-82 | DB-4 |
| K907985 | D.907985 | 20/180-80 | DB-14 | K944947 | 20/944947 | 20/663-3 | DB-23 |
| K908071 | D.908071 | 20/491-80 | DB-21 | K944950 | 20/944950 | 20/660-2 | DB-23 |
| K908819 | D.908819 | 20/100-56 | DB-6 | K944997 | D.909944 | 20/100-57 | DB-6 |
| K908882 | LU.22703/N | 62/910-1 | DB-25 | K945043 | D.945043 | 60/161-90 | DB-11 |
| K908901 | 37.RB.408 | 62/919-2 | DB-25 | K945287 | D.945287 | 20/154-82 | DB-8 |
| K909944 | D.909944 | 20/100-57 | DB-6 | K945362 | D.945362 | 20/151-81 | DB-10 |
| K910538 | 20/910538 | 20/662-2 | DB-23 | K945363 | D.945363 | 20/151-80 | DB-10 |
| K910886 | D.910886 | 20/212-18 | DB-16 | K945753 | 20/945753 | 20/417-81 | DB-18 |
| K911917 | D.911917 | 20/101-56M | DB-6 | K945754 | DO.945754 | 20/422-81 | DB-18 |
| K912034 | D.912034 | 20/154-75 | DB-8 | K945755 | DO.945755 | 20/423-81 | DB-18 |
| K912039 | D.912039 | 20/154-78 | DB-8 | K946158 | DO.946158 | 20/172-80 | DB-14 |
| K912196 | D.912196 | 71/144-80 | DB-9 | K946345 | 20/946345 | 20/2-32A | DB-3 |
| K912228 | D.912228 | 20/730-80 | DB-24 | K946346 | 20/946346 | 20/2-32B | DB-3 |
| K912411 | 20/912411 | 20/530-80 | DB-20 | K946347 (x2) | 6-23 | 20/6-23 | DB-3 |
| K913007 | K.957341 | 62/930-6 | DB-26 | K946348 (x2) | 6-23 | 20/6-23 | DB-3 |
| K914137 | D.905166 | 20/165-72 | DB-12 | K946351 | 20/946351 (x4) | 20/3-32A | DB-3 |
| K914441 | 165 | 60/240-8 | DB-11 | K946352 | 20/946352 (x4) | 20/3-32B | DB-3 |
| K915206 | D.915206 | 20/154-76 | DB-8 | K946819 | 20/946819 | 20/15-81 | DB-10 |
| K915319 | 1087/PK | 60/111-3 | DB-11 | K946849 | D.946849 | 20/153-82 | DB-8 |
| K915329 | 20/915329 | 20/131-85D | DB-7 | K947089 | 20/947089 | 20/212-21 | DB-17 |
| K915379 | D.14014 | 20/221-82 | DB-16 | K947556/7 | DB.901C | 61/831-2 | DB-28 |
| K915827 | D.915827 | 20/212-20 | DB-16 | K947732 | 20/947732 | 20/860-81 | DB-28 |
| K915962 | D.915962 | 20/491-81 | DB-21 | K947937 | D.947937 | 20/449-11 | DB-20 |
| K916535 | 20/916535 | 20/640-210 | DB-22 | K947940 | D.947940 | 20/449-80 | DB-20 |
| K917374 | D.917374 | 20/171-80 | DB-14 | K947941 | D.947941 | 20/449-12 | DB-20 |
| K917635 (x2) | 20/917635 | 20/6-24 | DB-3 | K948393 | 20/948393 | 20/303-80 | DB-20 |
| K917636 (x2) | 20/917635 | 20/6-24 | DB-3 | | | | |

Las referencias originales tienen un propósito identificativo.
Nuestras piezas no son originales.

Part numbers are quoted for reference purposes only.
Our parts and accessories are not original.



"THE RELIABLE SERVICE"



LISTA DE REFERENCIAS CRUZADAS (OEM)
CROSS REFERENCES (OEM)

| OEM OEM | REF. ANTIGUA OLD REF. | REF. n° ORDER N° | PAGINA PAGE | OEM OEM | REF. ANTIGUA OLD REF. | REF. n° ORDER N° | PAGINA PAGE |
|---------------|--------------------------|---------------------|----------------|------------|--------------------------|---------------------|----------------|
| K948427 | D.902118 | 20/85-80 | DB-10 | K964542 | D.962269 | 20/404-82K | DB-18 |
| K948453 | D.948453 | 20/154-81 | DB-8 | K964572 | DB.6/378 | 20/227-80 | DB-17, DB-18 |
| K948533 | D.901132 | 20/177-80 | DB-15 | K964573 | DB.181/31 | 20/229-80 | DB-17 |
| K949207 | 20/949207 | 20/860-82 | DB-28 | K964576 | D.964576 | 20/229-81 | DB-17 |
| K949208 | 20/949208 | 20/860-83 | DB-28 | K964819 | D.902 | 61/831-3 | DB-28 |
| K949210 | 20/949210 | 20/860-84 | DB-28 | K964857 | 20/964857 | 20/36-80 | DB-4 |
| K949311 | D.949311 | 71/144-83 | DB-9 | K964876 | D.964876 | 20/71-60 | DB-6 |
| K949474 | 20/949474 | 20/32-81 | DB-4 | K964877 | 20/964877 | 20/72-60 | DB-6 |
| K949605 | 20/949605 | 20/640-209 | DB-22 | K964883 | DO.260283 | 20/71-61 | DB-6 |
| K949719 | 20/949719 | 20/32-81B | DB-4 | K964935 | D.964935 | 20/575-206 | DB-22 |
| K949721 | 20/949721 | 20/32-80 | DB-4 | K964954 | D.964931 | 20/574-16 | DB-22 |
| K949722 | 20/949722 | 20/32-80B | DB-4 | K965215 | | 20/6403-20 | DB-20 |
| K949731 | D.947731 | 20/449-13 | DB-20 | K965269 | D.965269 | 20/495-80 | DB-21 |
| K950100 | 20/950100 | 20/43-31 | DB-5 | K965270 | D.965270 | 20/496-80 | DB-21 |
| K950544 | D.950544 | 20/226-80 | DB-17, DB-18 | K965331 | 20/965331 | 20/6403-80 | DB-20 |
| K952267 | D.952267 | 20/228-80 | DB-17 | K965468 | D.7049 | 20/4077-1 | DB-30 |
| K952378 | D.952378 | 20/212-22 | DB-17 | K965469 | D.7042 | 20/4015-2 | DB-30 |
| K952488 | 20/952488 | 20/165-76 | DB-12 | K965470 | D.7041 | 20/4016-2 | DB-30 |
| K952527 (x 2) | D.952527 | 20/73-63 | DB-6 | K965483 | D.7044 | 20/4035-1 | DB-30 |
| K952969 | 20/952969 | 20/164-81 | DB-12 | K965484 | D.7043 | 20/4034-1 | DB-30 |
| K953783 | D.947758 | 20/73-61 | DB-6 | K965485 | D.7046 | 20/4037-1 | DB-30 |
| K953894 | | 20/90-42 | DB-3 | K965486 | D.7045 | 20/4036-1 | DB-30 |
| K954090 | D.954090 | 20/165-88 | DB-12 | K965652 | D.7040 | 20/4002-2 | DB-30 |
| K954646 | D.954646 | 20/735-80 | DB-24 | K965668 | | 20/4072-23 | DB-30 |
| K954738 | 20/954738 | 20/417-80 | DB-18 | K965723 | D.965723 | 20/229-82 | DB-17, DB-18 |
| K954959 | D.954959 | 20/177-19 | DB-15 | K965765 | D.965765 | 20/229-83 | DB-17 |
| K955435 | 13/1447 | 70/4170-84 | DB-27 | K965803 | 20/965803 | 20/72-61 | DB-6 |
| K955448 | 6821 | 70/4170-86 | DB-27 | K965848 | DO.965848 | 20/131-80 | DB-7 |
| K955687 | 599AR/F | 60/97-2 | DB-11 | K965860 | DO.965860 | 20/131-86 | DB-7 |
| K956051 | SCHA.30503 | 20/200-89 | DB-17 | K965888 | DO.965888 | 20/131-87 | DB-7 |
| K956052 | SP.30552 | 20/221-89 | DB-17 | K965963 | D.965963 | 20/72-63 | DB-6 |
| K956426 | 15/1068 | 62/920-4 | DB-25 | K965964 | D.965964 | 20/71-63 | DB-6 |
| K956426 | 510E324 | 62/920-27 | DB-25 | R9331K | R9331K | 20/107-2 | DB-15 |
| K956672 | D.914384 | 20/73-60 | DB-6 | RB-4294 | 102T | 60/96-3 | DB-11 |
| K957252 | SCHA.2532 | 20/200-86 | DB-16 | TAB118 | 54E.259/517 | 62/933-3 | DB-26 |
| K957254 | D.919861 | 20/221-86 | DB-16 | TAB125 | 271E.735 | 62/933-2 | DB-26 |
| K957318 | 20/957318 | 20/570-206 | DB-22 | TCB118 | 54E.243/853 | 62/934-1 | DB-26 |
| K957340 | LUR/26278 | 62/930-3 | DB-26 | TEB129 | 54E.244/973 | 62/932-4 | DB-26 |
| K957341 | K.957341 | 62/930-6 | DB-26 | TEB132 | 272E.394 | 62/932-3 | DB-26 |
| K957379 | 20/957379 | 20/177-18 | DB-15 | TEB144 | 54E.268/462 | 62/932-7 | DB-26 |
| K957435 | 228.0087.10 | 20/200-87 | DB-16 | TIB108 | 54E.247/379 | 62/931-5 | DB-26 |
| K957436 | SPHB.4552 | 20/221-87 | DB-16 | TIB113 | 54E.251/818 | 62/931-3 | DB-26 |
| K960595 | D.960595 | 20/404-80K | DB-18 | TIB114 | 54E.255/952 | 62/931-4 | DB-26 |
| K960750 | D.960750 | 20/574-15 | DB-22 | TJB103 | 54E.243/590 | 62/931-7 | DB-26 |
| | | | | TJB114 | 54E.292/376 | 62/931-9 | DB-26 |
| K960911 | 1087/PK | 60/111-3 | DB-11 | TLB117 | 292E.130 | 62/939-3 | DB-26 |
| K961001 | D.961001 | 20/71-93 | DB-6 | TMB107 | LU/TMB.107 | 62/939-36 | DB-26 |
| K961725 | D.961725 | 20/470-80 | DB-19 | TMB11 | 54E.258/190 | 62/939-11 | DB-26 |
| K961733 | D.961733 | 20/102-1 | DB-6 | TMB124 | LU/TMB.124 | 62/939-4 | DB-26 |
| K961770 | D.961770 | 20/131-84 | DB-7 | TMB148 | 54E.268/139 | 62/939-14 | DB-26 |
| K962146 | 20/962146 | 20/181-17 | DB-13 | TOB110 | LU.76836 | 62/940-9 | DB-26 |
| K962148/53 | 20/162148 | 20/860-85 | DB-28 | TOB153 | LU.76458 | 62/940-5 | DB-26 |
| K962266 | D.962266 | 20/404-81K | DB-18 | TOB162 | LU.76796 | 62/940-7 | DB-26 |
| K962269 | D.962269 | 20/404-82K | DB-18 | TPB111 | LU.77139 | 62/940-12 | DB-26 |
| K962479 | 20/962479 | 20/860-80 | DB-28 | UCB100 | 37UCB612 | 62/919-80 | DB-25 |
| K962635 | 20/962635 | 20/640-206 | DB-22 | UCB109 | 37UCB584 | 62/919-81 | DB-25 |
| K962763 | 10/12821 | 63/1955-207 | DB-13 | ULB110 | 54E.219/368 | 62/923-1 | DB-25 |
| K962984 | 20/B1022 | 20/460-10 | DB-19 | USB104 | 227E.541 | 62/913-2 | DB-25 |
| K962985 | 20/B1023 | 20/460-11 | DB-19 | UTB107 | 189E.237 | 62/915-1 | DB-25 |
| K962986 | 20/B1024 | 20/460-12 | DB-19 | UTB110 | 227E.818 | 62/914-1 | DB-25 |
| K963644 | 20/963644 | 20/419-80 | DB-18 | UWB102 | 54E.213/780 | 62/911-2 | DB-25 |
| K963645 | 20/963645 | 20/418-80 | DB-18 | | | | |
| K963791 | 54E.243/853 | 62/934-1 | DB-26 | | | | |
| K963825 | LU.76796 | 62/940-7 | DB-26 | | | | |
| K963886 | 10/12498 | 63/1955-382 | DB-13 | | | | |
| K963931 | 54E.243/853 | 62/934-1 | DB-26 | | | | |
| K964185 | 54E.247/379 | 62/931-5 | DB-26 | | | | |
| K964210 | 54E.244/973 | 62/932-4 | DB-26 | | | | |
| K964214 | 54E.258/190 | 62/939-11 | DB-26 | | | | |
| K964215 | LU.76836 | 62/940-9 | DB-26 | | | | |
| K964218 | 54E.259/517 | 62/933-3 | DB-26 | | | | |
| K964221 | 54E.243/590 | 62/931-7 | DB-26 | | | | |
| K964242 | LU/TMB.124 | 62/939-4 | DB-26 | | | | |
| K964489 | DO.964489 | 20/131-85 | DB-7 | | | | |

Las referencias originales tienen un propósito identificativo.
Nuestras piezas no son originales.

Part numbers are quoted for reference purposes only.
Our parts and accessories are not original.



"THE RELIABLE SERVICE"



LISTA DE REFERENCIAS CRUZADAS (Ref. n°)
CROSS REFERENCES (Order N°)

| REF. n° ORDER N° | REF. ANTIGUA OLD REF. | OEM OEM REF. | PAGINA PAGE | REF. n° ORDER N° | REF. ANTIGUA OLD REF. | OEM OEM REF. | PAGINA PAGE |
|---------------------|--------------------------|----------------------------------|----------------|---------------------|--------------------------|-----------------|----------------|
| 20/2-30 | 20/928540 | K928540 | DB-3 | 20/72-61 | 20/965803 | K260282 | DB-6 |
| 20/2-30A | 20/928557 | K928557 | DB-3 | 20/72-61 | 20/965803 | K965803 | DB-6 |
| 20/2-30B | 20/928558 | K928558 | DB-3 | 20/72-62 | DO.260286 | K260286 | DB-6 |
| 20/2-31 | 20/928541 | K928541 | DB-3 | 20/72-63 | D.965963 | K965963 | DB-6 |
| 20/2-31A | 20/928554 | K928554 | DB-3 | 20/73-60 | D.914384 | K956672 | DB-6 |
| 20/2-31B | 20/928555 | K928555 | DB-3 | 20/73-61 | D.947758 | K953783 | DB-6 |
| 20/2-32 | 20/928997 | K928997 | DB-3 | 20/73-63 | D.952527 | K952527 (x 2) | DB-6 |
| 20/2-32A | 20/946345 | K946345 | DB-3 | 20/74-33 | D.907338 | K907338 | DB-6 |
| 20/2-32B | 20/946346 | K946346 | DB-3 | 20/74-34 | D.905229 | K905229 | DB-6 |
| 20/2-33 | 20/917637 K | K917639 (x 2) +K917637 (x 12) | DB-3 | 20/74-35 | D.918689 | K918689 (x 2) | DB-6 |
| 20/2-33A | 20/204963 K | K204971 (2 x) +K204963 (x 12) | DB-3 | 20/85-80 | D.902118 | K948427 | DB-10 |
| 20/2-33B | 20/204964 K | K204964 | DB-3 | 20/90-42 | | K953894 | DB-3 |
| 20/3-30 | 20/207436 (x3) | K207436 (x6) | DB-3 | 60/96-3 | 102T | K62185 | DB-11 |
| 20/3-30A | 20/207497 (x3) | K207497 | DB-3 | 60/96-3 | 102T | RB-4294 | DB-11 |
| 20/3-30B | 20/207498 (x3) | K207498 | DB-3 | 60/96-18 | 73 | K902125 | DB-11 |
| 20/3-31 | 20/207436 (x4) | K207436 (x8) | DB-3 | 60/97-2 | 599AR/F | K955687 | DB-11 |
| 20/3-32 | 20/929148 (x4) | K929148 | DB-3 | 60/97-4 | 305/F | K200037 | DB-11 |
| 20/3-32A | 20/946351 (x4) | K946351 | DB-3 | 20/100-56 | D.908819 | K908819 | DB-6 |
| 20/3-32B | 20/946352 (x4) | K946352 | DB-3 | 20/100-57 | D.909944 | K909944 | DB-6 |
| 20/3-33 | 20/207436 (x6) | K207436 (x12) | DB-3 | 20/100-57 | D.909944 | K944997 | DB-6 |
| 20/6-20 | 20/928542 | K928542 (x2) +K928543 (x2) | DB-3 | 20/101-56 | D.21/220 | K262265 | DB-6 |
| 20/6-21 | 6-21 | K928560 (x2) +K928561 (x2) | DB-3 | 20/101-56M | D.911917 | K911917 | DB-6 |
| 20/6-22 | 20/928998 | K928998 (x2) +K928999 (x2) | DB-3 | 20/102-1 | D.961733 | K961733 | DB-6 |
| 20/6-23 | 6-23 | K946347 (x2) +K946348 (x2) | DB-3 | 20/102-3 | D.21/221 | K66442 | DB-6 |
| 20/6-24 | 20/917635 | K917635 (x2) +K917636 (x2) | DB-3 | 20/103-80 | D.622061 | K622061 | DB-10 |
| 20/6-25 | 6-25 | K204974 (x2) +K204975 (x2) | DB-3 | 20/105-80 | D.901983 | K304590 | DB-10 |
| 20/11-20 | 20/628127 | K628127 | DB-3 | 20/105-80 | D.901983 | K901983 | DB-10 |
| 20/13-18 | 20/921611 | K921611 | DB-3 | 20/107-2 | R9331K | R9331K | DB-15 |
| 20/13-19 | 20/940135 | K940135 | DB-3 | 60/111-1 | 1001 | K68859 | DB-11 |
| 20/13-20 | 20/306765 | K306765 | DB-3 | 60/111-2 | 1005 | K62594 | DB-11 |
| 20/15-80 | D.36134 | K36134 | DB-10 | 60/111-2 | 1005 | K62957 | DB-11 |
| 20/15-81 | 20/946819 | K946819 | DB-10 | 60/111-3 | 1087/PK | K915319 | DB-11 |
| 20/15-82 | 20/917891 | K917891 | DB-10 | 60/111-3 | 1087/PK | K960911 | DB-11 |
| 20/28-17 | D.31669 | K31669 | DB-3 | 60/112-1 | 7111/403 | | DB-11 |
| 20/32-80 | 20/949721 | K949721 | DB-4 | 60/112-2 | 7111/429 | | DB-11 |
| 20/32-80B | 20/949722 | K949722 | DB-4 | 20/117-49 | DB.70119 | K942176 | DB-3 |
| 20/32-81 | 20/949474 | K949474 | DB-4 | 20/130-80 | D.200679 | K200679 | DB-7 |
| 20/32-81B | 20/949719 | K949719 | DB-4 | 20/130-80 | D.200679 | K200822 | DB-7 |
| 20/32-82 | 20/944573 | K944573 | DB-4 | 20/131-80 | DO.965848 | K965848 | DB-7 |
| 20/32-83 | 20/206954 | K206954 | DB-4 | 20/131-80B | D.68949 | K260133 | DB-7 |
| 20/32-83B | 20/206974 | K206974 | DB-4 | 20/131-80D | 20/943357 | K943357 | DB-7 |
| 20/33-80 | B3380 | | DB-5 | 20/131-84 | D.961770 | K961770 | DB-7 |
| 20/33-81 | B3381 | | DB-5 | 20/131-85 | DO.964489 | K964489 | DB-7 |
| 20/33-82 | B3382 | | DB-5 | 20/131-85A | D.11651 | K11651 | DB-7 |
| 20/33-83 | B3383 | | DB-5 | 20/131-85D | 20/915329 | K915329 | DB-7 |
| 20/34-79 | D.67922 | K67922 | DB-4 | 20/131-86 | DO.965860 | K965860 | DB-7 |
| 20/34-80 | 20/261069 | K261069 | DB-4 | 20/131-86D | 20/200687 | K200687 | DB-7 |
| 20/34-80B | 20/261070 | K261070 | DB-4 | 20/131-87 | DO.965888 | K965888 | DB-7 |
| 20/36-80 | 20/964857 | K964857 | DB-4 | 20/131-87A | D.620202 | K620202 | DB-7 |
| 20/42-30 | D.928622 | K928622 | DB-5 | 20/143-80 | D.900368 | K200831 | DB-7 |
| 20/43-31 | 20/950100 | K950100 | DB-5 | 20/143-87 | D.917962 | K208039 | DB-7 |
| 20/44-16 | 20/921435 | K921435 | DB-5 | 71/144-80 | D.912196 | K912196 | DB-9 |
| 20/45-16 | 20/921436 | K921436 | DB-5 | 71/144-81 | D.942053 | K942053 | DB-9 |
| 20/46-4 | 20/943439 | K943439 | DB-5 | 71/144-82 | D.68073 | K68073 | DB-9 |
| 20/55-80 | D.622060 | K622060 | DB-10 | 71/144-83 | D.949311 | K949311 | DB-9 |
| 20/55-81 | D.19581 | K19581 | DB-10 | 71/144-84 | D.903050 | K903050 | DB-9 |
| 20/60-2 | D.928523 | K928523 | DB-3 | 71/144-85 | AV13/1275 | K308448 | DB-9 |
| 20/71-60 | D.964876 | K964876 | DB-6 | 71/144-88 | D.901111 | K901111 | DB-9 |
| 20/71-61 | D.964883 | K260283 | DB-6 | 20/151-80 | D.945363 | K906196 | DB-10 |
| 20/71-61 | D.964883 | K260284 | DB-6 | 20/151-80 | D.945363 | K945363 | DB-10 |
| 20/71-61 | D.964883 | K260285 | DB-6 | 20/151-81 | D.945362 | K902092 | DB-10 |
| 20/71-61 | DO.260283 | K964883 | DB-6 | 20/151-81 | D.945362 | K945362 | DB-10 |
| 20/71-62 | DO.260287 | K260287 | DB-6 | 20/153-80 | D.37575 | K37575 | DB-8 |
| 20/71-63 | D.965964 | K965964 | DB-6 | 20/153-81 | D.916316 | K921972 | DB-8 |
| 20/71-93 | D.961001 | K961001 | DB-6 | 20/153-82 | D.946849 | K946849 | DB-8 |
| 20/72-60 | 20/964877 | K964877 | DB-6 | 20/153-83 | DO.200730 | K200730 | DB-8 |
| | | | | 20/153-84 | DO.201747 | K201747 | DB-8 |
| | | | | 20/153-85 | D.201718 | K201718 | DB-8 |
| | | | | 20/154-75 | D.912034 | K912034 | DB-8 |
| | | | | 20/154-76 | D.915206 | K915206 | DB-8 |
| | | | | 20/154-77 | D.904880 | K904880 | DB-8 |
| | | | | 20/154-78 | D.912039 | K912039 | DB-8 |
| | | | | 20/154-79 | D.88481 | K88481 | DB-8 |
| | | | | 20/154-80 | D.906875 | K906875 | DB-8 |

Las referencias originales tienen un propósito identificativo.
Nuestras piezas no son originales.

Part numbers are quoted for reference purposes only.
Our parts and accessories are not original.



"THE RELIABLE SERVICE"



LISTA DE REFERENCIAS CRUZADAS (Ref. n°)
CROSS REFERENCES (Order N°)

| REF. n° ORDER N° | REF. ANTIGUA OLD REF. | OEM OEM REF. | PAGINA PAGE |
|---------------------|--------------------------|-----------------|----------------|
| 20/154-81 | D.948453 | K948453 | DB-8 |
| 20/154-82 | D.945287 | K945287 | DB-8 |
| 20/154-83 | DO.201976 | K201976 | DB-8 |
| 20/154-84 | DO.203350 | K203350 | DB-8 |
| 20/154-86 | D.926603 | K926603 | DB-8 |
| 20/154-87 | DO.200874 | K200874 | DB-8 |
| 20/154-88 | DO.203991 | K203991 | DB-8 |
| 60/161-4 | D.200379 | K200379 | DB-11 |
| 60/161-89 | D.306535 | K306535 | DB-11 |
| 60/161-90 | D.945043 | K945043 | DB-11 |
| 60/162-4 | 20/200380 | K200380 | DB-11 |
| 20/164-80 | 20/928275 | K928275 | DB-12 |
| 20/164-81 | 20/952969 | K952969 | DB-12 |
| 20/165-72 | D.905166 | K914137 | DB-12 |
| 20/165-74 | 20/304290 | K304290 | DB-12 |
| 20/165-76 | 20/952488 | K952488 | DB-12 |
| 20/165-77 | 20/302952 | K302952 | DB-12 |
| 20/165-78 | D.301289 | K306484 | DB-12 |
| 20/165-80 | D.917634 | K928712 | DB-12 |
| 20/165-88 | D.954090 | K954090 | DB-12 |
| 20/165-89 | 20/304708 | K304708 | DB-12 |
| 60/169-10 | 20/260382 | K260382 | DB-11 |
| 60/169-10 | | | DB-11 |
| 60/169-12 | 20/260907 | K260907 | DB-11 |
| 20/170-80 | D.19905 | K19905 | DB-14 |
| 20/171-80 | D.917374 | K917374 | DB-14 |
| 20/172-80 | DO.946158 | K946158 | DB-14 |
| 20/172-81 | 20/309297 | K309297 | DB-14 |
| 20/172-82 | 20/309298 | K309298 | DB-14 |
| 20/172-83 | 20/309299 | K309299 | DB-14 |
| 20/174-80 | D.11638 | K11638 | DB-14 |
| 20/175-80 | D.924339 | K942227 | DB-14 |
| 20/177-18 | 20/957379 | K957379 | DB-15 |
| 20/177-19 | D.954959 | K954959 | DB-15 |
| 20/177-80 | D.901132 | K948533 | DB-15 |
| 20/180-80 | D.907985 | K300297 | DB-14 |
| 20/180-80 | D.907985 | K907985 | DB-14 |
| 20/180-81 | D.302026 | K302026 | DB-14 |
| 20/180-81 | D.302026 | K311943 | DB-14 |
| 20/181-17 | 20/962146 | K962146 | DB-13 |
| 20/181-22 | 25/1333291 | 1333291C1 | DB-13 |
| 20/186-3 | D.903851 | K311686 | DB-15 |
| 20/186-3 | D.903851 | K903851 | DB-15 |
| 20/186-80 | D.921317 | K921317 | DB-15 |
| 20/187-80 | 20/200652 | K200652 | DB-15 |
| 20/200-84 | SCHA.2888 | K918611 | DB-16 |
| 20/200-86 | SCHA.2532 | K957252 | DB-16 |
| 20/200-87 | 228.0087.10 | K957435 | DB-16 |
| 20/200-88 | SCHA.30502 | K202291 | DB-17 |
| 20/200-89 | SCHA.30503 | K956051 | DB-17 |
| 20/200-90 | SCHA.30504 | K202825 | DB-17 |
| 20/212-18 | D.910886 | K910886 | DB-16 |
| 20/212-19 | D.89322 | K89322 | DB-16 |
| 20/212-20 | D.915827 | K915827 | DB-16 |
| 20/212-21 | 20/947089 | K947089 | DB-17 |
| 20/212-22 | D.952378 | K952378 | DB-17 |
| 20/221-82 | D.14014 | K14014 | DB-16 |
| 20/221-82 | D.14014 | K915379 | DB-16 |
| 20/221-84 | D.89321 | K89321 | DB-16 |
| 20/221-84 | D.89321 | K923374 | DB-16 |
| 20/221-86 | D.919861 | K957254 | DB-16 |
| 20/221-87 | SPHB.4552 | K957436 | DB-16 |
| 20/221-88 | 20/202625 | K202625 | DB-17 |
| 20/221-89 | SP.30552 | K956052 | DB-17 |
| 20/221-90 | D.202826 | K202826 | DB-17 |
| 20/226-80 | D.950544 | K950544 | DB-17, DB-18 |
| 20/227-80 | DB.6/378 | K964572 | DB-17, DB-18 |
| 20/228-80 | D.952267 | K952267 | DB-17 |
| 20/228-82 | DO.203416 | K203416 | DB-17, DB-18 |
| 20/228-83 | DO.201826 | K200129 | DB-17, DB-18 |
| 20/229-80 | DB.181/31 | K964573 | DB-17 |
| 20/229-81 | D.964576 | K964576 | DB-17 |
| 20/229-82 | D.965723 | K965723 | DB-17, DB-18 |
| 20/229-83 | D.965765 | K965765 | DB-17 |

| REF. n° ORDER N° | REF. ANTIGUA OLD REF. | OEM OEM REF. | PAGINA PAGE |
|---------------------|--------------------------|-----------------|----------------|
| 20/230-10 | D.19167 | K19167 | DB-16, DB-17 |
| 20/231-19 | | K14083 | DB-16 |
| 20/231-20 | D.620182 | K620182 | DB-16 |
| 20/231-21 | D.19169 | K19169 | DB-16, DB-17 |
| 20/231-21 | D.19169 | K620153 | DB-16 |
| 20/231-22 | D.19177 | K19177 | DB-16, DB-17 |
| 20/231-80 | D.620085 | K620085 | DB-16 |
| 60/240-8 | 165 | K914441 | DB-11 |
| 60/240-18 | DO.210049 | K210049 | DB-11 |
| 60/240-19 | D.920522 | K920522 | DB-11 |
| 20/303-80 | 20/948393 | K948393 | DB-20 |
| 20/377-81 | DB.207666 | K207666 | DB-20 |
| 20/402-80 | D.13353 | K13353 | DB-18 |
| 20/404-80K | D.960595 | K960595 | DB-18 |
| 20/404-81K | D.962266 | K962266 | DB-18 |
| 20/404-82K | D.962269 | K962269 | DB-18 |
| 20/404-82K | D.962269 | K964542 | DB-18 |
| 20/417-80 | 20/954738 | K954738 | DB-18 |
| 20/417-81 | 20/945753 | K945753 | DB-18 |
| 20/418-80 | 20/963645 | K963645 | DB-18 |
| 20/419-80 | 20/963644 | K963644 | DB-18 |
| 20/422-80 | DO.202905 | K202905 | DB-18 |
| 20/422-81 | DO.945754 | K945754 | DB-18 |
| 20/423-80 | 20/200550 | K200550 | DB-18 |
| 20/423-81 | DO.945755 | K945755 | DB-18 |
| 20/442-2 | D.611261 | K611261 | DB-20 |
| 20/442-3 | D.611270 | K611270 | DB-20 |
| 20/443-3 | D.617006 | K617006 | DB-20 |
| 20/446-80 | D.907400 | K907400 | DB-19 |
| 20/446-81 | D.600875 | K600875 | DB-19 |
| 20/449-11 | D.947937 | K947937 | DB-20 |
| 20/449-12 | D.947941 | K947941 | DB-20 |
| 20/449-13 | D.947731 | K949731 | DB-20 |
| 20/449-80 | D.947940 | K947940 | DB-20 |
| 20/451-80 | 20/626873 | K626673 | DB-19 |
| 20/452-80 | 20/617157 | K617157 | DB-19 |
| 70/457-2 | LN10-2 | | DB-20 |
| 70/457-5 | LN10-5 | | DB-20 |
| 20/460-10 | 20/B1022 | K962984 | DB-19 |
| 20/460-11 | 20/B1023 | K962985 | DB-19 |
| 20/460-12 | D.19186 | K19186 | DB-19 |
| 20/460-12 | 20/B1024 | K962986 | DB-19 |
| 20/460-81 | 20/B1025 | K262214 | DB-19 |
| 20/461-10 | D.15638 | K623450 | DB-19 |
| 20/461-12 | D.623419 | K623419 | DB-19 |
| 20/462-10 | D.620076 | K620076 | DB-19 |
| 20/462-11 | D.620046 | K620046 | DB-19 |
| 20/462-25 | D.620167 | K620167 | DB-19 |
| 20/462-26 | D.32676 | K32676 | DB-19 |
| 20/463-10 | D.12459 | K24659 | DB-19 |
| 20/463-12 | D.19085 | K19085 | DB-19 |
| 20/470-72 | 20/262209 | K262209 | DB-19 |
| 20/470-73 | 20/262211 | K262211 | DB-19 |
| 20/470-74 | 20/262207 | K262207 | DB-19 |
| 20/470-80 | D.961725 | K961725 | DB-19 |
| 20/476-80 | D.15594 | K15594 | DB-19 |
| 20/477-80 | D.11598 | K11598 | DB-19 |
| 20/479-80 | D.33682 | K33682 | DB-19 |
| 20/491-80 | D.908071 | K908071 | DB-21 |
| 20/491-81 | D.915962 | K207722 | DB-21 |
| 20/491-81 | D.915962 | K915962 | DB-21 |
| 20/495-80 | D.965269 | K965269 | DB-21 |
| 20/495-81 | 20/260250 | K260250 | DB-21 |
| 20/496-80 | D.965270 | K965270 | DB-21 |
| 20/496-81 | 20/260254 | K260254 | DB-21 |
| 20/510-80 | D.83746 | K83746 | DB-20 |
| 20/530-80 | 20/912411 | K912411 | DB-20 |
| 20/570-206 | 20/957318 | K957318 | DB-22 |
| 20/574-15 | D.960750 | K960750 | DB-22 |
| 20/574-16 | D.964931 | K964931 | DB-22 |
| 20/575-206 | D.964935 | K964935 | DB-22 |
| 20/581-82 | D.923766 | K207721 | DB-21 |
| 20/581-82 | D.923766 | K923766 | DB-21 |
| 20/581-83 | D.929057 | K929057 | DB-21 |

Las referencias originales tienen un propósito identificativo.
Nuestras piezas no son originales.

Part numbers are quoted for reference purposes only.
Our parts and accessories are not original.



LISTA DE REFERENCIAS CRUZADAS (Ref. n°)
CROSS REFERENCES (Order N°)

| REF. n° ORDER N° | REF. ANTIGUA OLD REF. | OEM OEM REF. | PAGINA PAGE | REF. n° ORDER N° | REF. ANTIGUA OLD REF. | OEM OEM REF. | PAGINA PAGE |
|---------------------|--------------------------|-----------------|----------------|---------------------|--------------------------|-----------------|----------------|
| 20/640-206 | 20/962635 | K962635 | DB-22 | 62/933-3 | 54E.259/517 | K964218 | DB-26 |
| 20/640-207 | D.919048 | K919048 | DB-22 | 62/933-3 | 54E.259/517 | TAB118 | DB-26 |
| 20/640-208 | DO.307058 | K307945 | DB-22 | 62/934-1 | 54E.243/853 | K963791 | DB-26 |
| 20/640-209 | 20/949605 | K949605 | DB-22 | 62/934-1 | 54E.243/853 | K963931 | DB-26 |
| 20/640-210 | 20/916535 | K916535 | DB-22 | 62/934-1 | 54E.243/853 | TCB118 | DB-26 |
| 20/640-211 | 20/310386 | K310386 | DB-22 | 62/939-3 | 292E.130 | TLB117 | DB-26 |
| 20/660-2 | 20/944950 | K944950 | DB-23 | 62/939-4 | LU/TMB.124 | K964242 | DB-26 |
| 20/660-3 | 20/200464 | K200464 | DB-23 | 62/939-4 | LU/TMB.124 | TMB124 | DB-26 |
| 20/662-2 | 20/910538 | K910538 | DB-23 | 62/939-11 | 54E.258/190 | K964214 | DB-26 |
| 20/662-3 | 20/200465 | K200465 | DB-23 | 62/939-11 | 54E.258/190 | TMB111 | DB-26 |
| 20/663-3 | 20/944947 | K944947 | DB-23 | 62/939-14 | 54E.268/139 | K262028 | DB-26 |
| 20/680-80 | 20/203026 | K203026 | DB-20 | 62/939-14 | 54E.268/139 | TMB148 | DB-26 |
| 20/710-80 | D.900054 | K900054 | DB-24 | 62/939-36 | LU/TMB.107 | TMB107 | DB-26 |
| 20/710-81 | D.922634 | K922634 | DB-24 | 62/940-5 | LU.76458 | TOB153 | DB-26 |
| 20/719-80 | D.900055 | K900055 | DB-24 | 62/940-7 | LU.76796 | K963825 | DB-26 |
| 20/730-80 | D.912228 | K912228 | DB-24 | 62/940-7 | LU.76796 | TOB162 | DB-26 |
| 20/730-81 | D.907008 | K907008 | DB-24 | 62/940-9 | LU.76836 | K964215 | DB-26 |
| 20/735-80 | D.954646 | K954646 | DB-24 | 62/940-9 | LU.76836 | TOB110 | DB-26 |
| 20/740-80K | DB.169K2 | | DB-24 | 62/940-12 | LU.77139 | K262026 | DB-26 |
| 20/740-81K | DB.170K2 | | DB-24 | 62/940-12 | LU.77139 | TPB111 | DB-26 |
| 20/760-80 | 20/204558K | | DB-24 | 63/950-2 | 10/1808 | K203992 | DB-15 |
| 20/762-80 | D.2536 | | DB-24 | 63/950-81 | ET.54 | K19903 | DB-15 |
| 61/830-865 | SG10/UN | | DB-28 | 63/953-1 | 10/1699 | K300791/2 | DB-15 |
| 61/831-2 | DB.901C | K947556/7 | DB-28 | 20/962-80 | 20/929737 | K929737 | DB-15 |
| 61/831-3 | D.902 | K964819 | DB-28 | 68/1138-70 | AT19/72 | | DB-24 |
| 20/860-80 | 20/962479 | K962479 | DB-28 | 68/1138-95 | AT19/100 | | DB-24 |
| 20/860-81 | 20/947732 | K947732 | DB-28 | 68/1142-103 | AT25/110 | | DB-24 |
| 20/860-82 | 20/949207 | K949207 | DB-28 | 63/1882-3 | ET.58 | | DB-15 |
| 20/860-83 | 20/949208 | K949208 | DB-28 | 20/1912-22 | D.300190 | K300190 | DB-13 |
| 20/860-84 | 20/949210 | K949210 | DB-28 | 20/1912-23 | D.300189 | K300189 | DB-13 |
| 20/860-85 | 20/162148 | K962148/53 | DB-28 | 20/1913-22 | DO.260880 | K260880 | DB-13 |
| 20/870-8 | 20/303743 | K303743 | DB-29 | 20/1918-5 | D.300194 | K300194 | DB-13 |
| 20/871-7 | 20/303741 | K303741 | DB-29 | 20/1918-6 | D.300195 | K300195 | DB-13 |
| 20/872-8 | 20/302896 | K302896 | DB-29 | 20/1919-5 | DO.260911 | K260911 | DB-13 |
| 20/872-9 | 20/303870 | K303870 | DB-29 | 63/1931-5 | 10/W394 | | DB-13 |
| 62/910-1 | LU.22703/N | K908882 | DB-25 | 63/1931-10 | ET.1230/M | | DB-13 |
| 62/910-1 | LU.22703/N | K928643 | DB-25 | 63/1931-11 | ET.1162/M | | DB-13 |
| 62/911-2 | 54E.213/780 | UWB102 | DB-25 | 63/1934-5 | ET.131 | | DB-13 |
| 62/913-2 | 227E.541 | USB104 | DB-25 | 63/1955-207 | 10/12821 | K962763 | DB-13 |
| 62/914-1 | 227E.818 | UTB110 | DB-25 | 63/1955-380 | 10/12500 | K300192 | DB-13 |
| 62/915-1 | 189E.237 | UTB107 | DB-25 | 63/1955-382 | 10/12498 | K963886 | DB-13 |
| 62/919-1 | 37.LU.229 | K900136 | DB-25 | 63/1955-453 | 10/12336 | | DB-13 |
| 62/919-2 | 37.RB.408 | K908901 | DB-25 | 63/1955-472 | 10/12342 | | DB-13 |
| 62/919-17 | 205/040304 | 205/04034 | DB-25 | 63/1980-2 | 10/112-85 | | DB-29 |
| 62/919-22 | 505E.032 | | DB-25 | 63/1980-3 | 10/112-110 | | DB-29 |
| 62/919-80 | 37UCB612 | UCB100 | DB-25 | 70/1987-18 | 10/3225 | K773406 | DB-29 |
| 62/919-81 | 37UCB584 | UCB109 | DB-25 | 70/1987-20 | 10/3227 | K262711 | DB-29 |
| 62/920-4 | 15/1068 | K956426 | DB-25 | 63/1995-80 | ET.125 | | DB-15 |
| 62/920-10 | 15/1276 | K302424 | DB-25 | 70/2930-45 | 5870/10 | | DB-12 |
| 62/920-10 | 15/1276 | K307720 | DB-25 | 70/2930-51 | 5870/21 | | DB-12 |
| 62/920-24 | 15/1305 | K306549 | DB-25 | 70/2930-57 | 5870/22 | | DB-12 |
| 62/920-26 | 510.E.343 | K306549 | DB-25 | 70/2935-48 | MC5863 | | DB-12 |
| 62/920-27 | 510E324 | K956426 | DB-25 | 70/2935-54 | MC5856 | | DB-12 |
| 62/920-59 | 15/1067 | | DB-25 | 64/3102-30 | 3102-30 | | DB-27 |
| 62/920-87 | 510.E.344 | K925009 | DB-25 | 64/3102-42 | 3102-42 | | DB-27 |
| 62/923-1 | 54E.219/368 | ULB110 | DB-25 | 64/3102-42 | 3102-42 | | DB-27 |
| 62/930-3 | LUR/26278 | K957340 | DB-26 | 20/4000-37 | D.7020 | K303699 | DB-31 |
| 62/930-6 | K.957341 | K913007 | DB-26 | 20/4002-2 | D.7040 | K965652 | DB-30 |
| 62/930-6 | K.957341 | K957341 | DB-26 | 20/4015-2 | D.7042 | K965469 | DB-30 |
| 62/930-15 | K.308650 | K308650 | DB-26 | 20/4016-2 | D.7041 | K965470 | DB-30 |
| 62/931-3 | 54E.251/818 | TIB113 | DB-26 | 20/4028-2 | D.7025 | K303700 | DB-31 |
| 62/931-4 | 54E.255/952 | TIB114 | DB-26 | 20/4029-2 | D.7028 | K303703 | DB-31 |
| 62/931-5 | 54E.247/379 | K964185 | DB-26 | 20/4034-1 | D.7043 | K965484 | DB-30 |
| 62/931-5 | 54E.247/379 | TIB108 | DB-26 | 20/4035-1 | D.7044 | K965483 | DB-30 |
| 62/931-7 | 54E.243/590 | K964221 | DB-26 | 20/4036-1 | D.7045 | K965486 | DB-30 |
| 62/931-7 | 54E.243/590 | TJB103 | DB-26 | 20/4037-1 | D.7046 | K965485 | DB-30 |
| 62/931-9 | 54E.292/376 | K262025 | DB-26 | 20/4038-6 | D.7026 | K303702 | DB-31 |
| 62/931-9 | 54E.292/376 | TJB114 | DB-26 | 20/4039-6 | D.7027 | K303701 | DB-31 |
| 62/932-3 | 272E.394 | TEB132 | DB-26 | 20/4040-3 | D.7048/S | | DB-30 |
| 62/932-4 | 54E.244/973 | K964210 | DB-26 | 20/4041-5 | D.7048/F | | DB-30 |
| 62/932-4 | 54E.244/973 | TEB129 | DB-26 | 20/4043-2 | D.7024 | K303705 | DB-31 |
| 62/932-7 | 54E.268/462 | K262024 | DB-26 | 20/4045-3 | D.7023 | K303704 | DB-31 |
| 62/932-7 | 54E.268/462 | TEB144 | DB-26 | 20/4072-23 | | K965668 | DB-30 |
| 62/933-2 | 271E.735 | TAB125 | DB-26 | 20/4072-26 | D.7029 | K312000 | DB-31 |

Las referencias originales tienen un propósito identificativo.
Nuestras piezas no son originales.

Part numbers are quoted for reference purposes only.
Our parts and accessories are not original.



"THE RELIABLE SERVICE"



LISTA DE REFERENCIAS CRUZADAS (Ref. n°)
CROSS REFERENCES (Order N°)

| REF. n° ORDER N° | REF. ANTIGUA OLD REF. | OEM OEM REF. | PAGINA PAGE | REF. n° ORDER N° | REF. ANTIGUA OLD REF. | OEM OEM REF. | PAGINA PAGE |
|---------------------|--------------------------|-----------------|----------------|---------------------|--------------------------|-----------------|----------------|
| 20/4072-27 | D.7029/A | K303696 | DB-31 | | | | |
| 20/4073-16 | D.7032 | K303950 | DB-31 | | | | |
| 20/4074-3 | D.7050/S | | DB-30 | | | | |
| 20/4074-4 | D.7030 | K303707 | DB-31 | | | | |
| 20/4075-3 | D.7050/F | | DB-30 | | | | |
| 20/4075-4 | D.7031 | K303706 | DB-31 | | | | |
| 20/4077-1 | D.7049 | K965468 | DB-30 | | | | |
| 70/4110-4 | 13/1201 | | DB-29 | | | | |
| 70/4110-9 | 13/1200 | | DB-29 | | | | |
| 70/4110-10 | 13/1206 | | DB-29 | | | | |
| 70/4110-11 | 13/1207 | | DB-29 | | | | |
| 70/4110-12 | 13/1208 | | DB-29 | | | | |
| 70/4110-13 | 13/1209 | | DB-29 | | | | |
| 70/4112-2 | 13/1202 | | DB-29 | | | | |
| 70/4112-3 | 13/1203 | | DB-29 | | | | |
| 70/4112-4 | 13/1204 | | DB-29 | | | | |
| 70/4112-5 | 13/1205 | | DB-29 | | | | |
| 70/4170-19 | 13/1438LH | K303805 | DB-27 | | | | |
| 70/4170-20 | 13/1436RH | K303806 | DB-27 | | | | |
| 70/4170-21 | 13/1429 | K303755 | DB-27 | | | | |
| 70/4170-25 | 13/1443 | K260004 | DB-27 | | | | |
| 70/4170-84 | 13/1447 | K955435 | DB-27 | | | | |
| 70/4170-85 | 13/1445 | K773205/6 | DB-27 | | | | |
| 70/4170-86 | 6821 | K955448 | DB-27 | | | | |
| 60/4200-1 | | K307737 | DB-10 | | | | |
| 20/6300-80 | 20/V440 | | DB-20 | | | | |
| 20/6403-20 | 25/965215 | K965215 | DB-20 | | | | |
| 20/6403-80 | 20/965331 | K965331 | DB-20 | | | | |
| 20/6403-81 | 20/262161 | K262161 | DB-20 | | | | |
| 20/6500-98 | DA.098 | | DB-23 | | | | |
| 20/6500-99 | DA.099 | | DB-23 | | | | |
| 20/6500-100 | DA.100 | | DB-23 | | | | |
| 20/6500-101 | DA.101 | | DB-23 | | | | |
| 20/7613-1 | H.13066 | | DB-22 | | | | |
| 64/LA9002/L | LA9002/L | | DB-27 | | | | |
| 64/LA9002/SP | LA9002/SP | | DB-27 | | | | |

Las referencias originales tienen un propósito identificativo.
Nuestras piezas no son originales.

Part numbers are quoted for reference purposes only.
Our parts and accessories are not original.



INDEX

| | | | |
|---|------------------|--|------------------|
| Alternadores | 48 | <i>Alternators</i> | 48 |
| Amortiguadores | 52 | <i>Brakes</i> | 30 |
| Asiento | 54 | <i>By-pass hoses</i> | 33 |
| Bombas de aceite | 9 | <i>Cab door locks and handles</i> | 51 |
| Bombas de agua y juego de reparación | 11 | <i>Cab glass</i> | 55-57 |
| Bombas gas-oil | 9 | <i>Clutch assemblies and plates</i> | 25-29 |
| Bombas hidráulicas | 43-44 | <i>Coolant manifolds</i> | 14 |
| Cables de cuentahoras | 24 | <i>Cooling hoses</i> | 13 |
| Caja niveladora | 46 | <i>Crankshafts and related parts</i> | 3 |
| Calentadores | 8 | <i>Cross referenes</i> | (see CIHE 42-57) |
| Camisas | 5 | <i>Cylinder head parts</i> | 7 |
| Cigüeñales y piezas relacionadas | 3 | <i>Drive cables</i> | 24 |
| Cilindros principal y receptor | 29-30 | <i>Engine gasket sets</i> | 8 |
| Colectores de refrigeración | 14 | <i>Fan belts</i> | 12 |
| Correas del ventilador | 12 | <i>Filters</i> | 14-18 |
| Cristal de cabina | 55-57 | <i>Front axle parts</i> | 24-27 |
| Crucetas (Eje delantero) | 37 | <i>Fuel pump</i> | 9 |
| Eje delantero | 32-37 | <i>Fuel tank caps</i> | 12 |
| Eje trasero | 31 | <i>Gas struts</i> | 52 |
| Embragues | 25-29 | <i>Glazing rubber</i> | 54 |
| Equipo de cilindro | 4 | <i>Heater plug</i> | 8 |
| Escobillas y motores del limpia-parabreisas | 53 | <i>Hydraulic</i> | 45 |
| Estabilizadores y coponentes | 47 | <i>Hydraulic pumps</i> | 43-44 |
| Faros de trabajo | 22 | <i>Indicators</i> | 24 |
| Filtros | 14-18 | <i>Injector nozzles</i> | 10 |
| Freno | 30 | <i>Instruments (miscellaneous)</i> | 12 |
| Goma para cristales de cabina | 54 | <i>Items (miscellaneous)</i> | 24 |
| Hidráulicos | 45 | <i>Levelling box assembly</i> | 46 |
| Instrumentos diversos | 24 | <i>Levelling box assemblies</i> | 46 |
| Interruptores varios | 23 | <i>Lighting</i> | 20-22 |
| Juego de motor completo | 6 | <i>Liners</i> | 5 |
| Juegos de segmentos | 6 | <i>Master and slave cylindres</i> | 29-30 |
| Juntas de motor | 8 | <i>Mufflers (vertical)</i> | 19 |
| Lista de referencias cruzadas | (Ver CIHE 42-57) | <i>Oil pumps</i> | 9 |
| Luces | 20-22 | <i>Overhaul kits</i> | 6 |
| Manetas puertas | 51 | <i>Paint</i> | 51 |
| Manguitos de bomba de agua | 13 | <i>Pistons</i> | 5 |
| Manguitos radiador | 13 | <i>Pistons, ring sets and liners</i> | 4 |
| Motores de arranque | 49-50 | <i>Radiator cap</i> | 12 |
| Pintura | 51 | <i>Rear axle parts</i> | 31 |
| Pistones | 5 | <i>Ring sets</i> | 6 |
| Repuestos para válvula y culatas | 7 | <i>Seats</i> | 54 |
| Rótulas y acoples de dirección | 38-42 | <i>Stabilisers and components</i> | 47 |
| Silenciosos (Vertical) | 19 | <i>Starter motors</i> | 49-50 |
| Termostatos | 12 | <i>Studs and screws (rear wheels)</i> | 37 |
| Tapón radiador | 12 | <i>Switches (miscellaneous)</i> | 23 |
| Tapón deposito | 12 | <i>Thermostats</i> | 12 |
| Toberas | 10 | <i>Tie rods and sockets</i> | 38-42 |
| Tornillos y tuercas (Llanta trasera) | 37 | <i>Tractors and engine application chart</i> | 2 |
| Tractores y motores, rabla de aplicaciones | 2 | <i>Universal joints</i> | 37 |
| Unidad de intermitencia | 24 | <i>Water pumps and repair kits</i> | 11 |
| | | <i>Wiper motors and blades</i> | 53 |
| | | <i>Work lights</i> | 22 |

Las referencias originales tienen un propósito identificativo.
Nuestras piezas no son originales.

Part numbers are quoted for reference purposes only.
Our parts and accessories are not original.



TRACTORES Y MOTORES, TABLA DE APLICACIONES
TRACTORS AND ENGINE APPLICATION CHART
CASE-IH EUROPE
CIH-1 / CIH-57

| Tractores Tractors | Motor Engine | Tractores Tractors | Motor Engine | Tractores Tractors | Motor Engine |
|---|--------------------------|--------------------------|-------------------------|----------------------------|-------------------------------------|
| D.217, D.217S, D.219 | DD.74 (2 cil./cyl.) | 856XL | DT.239 (4 cil./cyl.) | MAXXUM 5140 | 6T-590 (6 cil./cyl.) |
| D.324, D.326 | DD.111 (3 cil./cyl.) | 824, 844 | D.246 (4 cil./cyl.) | MAXXUM 5150 | 6T-690 (6 cil./cyl.) |
| 323 | DU.111 (3 cil./cyl.) | 844S, 845S, 845XL | D.268 (4 cil./cyl.) | MAGNUM 7110, 7120 | 6T-830 (6 cil./cyl.) |
| D.436, DTD.5 | DD.148 (4 cil./cyl.) | 756, 946, 955 | D.310 (6 cil./cyl.) | MAGNUM 7130 | 6T-830 / 6CT-830 (6 cil./cyl.) |
| D.439 | DU.148D (4 cil./cyl.) | 956, 1046, 1055, 1056 | D.358 (6 cil./cyl.) | MAGNUM 7140 | 6TA-830 / 6CTA-830 (6 cil./cyl.) |
| 353, 383, 423, 433, 440, 453, 533, 540 | D.155 (3 cil./cyl.) | 1246, 1255 (+ XL) | DT.358 (6 cil./cyl.) | | |
| 523, 553, 633, 640 | D.179 (3 cil./cyl.) | 1455 (+ XL) | DT.402 (6 cil./cyl.) | MAGNUM 7210, 7220, 7230 | 6T-830 (6 cil./cyl.) |
| 554, 624, 644, 645, 654, 733, 740 | D.206 (4 cil./cyl.) | MAXXUM 5120 | 4T-390 (4 cil./cyl.) | MAGNUM 7240 | 6TI-830 (6 cil./cyl.) |
| 724, 743, 744, 745, 833, 840, 846 | D.239 (4 cil./cyl.) | MAXXUM 5130 | 6-590 (6 cil./cyl.) | MAGNUM 7250 | 6TIR-830 (6 cil./cyl.) |

CASE-IH ENGLAND
CIHE-1 / CIHE-56

| Tractores Tractors | Motor Engine | Tractores Tractors | Motor Engine | Tractores Tractors | Motor Engine |
|----------------------------|---------------------------|-----------------------------|--------------------------|----------------------------------|--------------------------|
| 275, 276, 354 | BD.144 (4 cil. / cyl.) | 454, 484, 485, 495, 3220 | D.179 (3 cil. / cyl.) | 574, 674, 684, 685, 695, 4210 | D.239 (4 cil. / cyl.) |
| 374, 384, 414, 434, 444 | BD.154 (4 cil. / cyl.) | 474, 584, 585, 595, 3230 | D.206 (4 cil. / cyl.) | 784, 785, 795, 4220 | D.246 (4 cil. / cyl.) |
| 385, 395, 3210 | D.155 (3 cil. / cyl.) | 475 | Perkins A4.212 | 884, 885, 895, 4230 | D.268 (4 cil. / cyl.) |

Las referencias originales tienen un propósito identificativo.
 Nuestras piezas no son originales.

Part numbers are quoted for reference purposes only.
 Our parts and accessories are not original.



CIGÜEÑALES Y PIEZAS RELACIONADAS
CRANKSHAFTS & RELATED PARTS

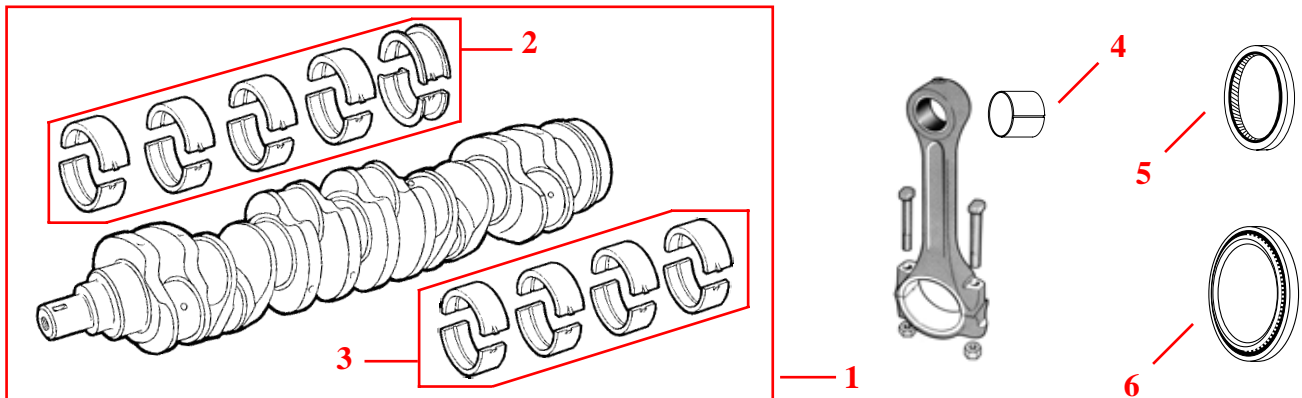

| Fig. | 1 | 2 | 3 | 4 | 5 | 6 | |
|--|-----------------|--|---|---|---------------------------------|----------------------------------|---------------------------------|
| Tractores Tractors | Motor Engine | Juego cigüeñal Crankshaft kit | Cojinete de bancada Main bearing | Cojinete de biela Con. rod. bearing | Buje biela Small end bush | Retén delantero Front seal | Retén trasero Rear seal |
| D.217, D.217S, D.219, D.324, D.326, 323, D.436, D.439, D.440 | | | | 25/9-16 (1x 710327R11) Pareja / Pair | | | |
| 353, 383, 423, 433, 453, 533, 440, 540 | D.155 | | 25/2-23 (1 x 3055129R21 3 x 3055130R21) | 25/3-23 (3 x 3055351R91) | | | |
| 523, 553, 633, 640 | D.179 | | | | 25/28-14 (3132018R2) | | |
| 554, 624, 644, 654, 733, 740 | D.206 | 25/1-55 (3132968R93, 1329196C1) | | 25/3-24 (4 x 3055351R91) | | | |
| 724, 743, 744, 745, 824, 833, 840 | D.239 | 25/1-56 (3144626R92) | | | | | |
| 856XL | DT.239 | | 25/2-24 (1 x 3055129R21 4 x 3055130R21) | 25/3-34 (4 x 3132101R91) | | | |
| 824, 844 | D.246 | 25/1-56 (3144626R92) | | 25/3-24 (4 x 3055351R91) | | 25/11-18 (3228401R91) | 25/13-16 (3138701R91) |
| 844S, 845S, 844, 845XL | D.268 | | | 25/3-25 (4 x 3144688R92) | 25/28-14 (3132018R2) | | |
| 946, 955 | D.310 | | | 25/3-26 (6 x 3055351R91) | | | |
| 955, 956, 1046, 1055, 1056 | D.358 | | | | | | |
| 1246, 1255 (+XL) | DT.358 | | 25/2-26 (1 x 3055129R21, 6 x 3055130R21) | 25/3-46 (6 x 3132101R91) *Largeur* / Width 32mm | | | |
| 1455 (+XL) | DT.402 | | | 25/3-47 (6 x 3218422R91) *Largeur* / Width 30mm | | | |

Cojinetes de bancada y de biela disponibles en las siguientes sobremedidas 0,010"- 0,020"- 0,030". Consultar.
Main and con-rod bearings are available in 0,010"- 0,020"- 0,030" oversizes. Please ask.

Retenes de cigüeñal / Crankshaft seals

Mot. D.155, 206, 310, 179, 239,
246, 268, 310, 358, DT.239,
DT.358, DT.402

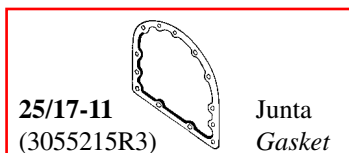

Juego 4 piezas con retén delantero
Kit of 4 parts incl. front seal

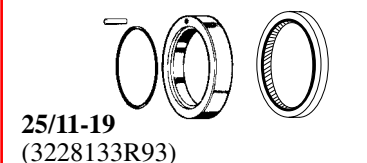

Polea para cigüeñal
Crankshaft pulley

25/59-8
(3138834R1)

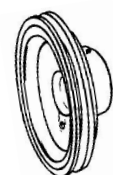

644, 654, 724, 733, 740, 743, 743XL, 744,
745S, 745XL, 824, 833, 840, 844, 844XL,
844S, 845, 845XL, 940

Las referencias originales tienen un propósito identificativo.
Nuestras piezas no son originales.

Part numbers are quoted for reference purposes only.
Our parts and accessories are not original.



**EQUIPO DE CILINDRO
PISTONS, RING SETS & LINERS**

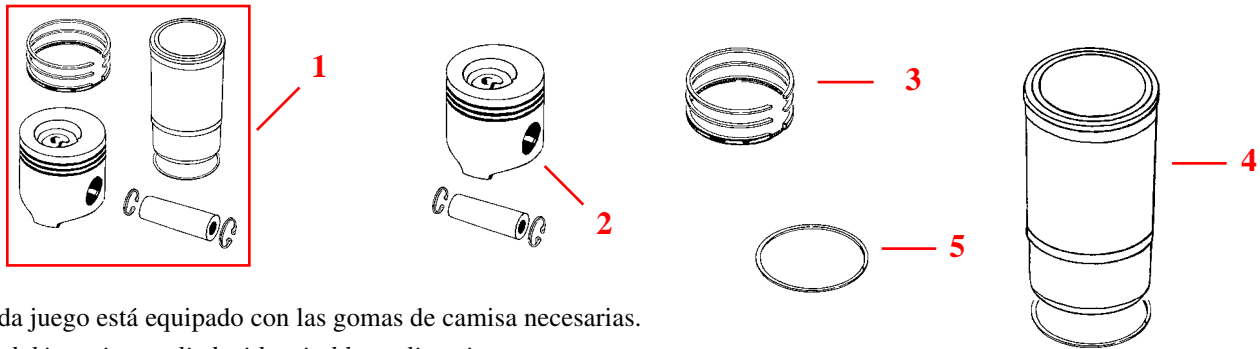

Cada juego está equipado con las gomas de camisa necesarias.

Each kit set is supplied with suitable sealing rings.

| Fig. | | | 1 | 2 | 3 | 4 | 5 |
|--|---------------------------|----------------------|---|---|--|--------------------------------|---|
| Tractores Tractors | Motor Engine | Diámetro Diameter | Juego Kit set | Pistón Piston | Juego de segmentos Ring set | Camisa Liner | Juntas tóricas Sealing ring |
| D.212, D.214S, D.215, DLD.2 D.320S, D.322, DED.3 D.430S, D.432, D.440, DGD.4 | DD.66 DD.99 DD.132 | Ø 82,55mm | 25/31-115 (R099KS) | | | | |
| D.217, D.217S, D.219 (2 cyl.), D.324, D.326, 323 (3 cil./ cyl.) | DD.74 DD.111 DU.111 | Ø 87,3mm | 25/31-111 (R111KS) (A) | | 25/32-113 | | 25/38-113 |
| D.436, D.439, DTD.5 (4 cil./ cyl.) | DD.148 DU.148D | Ø 87,3mm | 25/31-112 (R148KS) | | | 25/35-112 | 25/38-112 |
| 353, 383, 423, 433, 453, 533, 440, 540 (3 cil./ cyl.) | D.155 | Ø 98,4mm | 25/31-62 (3218758R95) Non/ Not AL FIN | 25/33-62 (B.3362) Non/ Not AL FIN | 25/34-65 (3139594R91) AL FIN 3 segm./ rings ----- 25/34-62 (3218416R92) 3 segm./ rings ----- 25/34-60 (3059262R92) 4 segm./ rings AL FIN 1 ^{er} cónico 1 st wedged ring | 25/35-62 (3139587R3) | 25/38-62 (3228344R1) Ø 5,0mm ----- 25/38-63 (3228348R1) Ø 4,7mm |
| 554, 624, 644, 645, 654, 733, 740 (4 cil./ cyl.) | D.206 | | 25/31-64 (3139586R95) AL FIN (B) | 25/33-64 (B.3364) AL FIN | | | |
| 946, 955 (6 cil./ cyl.) | D.310 | | 25/31-63 (3218759R95) Non/ Not AL FIN | 25/33-63 (B.3363) Non/ Not AL FIN | | | |
| 523, 553, 633, 640 (3 cil./ cyl.) | D.179 | | 25/31-65 (3139591R96) AL FIN (C) | 25/33-65 (B.3365) AL FIN | | 25/35-63 (3139592R4) | |
| 684, 724, 743, 744, 745, 833, 840 (4 cil./ cyl.) | D.239 | | 25/31-113 (3144516R97) | | | | |
| 955, 956, 1046, 1055, 1056 (6 cil./ cyl.) | D.358 | | | | | | |
| 856XL (4 cil./ cyl.) | DT.239 | | | | | | |
| 1246, 1255 (+XL) (6 cil./ cyl.) | DT.358 | | | | | | |
| 824, 844 (4 cil./ cyl.) | D.246 | Ø 100mm | 25/31-66 (3218668R94) | 25/33-66 (B.3366) | 25/34-66 (3218669R91) | 25/35-66 (3144682R3) | |
| 844S, 845S, 845XL, 884 (4 cil./ cyl.) | D.268 | | 25/31-67 (3218461R95) AL FIN | 25/33-67 (B.3367) AL FIN | 25/34-67 (3144977R91) AL FIN | | |
| 1455 (+XL), YUMBO 650, HD.530 (6 cil./ cyl.) | DT.402 | | 25/31-114 (3218915R95) AL FIN | | | | |

(A) : Montaje para Manitou / Fits Manitou MB 15, 16, 20, 25 (Modelos antiguos/ 1st series),
20S, 25S, MC15, 20, 25, 20A, 25A, 15ML, 15E, 20E

(B) : Carrera / Stroke : 111,1 mm

(C) : Carrera / Stroke : 128,5 mm

Las referencias originales tienen un propósito identificativo.
Nuestras piezas no son originales.

Part numbers are quoted for reference purposes only.
Our parts and accessories are not original.



PISTONES
PISTONS

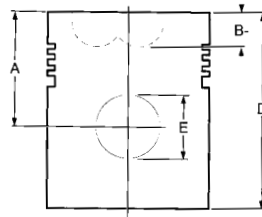
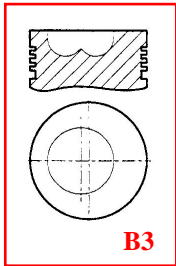

- A : Altura de compresión (mm)
Compression height (mm)
- B : Profundidad cámara de combustión (mm)
Combustion bowl depth (mm)
- D : Longitud total (mm)
Overall length (mm)
- E : Diámetro bulón (mm)
Gudgeon pin diameter (mm)

| Referencia References | Motores Engines | Ø pistón Bore dia. | Tipo Type | Número de aros N° of Rings | Alfín Al-fin | A | B | D | E | | |
|--------------------------|-----------------------|-----------------------|--------------|-------------------------------|-----------------|-------|-------|-----------|-------|-------|--------|
| 25/33-62 | D.155, D.206 D.310 | 98.42 | B3 | 3 | | 67.00 | 19.90 | 101.50 | 36.00 | | |
| 25/33-64 | | | | | Sí Yes | | | 107.00 | | | |
| 25/33-63 | D.179, D.239 D.358 | | | | | | | 101.50 | | | |
| 25/33-65 | | | | | Sí Yes | | | 107.00 | | | |
| 25/33-66 | D.246 | | | | 100.00 | | | | | 22.30 | 107.00 |
| 25/33-67 | D.268 | | | | | | | Sí Yes | | 24.00 | |

CAMISAS
LINERS

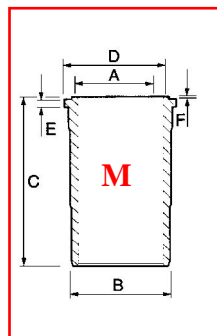

- A : Diámetro pistón (mm) / *Nominal bore diameter (mm)*
- B : Diámetro exterior (mm) / *Outside diameter (mm)*
- C : Longitud total (mm) / *Overall length (mm)*
- D : Diámetro pestaña (mm) / *Flange diameter (mm)*
- E : Anchura pestaña (mm) / *Flange width (mm)*
- F : Altura cortafuego (mm) / *Fire lip height (mm)*

















| Referencia References | Tipo Type | A | B | C | D | E | F |
|--------------------------|--------------|-------|--------|--------|--------|------|------|
| 25/35-62 | M | 98.42 | 110.75 | 201.10 | 119.00 | 7.70 | 1.10 |
| 25/35-63 | | | | 216.10 | | | |
| 25/35-66 | | | | 100.00 | | | |

Las referencias originales tienen un propósito identificativo.
Nuestras piezas no son originales.

Part numbers are quoted for reference purposes only.
Our parts and accessories are not original.



JUEGOS COMPLETOS DE SEGMENTOS
RING SETS

| Referencia References | Motores Engines | Ø pistón Bore dia. | | | | |
|--------------------------|---|-----------------------|--|--|--|--|
| 25/34-60 | | 98.42mm |  MK1 3.00 |  N1 3.17 |  P1 3.17 |  BEH 4.76 |
| 25/34-62 | D.155, D.206, D.310, D.179, D.239, D.358 | |  CP1 3.17 |  CT2 2.38 |  CBEH 4.76 | |
| 25/34-65 | | |  CK1 3.00 |  CT2 2.38 |  CBEH 4.76 | |
| 25/34-66 | D.246 | 100.00mm |  CP1 3.17 |  CT2 2.38 |  CBEH 4.76 | |
| 25/34-67 | D.268 | |  CK1 3.00 |  CT2 2.38 |  CBEH 4.76 | |

- BEH : Rebajado con muelle helicoidal / *Bevelled edge with helical coil spring*
- CBEH : Cromado y rebajado con muelle helicoidal / *Chrome plated bevelled edge with helical coil spring*
- CP1 : Rectangular cromado / *Chrome plated parallel faced*
- CK1 : Trapezoidal dos caras (Cromado exterior) / *Chrome plated keystone*
- CT2 : Exterior cónico cromado con rebaje interior superior / *Chrome plated taper faced internally stepped top*
- MK1 : Trapezoidal ambos lados con recubrimiento de molibdeno en cara exterior / *Molybdenum coated keystone*
- N1 : Tipo "Napier" o "Pico de águila" / *Napier - externally stepped bottom with single hook*
- P1 : Rectangular / *Parallel faced plain*

JUEGO DE MOTOR COMPLETO
OVERHAUL KITS

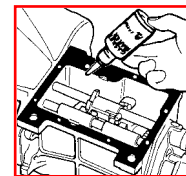
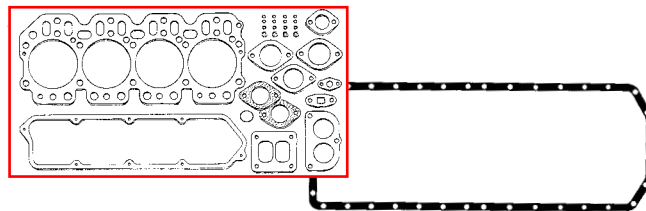
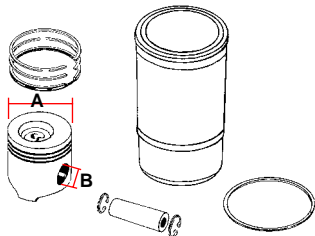

Se incluye : Juego de retenes, juego de juntas superior, junta del cárter y una lata de "Formajoint".
Included : kit sets with suitable sealing rings, top gasket set, sump gasket, one "Formajoint" can.

| Tractores Tractors | Motor Engine | Ø pistón Bore | Ø eje Pin Ø | Ref. Order N° | OEM |
|--|-----------------|------------------|----------------|------------------|-----------|
| 353, 383, 423, 433, 440, 453, 533, 540 | D.155 | 98.42mm | 36.00mm | 25/30-120 | 25/586K3 |
| 523, 553, 633, 640 | D.179 | | | 25/30-123 | 25/591K3 |
| 554, 624, 644, 645, 654, 733, 740 | D.206 | | | 25/30-121 | 25/586K4 |
| 684, 724, 743, 744, 745, 833, 840, 846 | D.239 | | | 25/30-124 | 25/591K4 |
| 856XL | DT.239 | | | 25/30-126 | 25/516K4 |
| 844S, 845S, 845XL, 884 | D.268 | 100.00mm | | 25/30-129 | 25/461K4 |
| 756, 946, 955 | D.310 | 98.42mm | | 25/30-122 | 25/586K6 |
| 955, 956, 1046, 1055, 1056 | D.358 | | | 25/30-125 | 25/591K6 |
| 1246, 1255 (+XL) | DT.358 | | | 25/30-127 | 25/516K6 |
| 824, 844 | D.246 | | | 100.00mm | 25/30-128 |

Las referencias originales tienen un propósito identificativo.
Nuestras piezas no son originales.

Part numbers are quoted for reference purposes only.
Our parts and accessories are not original.



REPUESTOS PARA VÁLVULAS Y CULATAS
CYLINDER HEAD PARTS

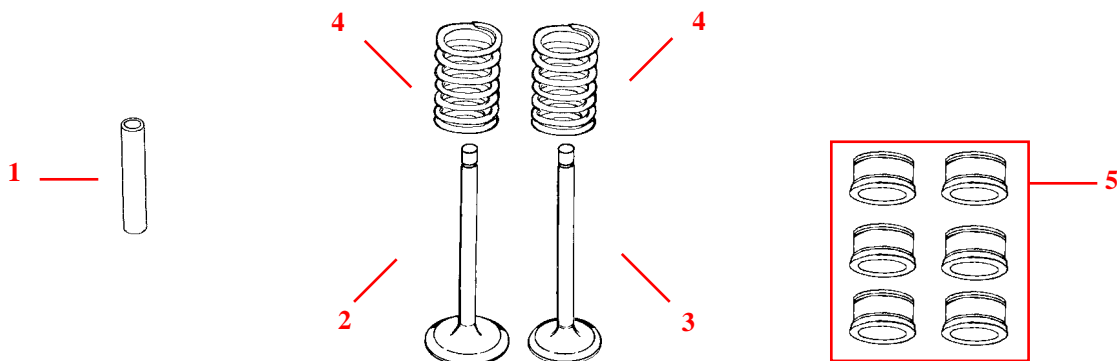

| Fig. | 1 | 2 | 3 | 4 | 5 |
|--|--------------------------------|--|---------------------------------|--------------------------------|--------------------------------|
| Tractores Tractors | Guia de válvula Guide | Válvula adms. Inlet valve | Válvula escape Exhaust valve | Muelle Spring | Retén Seal |
| 353, 383, 423, 433, 440, 453, 523, 533, 540, 553, 554, 624, 633, 640, 644, 654, 724, 733, 740, 743, 744, 745, 824, 833, 840, 844, 844S, 845S, 845, 946, 955, 956, 1046, 1055, 1056, 1246, 1255, 1455 (+XL) | 25/41-16 (3055022R2) | 25/42-23 (3055055R2, 3059459R1) | 25/43-23 (3055056R2) | 25/45-15 (3055060R1) | 25/47-6 (3218399R91) |
| 856XL | | | - | | |

LOCTITE *Permatex*

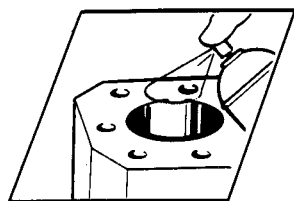

Para mantenimiento y reparación (ver catalogo 1)
For maintenance and repair (see part 1)

Las referencias originales tienen un propósito identificativo.
Nuestras piezas no son originales.

Part numbers are quoted for reference purposes only.
Our parts and accessories are not original.



**JUNTAS DE MOTOR
ENGINE GASKET SETS**

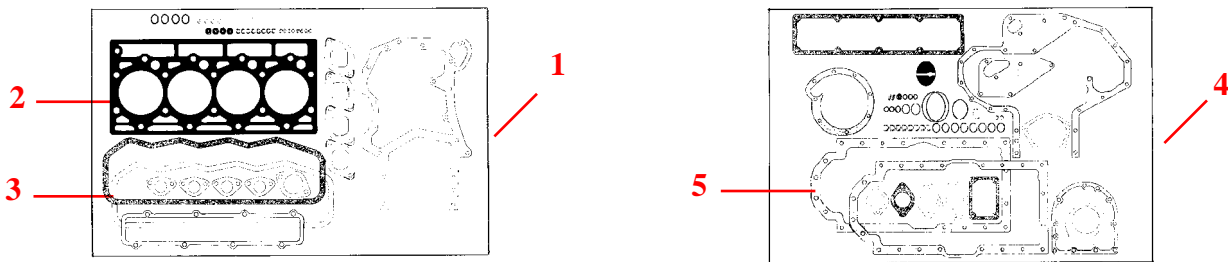

Los retenes delanteros y traseros no estan incluidos.
Front and rear seals are not included

| Fig. | 1 | 2 | 3 | 4 | 5 |
|--|--|----------------------------------|---|---|--|
| Tractores Tractors | Juego de juntas superior Top gasket set | Junta culata Cyl. head gasket | Junta balancines Rocker cover gasket | Juego de juntas inferior Bottom gasket set | Junta carter Sump gasket |
| D214S, DLD2, D212, D214, D215 (2 cyl.) | 25/71-100 (3051138R92) | | | | |
| DED-3, D320S, D322 (3 cyl.) | 25/71-102 (3051142R92) | | | | |
| D430S, D432, D440, DGD4 (4 cyl.) | 25/71-103 (3051146R92) | | | | |
| D217F, D217S, D219 (2 cyl.) | 25/71-101 (3051140R92) | | | | |
| D.324, D.326, 323 (3 cil. / cyl.) | 25/71-94 (3051144R92) | | | | |
| D.436, D.439, DTD.5 (4 cil. / cyl.) | 25/71-95 (3051148R92) | | | | |
| 353, 383, 423, 433, 440, 453, 523, 533, 540, 553, 633, 640 (3 cil. / cyl.) | 25/71-48 (3136798R99) | 25/73-48 (3228361R2) | 25/74-27 (3138641R1) | 25/72-48 (3136802R99) | 25/75-48 (3055160R3) |
| 554, 624, 644, 654, 724, 733, 740, 743, 744, 745, 824, 833, 840, 844, 844S, 845S, 845XL, 856XL (4 cil. / cyl.) | 25/71-49 (3136799R99, 1967014C1) | 25/73-49 (3228362R2) | 25/74-28 (3138642R2) | 25/72-49 (3136813R99, 1967011C1) | 25/75-49 (3055161R3) 25/75-51 (3144697R2) (844S, 844XL, 845S, 845XL) |
| 946, 955, 956 1046, 1055, 1056 (+XL) (6 cil. / cyl.) | 25/71-50 (3136801R99) | 25/73-50 (3228019R2) | 25/74-29 (3138688R2) | 25/72-50 (3136817R99, 1967013C1) | 25/75-50 (3055987R93) |
| 1246, 1255, 1455 (+XL), YUMBO 650, HD.530 (6 cil. / cyl.) | | | | | |

CALENTADORES / HEATER PLUG

25/60-13
(0250.200.021)
(3054716R91)
M18 x 1,5 9,5V

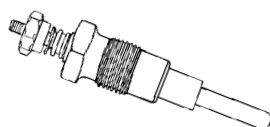

Mot. DD.111, DU.111,
DD.148, DU.148 Engine

Las referencias originales tienen un propósito identificativo.
Nuestras piezas no son originales.

Part numbers are quoted for reference purposes only.
Our parts and accessories are not original.



BOMBAS DE ACEITE
OIL PUMPS

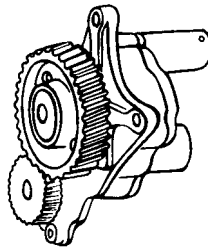

| Tractores Tractors | Motor Engine | Bomba de aceite Oil pump | OEM |
|--|---------------------------|-----------------------------|------------|
| 353, 423, 433, 440, 453, 533, 540 | D.155 (3 cil. / cyl.) | 25/90-35 | 3136429R95 |
| 523, 553, 633, 640 | D.179 (3 cil. / cyl.) | | |
| 554, 624, 644, 645, 654, 733, 740 | D.206 (4 cil. / cyl.) | 25/90-36 | 3136430R95 |
| 644, 856XL (96) | | 25/90-37 | 3136431R95 |
| 724, 743, 743XL, 744, 745S, 745XL, 833, 840, 846, 940 | D.239 (4 cil. / cyl.) | 25/90-36 | 3136430R95 |
| 856XL | DT.239 (4 cil. / cyl.) | 25/90-38 | 3136432R95 |
| 824 | D.246 (4 cil. / cyl.) | 25/90-36 | 3136430R95 |
| 844, 844S, 844XL, 845, 845XL | D.268 (4 cil. / cyl.) | | |
| 756, 946, 955, 955XL | D.310 (6 cil. / cyl.) | 25/90-39 | 3136433R95 |
| 956, 956XL, 1046, 1055, 1055XL, 1056, 1056XL | D.358 (6 cil. / cyl.) | | |
| 1246, 1255, 1255XL | DT.358 (6 cil. / cyl.) | 25/90-38 | 3136432R95 |
| 1455, 1455XL | DT.402 (6 cil. / cyl.) | | |
| MX90, 5120 | 4-390 | 25/90-43 | J930336 |
| MX100, MX110, MX120, MX135, 5130, 5130E, 5140, 5140E, 5150, 5150E | 6-590, 6T-590, 6TA-590 | 25/90-40 | J930337 |
| 7110, 7120, 7130, 7140, 7210, 7220 | 6T-830 (6 cil. / cyl.) | 25/90-41 | J930338 |

BOMBAS GAS-OIL
FUEL PUMPS

25/100-24
(3132697R92,
B503521)

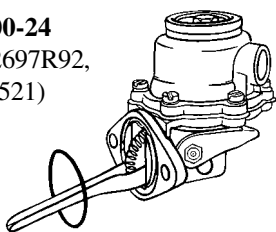

554, 624, 633, 644, 645, 654,
724, 733, 740, 743, 744, 745,
756, 833, 840, 844S, 844XL,
845S, 845XL, 846, 856XL, 946,
955, 956, 1046, 1055, 1056,
1246, 1255 (+XL), 1455 (+ XL)
Con bomba inyección CAV
With CAV injection pump

25/101-24
(3136002R91)



Juego de reparación
Repair kit

25/100-35
(J904374,
J928143)

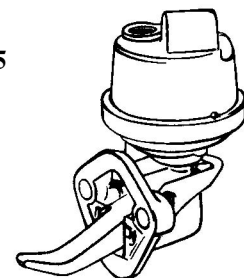

Maxxum
5120, 5130, 5140, 5150

Las referencias originales tienen un propósito identificativo.
Nuestras piezas no son originales.

Part numbers are quoted for reference purposes only.
Our parts and accessories are not original.



**TOBERAS
INJECTOR NOZZLES**

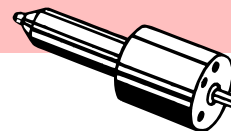
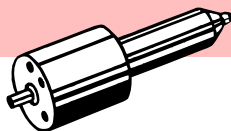

| Tractores Tractors | Presión Flow | Tobera Inj. nozzle | Nº tobera Nº on the injector nozzle |
|--|-----------------|----------------------------------|---|
| D.212, D.214, D.215, D.217F, D.219, D.320, D.322, D.324, D.326, D.430, D.432, D.436, D.439, D.440 | 150 bars | 25/117-54 (718383R2) | DNOSD1550 |
| Mot. D.155, D.179, D.206, D.310, 433, 533, 633, 644, 733, 955, (⇄ 10/79) Engines | | 25/117-55 (3218249R93) | DLLA150S716 |
| 353, 383, 423, (Mot. D.155 Engine) 12/67 ⇄ 2/75, 433 453 (Mot. D.155 Engine) 7/71 ⇄ 3/75, 523 (Mot. D.179 Engine) 12/67 ⇄ 12/71, 553 (Mot. D.179 Engine) 3/72 ⇄ 1/74, 554 (Mot. D.179 Engine) 7/71 ⇄ 3/75, 624 (Mot. D.206 Engine) 12/67 ⇄ 12/71, 633 (Mot. D.179 Engine) ⇄ 4/76, 654 (Mot. D.206 Engine) 3/72 ⇄ 12/74, 644, 724, 824, 946 | 205 bars | 25/117-56 (3055426R91) | 433270120 DLLA150S2641 |
| 433, 533, 633, 644, 733 (Mot. D.155, D.179, D.206 Engines) 11/79, 955 (Mot. D.310 Engine) 11/79⇄ | 225 bars | 25/117-53 (3218248R2) | 433271838 DLLA150S836 |
| 544,574 (Mot. D.239 Engine) 1/72⇄7/74, 724, 824, 834 (Mot. D.239, D.246 Engines) ⇄2/74, 1046, 1246, 744, 844, 844S | 205 bars | 25/117-57 (3055428R92) | 433271180 DLLA150S417 |
| 743, 745 (Mot. D.239 Engine) 9/80 ⇄, 744 (Mot. D.239 Engine) 5/79 ⇄8/80, 844, 844S, (Mot. D.246, D.268 Engines) 5/79⇄, 833, 833S, 955, 1055 (Mot. D.358 Engine) 11/79⇄, 1246 (Mot. DT.358 Engine) 5/79⇄, 856 XLA, 956, 956XLA, 1056XLA | 225 bars | 25/117-52 (3218251R2) | 433271849 DLLA150S815 DLLA150S690 |
| 1255, 1455 (Mot. DT.358, DT.402 Engines) 9/80⇄ | 225 bars | 25/117-58 (3218255R2) | 433271834 DLLA150S843 |
| MAXXUM 5120 | | 25/117-59 (J909476) | 433171074 DLLA155P74 |
| MAGNUM 7120, 7130 | 205 bars | 25/117-60 | 433171104 DLLA150P115 |
| MAGNUM 7140 | 205 bars | 25/117-61 | 433171121 DLLA150P133 |

Las referencias originales tienen un propósito identificativo.
Nuestras piezas no son originales.

Part numbers are quoted for reference purposes only.
Our parts and accessories are not original.



BOMBAS DE AGUA Y JUEGO DE REPARACIÓN
WATER PUMPS & REPAIR KITS

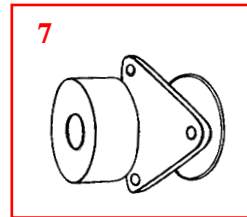
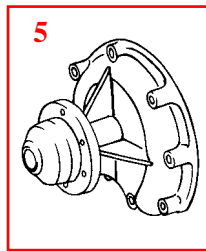
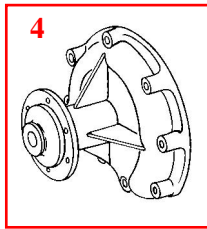
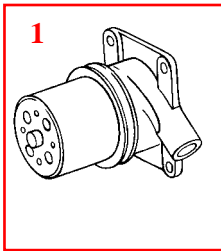

Todos tractores / All tractors

25/133-1
(R322004K)

Estopada
Water pump seal

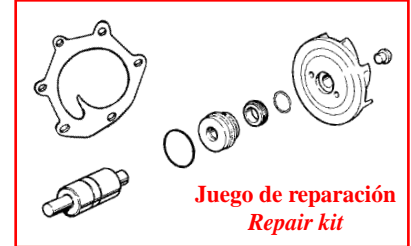
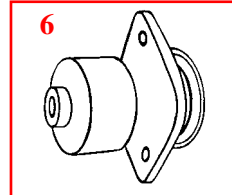
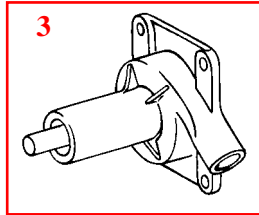
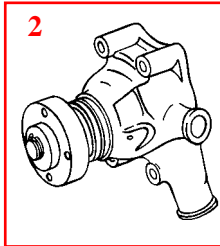
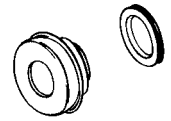

Juego de reparación
Repair kit

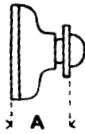
| Tractores Tractors | Fig. Fig. | OEM OEM | Bomba de agua Water pump | Turbina Impeller | Juego de reparación Repair kit |
|--|--------------|--------------------------|---|---|-----------------------------------|
| D.212 ⇄ D.219, D.320 ⇄ D.326, D.430 ⇄ D.440, DED2 | 1 | 718891R97 716410R99 | 25/130-56 (A) | Ø 82mm | 25/131-56 (3052183R93) |
| Mot. Perkins Engine , Cosechadora / Combine 841 | 2 | 789818R91 | 25/130-33 (B) | | |
| 135D, 137 CIMA (France) | 3 | 763613R95 | 25/130-57 (B) | | 25/131-56 (3052183R93) |
| 353, 383, 423, 453, 533 (D.155), 433, 523, 624, 633, 724 (D.179), 644, 733 (D.206), 743, 745, 744 (D.239), 844 (D.246), 844S, 845 (D.268), 856 (DT.239) + XL | 4 | 3132741R93 | 25/130-59 (B) A = 110 mm | Ø 112mm | 25/131-28 (3055285R94) |
| | | 3136217R92 3132738R93 | 25/130-58 (B) A = 110 mm | Ø 98mm | 25/131-27 (1094012R91) |
| 946, 955 (D.310) 956, 1046, 1055, 1056, 1246, 1255 (D.358) 1455 (DT.402) + XL | 5 | 3138936R92 | 25/130-29 (B) A = 100 mm |  | 25/131-28 (3055285R94) |
| | | 3132676R93 | 25/130-30 (B) A=78mm Eje/ Shaft Ø 16mm | | |
| | | 3144661R93 | 25/130-60 (B) A=78mm Eje/ Shaft Ø 24mm | | |
| MAXXUM 5120 (B4.390), 5130 (B6.590), 5140 (BT6.590), 5150 (BTA6.590) | 6 | A77703 J802358 | 25/130-61 (A) | | |
| MAGNUM 7110, 7120, 7130, 7140 CASE 721, 1660, 1680 Mot. CT6.830, CTA6.830 Engine | 7 | A77704 J802479 | 25/130-62 (B) | | |

(A) : Con polea / With pulley
(B) : Sin polea / Less pulley

Nota : Las bombas y los juegos son adaptables a equipos Manitou con motores Case-IH.
Note : Pumps & kits also fit "MANITOU" equipment with CASE-IH engines

Las referencias originales tienen un propósito identificativo.
Nuestras piezas no son originales.

Part numbers are quoted for reference purposes only.
Our parts and accessories are not original.



CORREAS DEL VENTILADOR
FAN BELTS

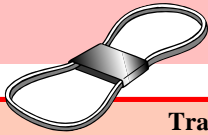

| Tractores Tractors | Alternador Alternator | Bomba de agua Water pump | Dinamo |
|--|--|-----------------------------|--|
| 353, 383, 423, 433, 453, 533, 553, 554, 633, 644, 645, 654, 733, 743, 744, 745, 833, 844, 845, 856 | 71/144-24 (3055715R1) AV.13-1300 | | |
| 523, 533, 624, 724, 824 | | | 71/144-24 (3055715R1) AV.13-1300 |
| 734, 834 | | | 71/144-28 (3136258R1) AV.13-1350 |
| 946, 955, S. XL, 956, 1046, 1055, 1056, 1246, 1255, 1455 | 71/144-27 (3138935R1) AV.13-1425 | | |
| 946, 955, S. XL, 956, 1046, 1055, 1056, 1246, 1255, 1455 Con turbo / With turbo | 71/144-28 (3136258R1) AV.13-1350 | | |

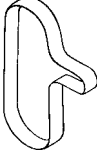
| Fig. | Tractores Tractors | Correa plana Flat belt | OEM | Longitud Length |
|--|---|---------------------------|---------|--------------------|
|  | Maxxum 5120, 5130, MX100, 110, 120, 135 | 71/144-89 | J911558 | 1499mm |
| | Maxxum 5140, 5150, MX100, 110, 120, 135, 150, 170 | 71/144-90 | J911562 | 1460mm |

INSTRUMENTOS (DIVERSOS)
INSTRUMENTS (MISCELLANEOUS)

TAPÓN RADIADOR / RADIATOR CAP

25/151-13
(3134146R1)



433, 533, 633, 644, 645, 724, 743, 744, 745, 856, 844, 845, 856
946, 955, 956, 1046, 1055, 1056, 1255, 1455 (+XL)

TAPÓN DEPOSITO / FUEL TANK CAPS

25/105-10 Ø 74mm
(3221253R1) Todos tractores / All tractors
433 ⇔ 833, 745 ⇔ 1455 (XL+XLA)

25/105-11 Ø 88mm
(3137474R2) 1er serie / 1st serie
644, 744, 844



TERMOSTATOS / THERMOSTATS

25/143-17
(3059676R91)
Según el montaje / According fitment
353 ⇔ 1455 XL



82°

25/143-30
(3055304R92)
523, 624

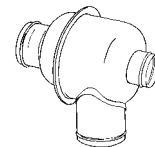

MANOCONTACTO DE PRESIÓN DE ACEITE
OIL PRESSURE SWITCH

25/186-6
(91450C1, 3055238R92)



323, 353, 383, 423, 433, 453, 523, 533, 553, 633, 624, 644, 654, 724, 733, 743XL, 744, 745XL, 824, 844, 844S, 856XL, 946, 955, 956, 1046, 1055, 1056, 1246, 1255, 1455

SENSOR DE TEMPERATURA
TEMPERATURE SENDER

25/180-7
(3057575R91)

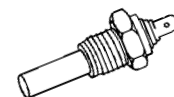

383, 423, 453, 433, 533, 633, 644, 733, 744, 844, 844S, 946, 955, 956, 1046, 1055, 1056

Las referencias originales tienen un propósito identificativo.
Nuestras piezas no son originales.

Part numbers are quoted for reference purposes only.
Our parts and accessories are not original.



MANGUITOS RADIADOR
COOLING HOSES

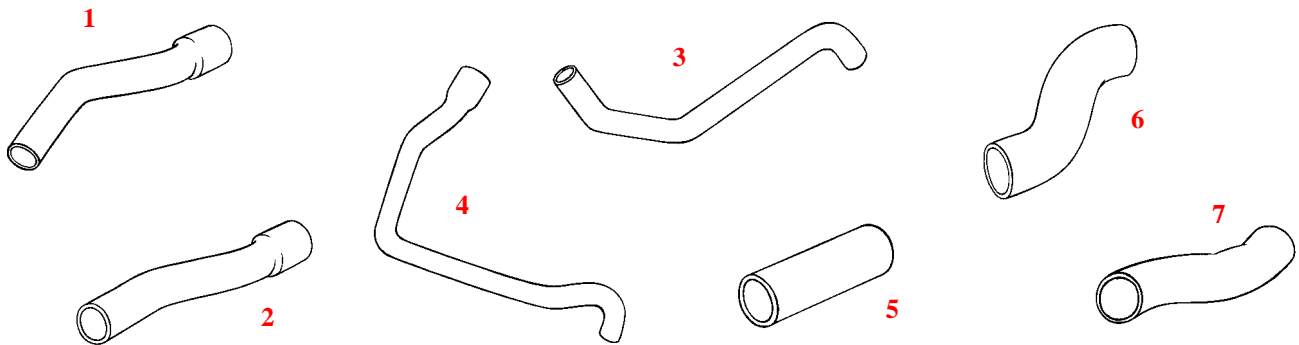

| Tractores Tractors | Fig. Fig. | Superior Top hose | Fig. Fig. | Inferior Bottom hose |
|---|--------------|--------------------------|--------------|--------------------------|
| 353, 383, 423, 453, 523 | | | 2 | 25/153-33 (3134506R1) |
| 433, 533, 633, 733E, V. | 1 | 25/153-32 (3148117R1) | 5 | 25/154-32 (3216754R1) |
| 554, 624, 644, 724, 743, 744, 745, 824, 844, 845, 856 (+ XL) | 2 | 25/153-34 (3134507R1) | 5 | 25/154-34 (3057428R1) |
| 733, 833 | | 25/153-33 (3134506R1) | | 25/154-33 (3399199R1) |
| 946 | | | | 25/154-32 (3216754R1) |
| 955, 956, 1055, 1056 (+ XL) | 3 | 25/153-35 (3220434R1) | 6 | 25/154-35 (3220435R1) |
| 1255, 1455 (+ XL) | | | | |
| 1255, 1455 (+ XL) con airco With air conditioning | 4 | 25/153-91 (3404225R1) | 7 | 25/154-91 (3226798R1) |

MANGUITOS DE BOMBA DE AGUA / BY-PASS HOSES

25/142-6
(3132719R1)



423, 433, 523, 533, 633, 554, 624,
644, 946, 955, 323, D serie

25/142-7
(3132720R1)



733, 744, 844, 844S, 856,
1046, 1055, 956, 1056



COLECTORES DE REFRIGERACIÓN
COOLANT MANIFOLDS

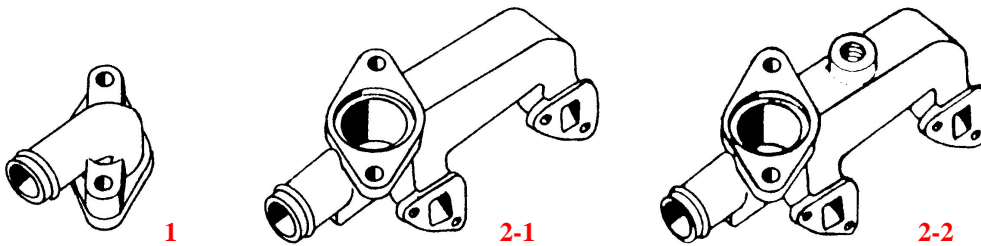

| | 1 | 2 |
|--|----------------------------------|---|
| Tractores <i>Tractors</i> | Carcasa <i>Housing</i> | Colector de refrigeración <i>Coolant manifold</i> |
| 323, 353, 423, 433, 453, 533, 553, 624, 654, 724, 824 | 25/149-3 (3132718R1) 1 | 25/6050-1 (3132717R1) 2-1 |
| 383, 440, 540, 640, 740, 840, 940, 745S, 845S, 1255, 1255XL, 1455, 1455XL | | |
| 433, 533, 633, 644, 733, 743, 743XL, 744, 745XL, 833, 844, 844S, 844XL, 845, 856XL, 933, 945S, 946, 955, 956, 956XL, 955XL, 1046, 1055, 1055XL, 1056, 1056XL, 1246 | | 25/6050-2 (3218330R1, 3218257R1) 2-2 |

FILTROS
FILTERS

| CUBETA CRISTAL GLASS FUEL BOWLS | | | |
|--|--|---|---|
| 25/112-1 (3069610R1) | | Tipo / Type : CAV Base plana/ Flat bottom Altura/ Height 54 mm Ø aguj./ hole Ø : 25,4 mm | 25/112-4 (3144478R1) |
| | | | |
| | | | Tipo / Type : BOSCH Base convexa/ Convex bottom Altura/ Height 48 mm Ø agujero/ hole Ø : 9 mm |
| | | | 25/112-5 (3132197R1) |
| | | | |
| | | | Tipo / Type : BOSCH Base convexa/ Convex bottom Altura/ Height 43 mm Ø agujero/ hole Ø : 17,4 mm |

FILTRO DE CABINA
CAB FILTER

Cabina XL Cab

60/4200-2
(3233584R2)
325x150x43mm

FILTRO DE AGUA
WATER FILTER

544, 554, 644, 744, 624, 654, 724, 743, 743S, 743LX, 745, 745S, 745XL, 745 XL Plus, 824, 826, 844, 844S, 844XL, 845XLA, 845XL Plus, 846, 856XL, 856XLA, 946, 955, 956XL, 1046, 1046A, 1055, 1056XL, 1246, 1255, 1455, 1455XL

60/156-3
(1329039C1, A77544)

Las referencias originales tienen un propósito identificativo.
Nuestras piezas no son originales.

Part numbers are quoted for reference purposes only.
Our parts and accessories are not original.



**FILTROS
FILTERS**

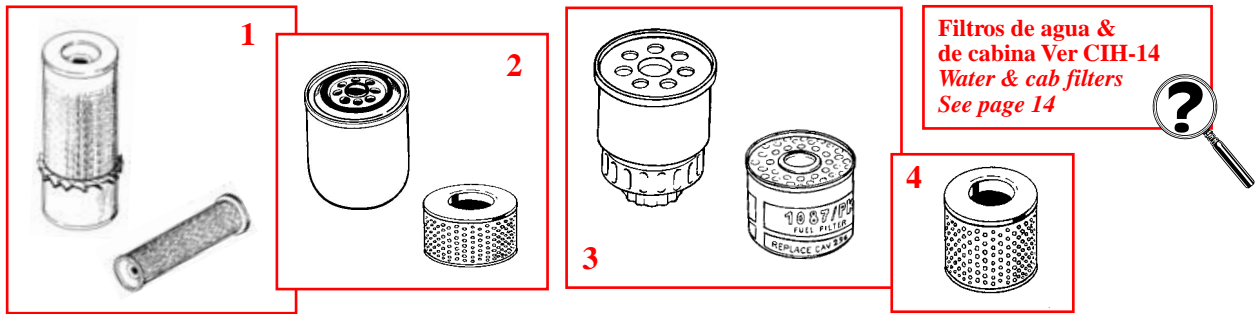

| Tractores Tractors | 1 Aire / Air | | 2 Aceite Oil | 3 Combustible Fuel | 4 Hidráulico Hydraulic |
|--|--|---------------------------------|--------------------------------|---|---|
| | Ext. / Out. | Int. / Inn. | | | |
| F135D, F137D, F240 | | | | 60/111-2 (704640R91) o / or 60/111-3 (1502155C91) (Reempl. CAV 296) | |
| F270D | | | 60/96-14 (795840R91) | 60/111-3 (1502155C91) (Reempl. CAV 296) | |
| D.214, D.215, D.217, D.219, D.320, D.322, D.324, D.326, D.430, D.432, D.436, D.439 | | | | 60/111-64 (712628R91) (Filtro/ Felt) o / or 60/111-32 (3056982R1) | |
| 323, 353, 383, 423, 453, 483, 523, 553 | | | | 60/111-3 (1502155C91) (Reempl. CAV 296) o / or 60/111-16 (3132428R2) | 60/240-46 (3147441R92) (Roscado / Spin-on) |
| 433, 533, 633, 733, 833 | 60/161-18 (3146927R1) Alt./Ht.: 299mm | 60/162-18 (3148080R1) | 60/97-4 (3136458R91) | 60/111-3 x2 (1502155C91) (Reempl. CAV 296) | 60/240-44 (3405722R2) Alt./Ht.: 73mm o / or 60/240-43 (1328276C1) Alt./Ht.: 118mm |

Las referencias originales tienen un propósito identificativo.
Nuestras piezas no son originales.

Part numbers are quoted for reference purposes only.
Our parts and accessories are not original.



"THE RELIABLE SERVICE"



| Tractores Tractors | 1 | | 2 | 3 | 4 |
|---|---|---------------------------------|---------------------------------|--|---|
| | Aire / Air | | Aceite Oil | Combustible Fuel | Hidráulico Hydraulic |
| | Ext. / Out. | Int. / Inn. | | | |
| 544, 554, 644, 744, 844, 844S | 60/161-19 (3146576R1) Alt./Ht.: 332mm | 60/162-19 (3147878R1) | 60/97-11 (3136459R91) | 60/111-3 (1502155C91) (Reempl. CAV 296) | 60/240-44 (3405722R2) Alt./Ht.: 73mm o / or 60/240-43 (1328276C1) Alt./Ht.: 118mm o / or 60/240-46 (3147441R92) (Roscado / Spin-on) |
| 624, 654, 724, 826, 846 | | | | | 60/240-46 (3147441R92) (Roscado/ Spin-on) |
| 743, 743S, 743LX, 745, 745S, 745XL, 745XL Plus | | | | | 60/240-44 (3405722R2) Alt./Ht.: 73mm o / or 60/240-43 (1328276C1) Alt./Ht.: 118mm |
| 824, 844XL | 60/161-19 (3146576R1) Alt./Ht. : 332mm | 60/162-19 (3147878R1) | 60/97-11 (3136459R91) | | 60/240-44 (3405722R2) Alt./Ht.: 73mm o / or 60/240-43 (1328276C1) Alt./Ht.: 118mm o / or 60/111-3 (1502155C91) (Reempl. CAV 296) 60/240-46 (3147441R92) (Roscado/ Spin-on) |
| 845XLA, 845 XL Plus | 60/161-19 (3146576R1) Alt./Ht.: 332mm o / or 60/161-17 (3125342R2) | | | 60/111-16 (3132428R2) (Con purgador With steam trap) o / or | 60/240-43 (1328276C1) Alt./Ht.: 118mm |
| 856XL, 856 XLA | 60/161-35 (3146939R1) Alt./Ht.: 346mm | 60/162-20 (3216100R1) | 60/97-12 (3132737R93) | 60/111-25 (3218793R91) | 60/240-44 (3405722R2) Alt./Ht.: 73mm o / or 60/240-43 (1328276C1) Alt./Ht.: 118mm |
| 946, 955, 1055 | 60/161-19 (3146576R1) Alt./Ht.: 332mm | 60/162-19 (3147878R1) | | | 60/240-44 (3405722R2) Alt./Ht.: 73mm |

Las referencias originales tienen un propósito identificativo.
Nuestras piezas no son originales.

Part numbers are quoted for reference purposes only.
Our parts and accessories are not original.



"THE RELIABLE SERVICE"



| Tractores Tractors | 1 | | 2 | 3 | 4 |
|--|---|---|--|---|---|
| | Aire / Air | | Aceite Oil | Combustible Fuel | Hidráulico Hydraulic |
| | Ext. / Out. | Int. / Inn. | | | |
| 956XL, 1056XL | 60/161-19 (3146576R1) Alt./Ht.: 332mm | 60/162-19 (3147878R1) | | | 60/240-44 (3405722R2) Alt./Ht.: 73mm o / or 60/240-43 (1328276C1) Alt./Ht.: 118mm o / or 60/240-46 (3147441R92) (Roscado/ Spin-on) |
| 1046, 1046A | | | 60/97-12 (3132737R93) | 60/111-3 (1502155C91) (Reempl. CAV 296) o / or 60/111-16 (3132428R2) (Con purgador With steam trap) | |
| 1246 1055 (2do. serie / 2nd serie) | 60/161-35 (3146939R1) Alt./Ht.: 346mm | 60/162-20 (3216100R1) | | o / or 60/111-25 (3218793R91) | |
| 1255, 1455, 1455XL | 60/161-31 (3226416R1) Alt./Ht.: 378mm | 60/162-31 (3219421R1) | | | 60/240-43 (1328276C1) Alt./Ht.: 118mm |
| Maxxum 5120 | 60/161-60 (D56453) Alt./Ht.: 394mm | 60/162-25 (N8153) Alt./Ht.: 360mm | 60/97-53 (J908616) | 60/111-44 (J925274) (Primario / Primary) Rosca/ Thread 13/16" | |
| Maxxum 5130, 5140, 5150, 5230, 5240, 5250 | o / or 60/161-65 (A47032) Alt./Ht.: 370mm | o / or 60/162-65 (A47033) Alt./Ht.: 335mm | 60/97-51 (J908615) | 60/111-56 (J903640) (Secundario / Secondary) Rosca/ Thread 16mm | 60/240-70 (1976934C4) |
| Maxxum MX 100, MX 110, MX120, MX135 | | | | 60/111-16 (3132428R2) (Con purgador With steam trap) | |
| Magnum 7110, 7120, 7130, 7140, 7150 | | | 60/97-47 (A77537) Rosca/ Thread 1 1/2" | 60/111-44 (J925274) (Primario / Primary) Rosca/ Thread 13/16" | |
| Magnum 7210, 7220, 7230, 7240, 7250 | 60/161-79 (A171255) | 60/162-79 (A171256) | 60/97-74 (J919562) Rosca/ Thread 2 1/4" | 60/111-56 (J903640) (Secundario / Secondary) Rosca/ Thread 16mm | 60/641-16 (1971728C1) |
| 3388, 3588, 3788, 5088, 5288, 5488, 6388, 6588, 6788, 7288, 7488 | 60/161-28 (67974C4) | 60/162-28 (67975C1) | | 60/111-49 (A184773) (Roscado/ Spin-on) Rosca/ Thread 1" o / or 60/111-45 (A184774) (Roscado / Spin-on) Rosca/ Thread 7/8" | 60/240-42 (530144R92) |

Las referencias originales tienen un propósito identificativo.
Nuestras piezas no son originales.

Part numbers are quoted for reference purposes only.
Our parts and accessories are not original.



"THE RELIABLE SERVICE"



FILTRO / FILTER

**FILTRO HIDRAULICO
HYDRAULIC FILTER**

60/ 240-35

(3229787R1,
3140498R91,
3217969R1)

(ZF eje delantero)
(ZF axle)

946, 1046,1246,1255,
1255XL, 1455, 1455XL



Ref. n° / Order N° ⇨ Antigua Ref./ Old Ref.

| REF. N° ORDER N° | ANT. REF. OLD REF. |
|---------------------|-----------------------|
| 60/96-1 | 111 |
| 60/96-5 | 110 |
| 60/96-14 | 143 |
| 60/96-18 | 73 |
| 60/97-2 | 599AR/F |
| 60/97-4 | 305/F |
| 60/97-9 | 03116609R92 |
| 60/97-11 | 189 (IH) |
| 60/97-12 | 03132737R93 |
| 60/97-27 | 439 |
| 60/97-47 | 2026 |
| 60/97-51 | 2069 |
| 60/97-53 | 2120 |
| 60/111-1 | 1001 |
| 60/111-2 | 1005 |
| 60/111-3 | 1087/PK |
| 60/111-16 | 1194/F |
| 60/111-25 | 5006/F |

| REF. N° ORDER N° | ANT. REF. OLD REF. |
|---------------------|-----------------------|
| 60/111-32 | 1007 |
| 60/111-44 | 5007 |
| 60/111-45 | 5012 |
| 60/111-49 | 9360 |
| 60/111-56 | 1157/F |
| 60/111-64 | F.1007 |
| 60/156-3 | 25/1329039 |
| 60/161-15 | 0529854R2 |
| 60/161-16 | 03125199R2 |
| 60/161-17 | 03125342R2 |
| 60/161-18 | 2452 |
| 60/161-19 | 2467 |
| 60/161-28 | 067974C4 |
| 60/161-31 | 2402 |
| 60/161-35 | 2427 |
| 60/161-60 | 2465 |
| 60/161-65 | 2935 |
| 60/161-79 | 25/A171255 |

| REF. N° ORDER N° | ANT. REF. OLD REF. |
|---------------------|-----------------------|
| 60/162-16 | 03115/569R2 |
| 60/162-17 | 03125255R1 |
| 60/162-18 | 9667 |
| 60/162-19 | 9665 |
| 60/162-20 | 9649 |
| 60/162-25 | 2466 |
| 60/162-28 | 067975C1 |
| 60/162-31 | 9650 |
| 60/162-65 | 2939 |
| 60/162-79 | 25/A171256 |
| 60/240-42 | 0530144R92 |
| 60/240-43 | 25/1328276 |
| 60/240-44 | 25/3405722 |
| 60/240-46 | R.3147441 |
| 60/240-70 | 51759 |
| 60/574-15 | D960750 |
| 60/641-16 | 25/1971728 |

**SILENCIOSOS
SILENCERS**

| Fig. | 1 | 2 |
|-------------------------|--|---|
| Tractores Tractors | Silencioso Silencer | Tubo Pipe |
| Maxxum 5120 | 25/165-102 (A184460) 1-1 | 25/166-12 (A189049, A189943) |
| Maxxum 5130, 5140, 5150 | 25/165-103 (A184475) 1-2 | |



Las referencias originales tienen un propósito identificativo.
Nuestras piezas no son originales.

Part numbers are quoted for reference purposes only.
Our parts and accessories are not original.



**SILENCIOSOS (VERTICAL)
MUFFLERS (VERTICAL)**

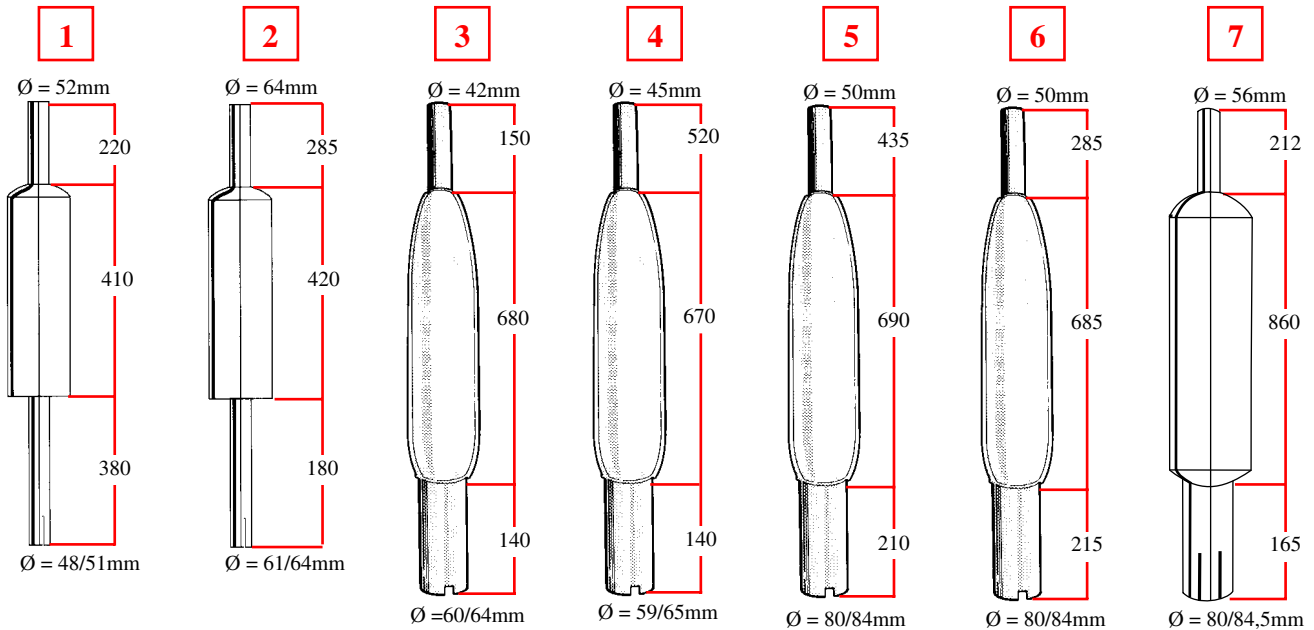

| Tractores Tractors | Fig. Fig. | Silencioso Mufflers | Tapa Weathercap | Abrazadera Exhaust clamp |
|--|--------------|---------------------------|-------------------------|-----------------------------|
| Modelos antiguos (423, ...) Early tractors (423, ...) | 1 | 25/165-90 (704616R96) | 70/2930-57 (5870/22) | 70/2935-54 (MC5856) |
| 383, 453, 454, 474, 523, 624, 724, 824 | 2 | 25/165-91 (3245279R91) | 70/2930-64 (5870/23) | 70/2935-64 (MC5865) |
| 433, 533, 553, 633, 733, 833 | 3 | 25/165-33 (3216683R5) | 70/2930-45 (5870/10) | |
| 644, 744, 844, 844S, 645, 745, 845 | 4 | 25/165-34 (3145624R9) | 70/2930-51 (5870/21) | |
| 955, 1055, 956, 1056 (+ XL) | 5 | 25/165-37 (3220369R96) | 70/2930-57 (5870/22) | |
| 856 (+ XL) | 6 | 25/165-35 (3404966R4) | | |
| 1255, 1455 (+XL) | 7 | 25/165-92 (3226762R4) | 70/2930-64 (5870/23) | |

**COLECTOR DE ESCAPE
EXHAUST MANIFOLD**

25/65-10
(3058003R1)

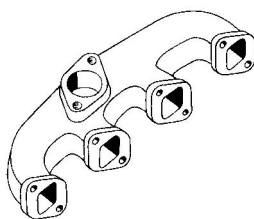

624, 644, 744, 844, 844S

**SOPORTES DEL ESCAPE
EXHAUST ELBOW**

25/164-17
(3059921R1)

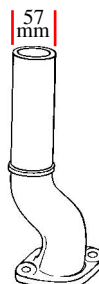

553, 654, 724, 824

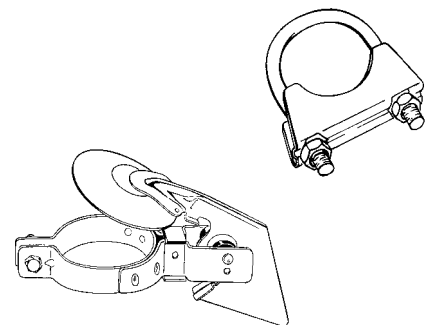

Las referencias originales tienen un propósito identificativo.
Nuestras piezas no son originales.

Part numbers are quoted for reference purposes only.
Our parts and accessories are not original.



**LUCES
LIGHTING**

FAROS DELANTEROS / FRONT LIGHT LENSES

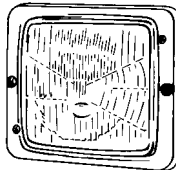
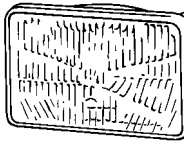
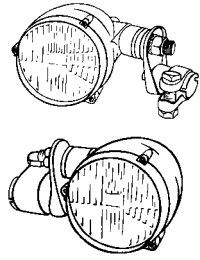
| | | | | |
|-------------|------------|--|---|---|
| 25/181-19 | 3404170R94 | Faro (asimétrico) Complete lens (asymmetrical) Izq. o drcha. / LH or RH |  | Series/ series 33, 44, 45 & 55 |
| 63/1955-410 | 10/12620 | <u>Bombilla / Bulb</u> | | |
| 25/181-22 | 1333291C1 | Faro / Complete lens Izq. o drcha (163 x 104) LH or RH (163 x 104) |  | (Nueva gama Case-IH) (New range Case-IH) |
| 63/1955-472 | 10/12342 | <u>Bombilla / Bulb</u> | | |
| 25/189-202K | ET.1400K2 | Pareja de faros halógenos 3 funciones, Ø 144mm Con bridas de fijación para tubos Ø 24 mm 2 halogens, Ø 144mm 3 functions lens set with fitting clamps for tube Ø 24mm |  | Gama alemana antigua Old german range |
| 63/1955-472 | 10/12342 | <u>Bombilla / Bulb</u> | | |

LUCES DELANTERAS DE POSICIÓN E INTERMITENTES / SIDE LIGHTS AND INDICATORS

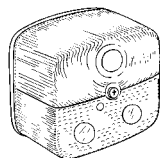
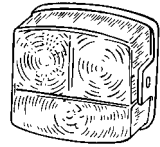
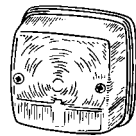
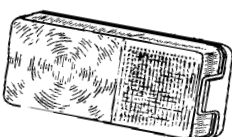
| | | | | |
|--|--|--|--|---|
| 25/1918-7 25/1918-8 25/1919-7 25/1919-8 63/1955-245 63/1955-382 | 82364C91 82363C91 90308C1 90309C1 10/12814 10/12498 | Blanca y naranja/ White and orange Luz izq./ Light (LH) Luz drcha./ Light (RH) <u>Tulipa izq./ Glass (LH)</u> <u>Tulipa drcha./ Glass (RH)</u> <u>Bombilla / Bulb</u> <u>Bombilla / Bulb</u> |  | Series/ series 33 & 44 Montaje / Fitting "JOKON" |
| 25/1918-9 25/1918-10 25/1919-9 25/1919-10 63/1955-245 63/1955-382 | 3226119R1 3226120R1 3059187R1 3058242R1 10/12814 10/12498 | Blanca y naranja/ White and orange Luz izq./ Light (LH) Luz drcha./ Light (RH) <u>Tulipa izq./ Glass (LH)</u> <u>Tulipa drcha./ Glass (RH)</u> <u>Bombilla / Bulb</u> <u>Bombilla / Bulb</u> |  | Series/ series 33, 44 & 55 Montaje / Fitting "HELLA" |
| 25/1918-3 25/1919-3 63/1955-239 63/1955-382 | 3121089R91 3148501R1 10/12844 10/12498 | Luz / Light <u>Tulipa / Glass</u> <u>Bombilla / Bulb</u> <u>Bombilla / Bulb</u> |  | Series/ series 33, 43, 44, 45 & 55 |
| 25/1918-11 25/1919-11 63/1955-207 63/1955-382 | 3221211R91 3224290R1 10/12821 10/12498 | Blanca y naranja/ White and orange Luz / Light <u>Tulipa / Glass</u> <u>Bombilla / Bulb</u> <u>Bombilla / Bulb</u> |  | 743, 745, 844, 856, 956, 1056, 1255, 1455 XL serie / XL serie |

Otras clases de luces se pueden encontrar en la sección de luces en la .1.parte del catálogo
Other suitable lights can be found in the lighting section (part 1 of the catalogue).





Las referencias originales tienen un propósito identificativo.
Nuestras piezas no son originales.

Part numbers are quoted for reference purposes only.
Our parts and accessories are not original.

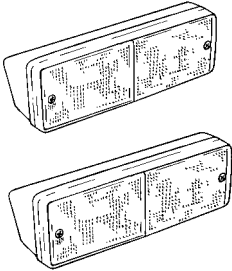

**LUCES
LIGHTING**

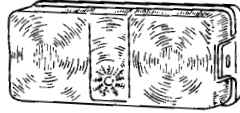
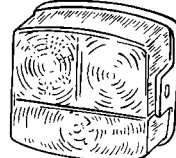
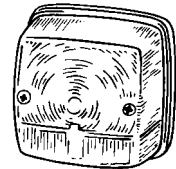
LUCES TRASERAS / REAR LIGHTS

| | | | | |
|--|--|---|--|---|
| 25/1912-24 25/1912-25 25/1912-26 25/1913-20 63/1955-380 63/1955-382 | R843K ET047/022 ET047/025 ET047/026 10/12500 10/12498 | Pareja de luces traseras/ <i>Rear lights</i> 180 x 58mm Luz trazera drcha./ <i>RH rear light</i> Luz trazera izq./ <i>LH rear light</i> <u>Tulipa / Glass</u> <u>Bombilla / Bulb</u> <u>Bombilla / Bulb</u> |  | 323, 353, 423, 523, 624, 724 (Reempl. / <i>Rpl.</i> 3057566R91, 3057567R91) |
| 25/1913-21 | 3058245R1 | Montaje / <i>Fitting</i> "HELLA" <u>Tulipa izq y drcha. / Glass (LH or RH) :</u> (↔ <i>stock end</i>) (Reempl. para / <i>replaced by</i> 25/1912-24) |  | 323, 353, 423, 523, 624, 724 |
| 25/1912-27 25/1912-28 25/1913-27 25/1913-28 63/1955-245 63/1955-382 | 3145942R91 3145943R91 3145945R1 3145946R1 10/12814 10/12498 | Luz trazera izq./ <i>LH rear light</i> Luz trazera drcha./ <i>RH rear light</i> <u>Tulipa izq./ Glass (LH)</u> <u>Tulipa drcha./ Glass (RH)</u> <u>Bombilla / Bulb : 1x</u> <u>Bombilla / Bulb : 2x</u> |  | Series 43, 44, 45, 55 & 56 XL series |
| 25/1912-29 25/1912-30 25/1913-29 25/1913-30 63/1955-245 63/1955-382 | 3223263R91 3223264R91 3226117R1 3226118R1 10/12814 10/12498 | Luz trazera izq./ <i>LH rear light</i> Luz trazera drcha./ <i>RH rear light</i> <u>Tulipa izq./ Glass (LH)</u> <u>Tulipa drcha./ Glass (RH)</u> <u>Bombilla / Bulb : 1x</u> <u>Bombilla / Bulb : 2x</u> |  | 433, 533, 633, 733, 833 |
| 25/1912-31 25/1913-31 63/1955-245 63/1955-382 | 3148492R91 3148499R1 10/12814 10/12498 | Luz trazera / <i>rear light</i> <u>Tulipa / Glass</u> <u>Bombilla / Bulb : 1x</u> <u>Bombilla / Bulb : 2x</u> |  | Series 33, 43, 44, 45, 55, & 56 XL series |
| 25/1912-32 25/1912-33 25/1913-32 25/1913-33 63/1955-239 63/1955-382 | 3221209R92 3221210R92 3224286R1 3224287R1 10/12844 10/12498 | Luz trazera izq./ <i>LH rear light</i> Luz trazera drcha./ <i>RH rear light</i> <u>Tulipa izq./ Glass (LH)</u> <u>Tulipa drcha./ Glass (RH)</u> <u>Bombilla / Bulb : 2x</u> <u>Bombilla / Bulb : 2x</u> |  | 743, 745, 856, 955, 956, 1055, 1246, 1255, 1455 Series "45", "55" & "56" XL series |

LUZ DE MATRÍCULA / LIGHTNING PLATE

| | | | | |
|-----------|------------|---|--|--|
| 63/1920-6 | 3231505R91 | Eclaire-plaque <i>Luz de matrícula</i> |  | 238, 248, 258, 268, 288, 395, 485XL, 495, 495XL, 585XL, 595, 685XL, 695, 695XL, 785XL, 795, 795XL, 885XL, 895, 895XL, 959XL, 995XL, 3210, 3220, 3230, 4210, 4220, 4230, 4240 |
|-----------|------------|---|--|--|

Las referencias originales tienen un propósito identificativo.
Nuestras piezas no son originales.

Part numbers are quoted for reference purposes only.
Our parts and accessories are not original.



FAROS DE TRABAJO
WORK LIGHTS

63/1931-3
(ET5171)

Faro de trabajo rectangular
Caja faro (anti-choque)
Gran ángulo de iluminación
Luz halógena, sin maneta

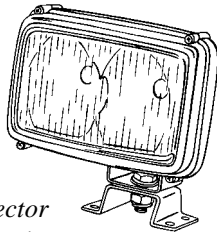

*Work lamp with free-form reflector
Extremely wide-angled illumination
Halogen H3, Less handle*

Bombillas/ Bulbs :

63/1955-453 (10/12336) : 12V./55W
63/1955-460 (10/13336) : 24V./70W

63/1931-5
(10/W.394)

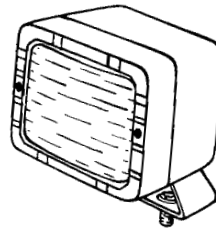

Faro ajustable 360 grados
Luz halógena H3, 112 x 126mm
(Tulipa : 82 x 82mm)

*Adjustable lamp 360°
Halogen H3, 112 x 126mm
(glass : 82 x 82mm)*

Bombillas/ Bulbs :

63/1955-453 (10/12336) : 12V./55W
63/1955-460 (10/13336) : 24V./70W

63/1934-5 - Fijación 63/1931-5
(ET.131) *Bracket for 63/1931-5*

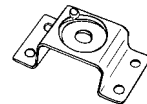

63/1931-4
(ET1253/F)

Luz halógena H3
Con interruptor

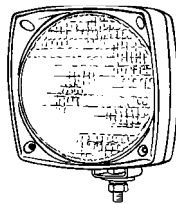

*Halogen H3
With switch*

Bombillas/ Bulbs :

63/1955-453 (10/12336) : 12V./55W
63/1955-460 (10/13336) : 24V./70W

63/1931-9
(ET421/H3)

140 x 90mm
Luz halógena H3
Halogen H3

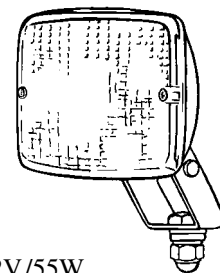

Bombillas/ Bulbs :

63/1955-453 (10/12336) : 12V./55W
63/1955-460 (10/13336) : 24V./70W

63/1918-16
(ET420)

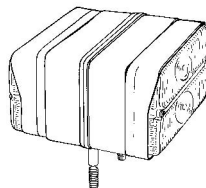

Luz doble para tractores fruteros
Twin mudguard light (For orchard tractors)

Bombillas/ Bulbs : **63/1955-382** (x2) : 12V./21W
(10/12498)
63/1955-207 : 12V./5W
(10/12821)
63/1955-380 : 12V./21W-5W
(10/12500)

63/1931-2

Montaje "RAYDYOT" Fitting
Serie XL serie

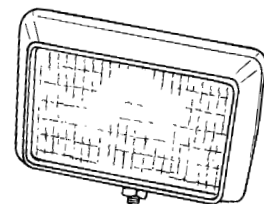

Bombillas/ Bulbs : **63/1955-453** : 12V./55W
(10/12336)
63/1955-460 : 24V./70W
(10/13336)

Otras clases de luces se pueden encontrar en la sección de luces en la .1.parte del catálogo
Other suitable lights can be found in the lighting section (part 1 of the catalogue).



**INTERRUPTORES VARIOS
SWITCHES (MISCELLANEOUS)**

INTERRUPTORES / SWITCHES

**Arranque
Start**

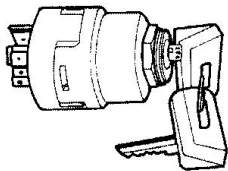

25/950-16 10 terminales / 10 terminals
(1532371C1) 743XL, 745XL, 844XL,
845XL, 856XL

25/950-17 7 terminales / 7 terminals
(1532372C1, 955, 956XL, 1055, 1056XL,
3221154R91) 1255XL, 1455XL

**Luz
Lighting**

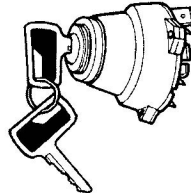

25/950-18 6 terminales
(3136852R1) 6 terminals

European tractors

**Arranque - Calentador
Heating - start**

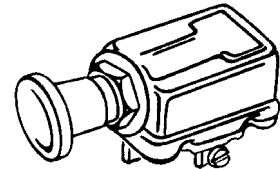

25/950-11 4 terminales
(3057998R91) 4 terminals

INTERRUPTORES COMBINADOS / COMBINED SWITCHES

25/958-1
(3057633R91)

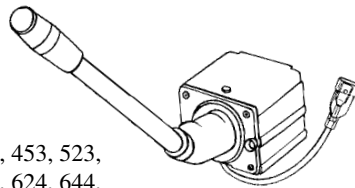

323, 353, 383, 423, 433, 453, 523,
533, 633, 733, 833, 554, 624, 644,
724, 744, 844, 745, 845, 846, 1046, 1246

25/958-2
(3399522R2)

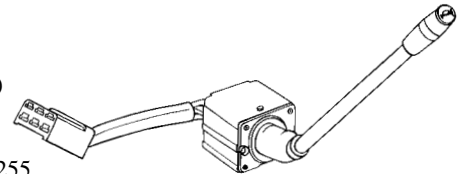

955, 1055, 1255,
1455, 743XL, 745XL,
844XL, 856XL, 956XL, 1056XL

CONECTORES ELÉCTRICOS / ELECTRICAL PLUGS AND SOCKETS

25/1971-4
(1964989C1)



Toma de tres puntos
Socket 3 poles

25/1970-4
(1964583C1)

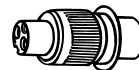

Conexión del tres puntos
Plug 3 poles

25/1971-3
(1533880C1)

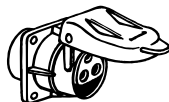

Toma de tres puntos
Socket 3 poles

25/1970-3
(1533899C1)

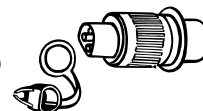

Conexión del tres puntos
Plug 3 poles

Las referencias originales tienen un propósito identificativo.
Nuestras piezas no son originales.

Part numbers are quoted for reference purposes only.
Our parts and accessories are not original.



INSTRUMENTOS DIVERSOS
MISCELLANEOUS ITEMS

UNIDAD DE INTERMITENCIA BOSCH
FLASHER UNIT BOSCH



25/961-3
(3131226R91)

12 V (2+1+1), 21 W

Tipo redondo con silemblock goma y
5 terminales / Round type, 5 pins

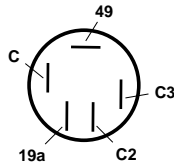

UNIDAD DE INTERMITENCIA COBO
FLASHER UNIT COBO

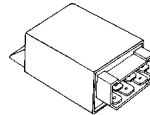

25/961-2
(3142068R5)

12 V (2+1+1), 21 W

Electronic
6 terminales / 6 pins

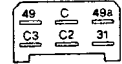

LUZ DE MATRÍCULA
NUMBER PLATE LIGHT

25/1920-2
(3053400R92)

Serie / serie 33

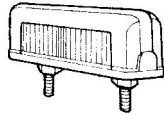

CABLE DE PARO
STOP CABLE

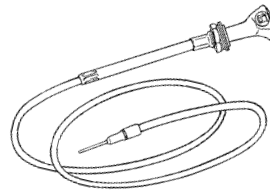

25/107-2
(R9331K)

Lg. 1700mm

CABLES DE CUENTAHORAS
DRIVE CABLES

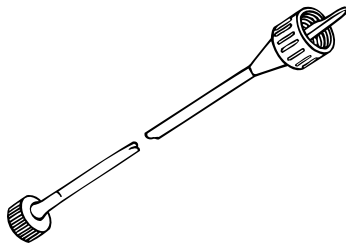

25/177-24 523, 553, 554, 644, 645, 743, 744, 745, ...
(3058286R93, Lg. = 1500mm
3131889R91)

25/177-25 624, 654, 724, 824, 844, 845
(3058287R94) Lg. = 1600mm

25/177-26 955, 956, 1046, 1055, 1056, 1246, 1255, 1455
(3229694R2) Lg. = 2500mm

FUSIBLES PLANOS
MICRO-FUSES

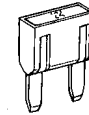

Por 50 piezas / Available by 50 pieces

| | | |
|--------------------|------|-------------------------|
| 63/1787-5 | 5A | Crema / Light brown |
| 63/1787-7.5 | 7,5A | Marrón / Chestnut brown |
| 63/1787-10 | 10A | Rojo / Red |
| 63/1787-15 | 15A | Azul / Blue |
| 63/1787-20 | 20A | Amarillo/ Yellow |
| 63/1787-25 | 25A | Transparente |
| 63/1787-30 | 30A | Verde/ Green |

Para más información ver la gama completa en la sección 1 del catálogo.
For further details, see the complete range in part 1 of the catalogue .



EMBRAGUES Y DISCOS DE EMBRAGUE
CLUTCH ASSEMBLIES AND PLATES

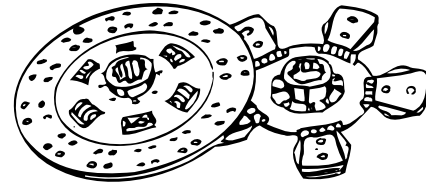
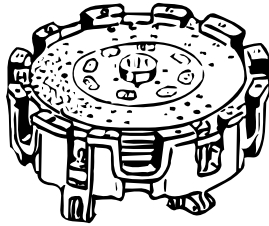

| TRACTORES TRACTORS | EMBRAGUE CLUTCH | | DISCO PLATE | | RODAMIENTO EMPUJE RELEASE BEARING |
|---|-----------------------------------|---|----------------|---|---|
| | Ø | REF. N° ORDER N° | Ø | REF. N° ORDER N° | |
| 323 | 225 | (1881 089 002) 25/200-111 (787514R91) (787513R91) | 225 (A) | (1861 266 001) 25/221-111 13Z 21,7x25 (787515R91) | 25/231-15 (3136858R11) Aro de carbono Carbon ring |
| 323, 353, 383, 423, 433, 440, 453, 533/A, 540 | 228/250 6 patillas 6 levers | 225.0044.11 25/200-53 (3134875R91, 3216398R94) | 228 (A) | (323 0042 16) 25/212-12 (LK) 25Z 41x45 | 25/231-46 (80x137x42) (25/786533) |
| | | | 228 (A) | 25/212-12E (LK) (VZ) 25Z 41x45 (3134885R92) | 25/231-12 65x102x18 (786532R91) |
| | | | 250 (A) | (325 0100 16) 25/221-53 (LN) 13Z 22x25 Grosor / Thick. 10.3mm | 25/231-14 75x115x20 (3142880R91) |
| | | | 250 (A) | (325001816) 25/221-178 (LN) 13Z 22x25 Grosor / Thick. 8.9mm | (410 0026 00) 25/230-9 (RV) (3218393R91) |
| | | | 250 (A) | 25/221-53E (LN) (VZ) 13Z 22x25 (3225978R91) | |
| 353, 383 423 | 250 | (1881 009 201) 25/200-112 (3139819R91) | 250 (B) | (1861 259 101) 25/221-112 13Z 21,7x25 | 25/231-15 Aro de carbono Carbon ring (3136858R11) |
| | | | 250 (A) | 25/221-112E (VZ) 13Z 21x25 Fijo / Fixed (3058676R92) | |
| | | | 250 (A) | 25/221-113 13Z 21x25 Muelles / Springs (3148964R91) | |
| 430, 436, 439, 440 | 250 | (1881 009 201) 25/200-112 (3139819R91) (3139821R91) | 250 (A) | (1862 001 101) 25/221-123 10Z 26x32 (3054380R91) | 25/231-15 (3136858R11) Aro de carbono Carbon ring |
| 523 (→ 20469) 624 (→ 20469) 724 (→ 20469) | 280 | (1880 096 206) 25/200-47 (3057150R92) | 280 (A) | (1861 260 101) 25/221-114 10Z 26x32 | 25/231-15 (3136858R11) Aro de carbono Carbon ring |
| | | | 280 (A) | 25/221-114E (VZ) 10Z 26x32 (3057151R92) | |

Las referencias originales tienen un propósito identificativo.
Nuestras piezas no son originales.

Part numbers are quoted for reference purposes only.
Our parts and accessories are not original.



"THE RELIABLE SERVICE"



| TRACTORES TRACTORS | EMBRAGUE CLUTCH | | DISCO PLATE | | RODAMIENTO EMPUJE RELEASE BEARING |
|--|-----------------------------------|---|--|---|--|
| | Ø | REF. N° ORDER N° | Ø | REF. N° ORDER N° | |
| 523 (20470 →) 624 (20470 →) 724 (20470 →) | 280 | (1880 096 206) 25/200-47 (3057150R92) | 280 (A) 280 (A) | (1861 331 106) 25/221-47 10Z 23x29 25/221-47E (VZ) 10Z 23x29 (3059214R94) | 25/231-15 Aro de carbono Carbon ring (3136858R11) |
| 523, 553, 554, 564, 624, 644, 654, 724, 734, 743 XL, 743 XLA, 744, 745 XL, 745 XLA, 754, 824, 834, 844 S, 844 XL, 844 XLA, 845, 845 XL | 280/300 6 patillas 6 levers | (230 0011 14) 25/200-56 (1964056C2) | 280 (B) 280 (A) 295 (B) 295 (B) 295 (A) 280 (A) 280 (B) | (328 0023 12) 25/212-32 (LK)(D) 22Z 41x45 (1964088C1) 25/212-13 (LK) (VZ) 22Z 41x45 (3058404R93) ----- (330 0015 12) 25/221-58 (LN)(E) 10Z 23x29 25/221-58E (LN)(F) (VZ) 10Z 23x29 (3225094R3) 25/221-57 (LN) (VZ) 10Z 23x29 (3225950R1) 25/221-115 (LN) (VZ) 10Z 23x29 (3058405R93) 25/221-56 (LN) (VZ) 10Z 23x29 (3137677R3) | 25/231-14 75x115x20 (3142880R91) 25/231-13 65x102x27 (3147877R91) (410 0026 00) 25/230-9 (RV) (3218393R91) |
| Juego completo de prensa y disco <i>Complete clutch assembly with plate</i> 25/200-56K - (230001114 + 330001512) (135506A2) | | | | | |
| 533, 633, 640, 733, 733A, 740 | 228/290 6 patillas 6 levers | (229 0001 12) 25/200-55 (3225545R92, 1964054C1) | 228 (A) 228 (A) 290 (A) 290 (A) | (323 0042 16) 25/212-12 (LK) 25Z 41x45 25/212-12E (LK) 25Z 41x45 (3134885R92) ----- (329 0001 16) 25/221-55 (LN) 13Z 21,5x25 25/221-55E (LN) (VZ) 13Z 21,5x25 (3224546R92) | 25/231-14 75x115x20 (3142880R91) 25/231-12 65x102x18 (786532R91) (410 0026 00) 25/230-9 (RV) (3218393R91) |
| 633, 640, 733, 733A, 740, 833, 840, 940 | 228/290 6 patillas 6 levers | (229 0001 11) 25/200-116 (3404116R91, 1964055C1) (Reforzado Heavy duty) | 228 (B) 290 (A) 290 (A) 290 (B) | (323 0042 11) 25/212-33 (LK)(D) 25Z 41x45 (3404117R91) ----- (329 0001 16) 25/221-55 (LN) 13Z 21,5x25 25/221-55E (LN) (VZ) 13Z 21,5x25 (3224546R92) (329 0001 11) 25/221-116 (LN)(E) 13Z 21,5x25 (1964154C1) | 25/231-14 75x115x20 (3142880R91) 25/231-12 65x102x18 (786532R91) (410 0026 00) 25/230-9 (RV) (3218393R91) |

Las referencias originales tienen un propósito identificativo.
Nuestras piezas no son originales.

Part numbers are quoted for reference purposes only.
Our parts and accessories are not original.



| TRACTORES TRACTORS | EMBRAGUE CLUTCH | | DISCO PLATE | | RODAMIENTO EMPUJE RELEASE BEARING |
|---|-----------------------------------|---|---|---|---|
| | Ø | REF. N° ORDER N° | Ø | REF. N° ORDER N° | |
| 844, S 845, S | 280 | (1880 083 111) 25/200-49 (3145303R1) | 280 (B) 280 (A) | (1861 450 001) 25/221-48 (D) 10Z 23x29 (3142128R91) 25/221-117 (VZ) 10Z 23x29 (3142099R91) | |
| 856 XL, 856 XLA, 955 XL, 956XL, 956 XLA, 1050 XL, 1056 XL, 1056 XLA | 310/310 6 patillas 6 levers | (231 0023 13) 25/200-118 (1964221C1) | 310 (A) ----- 310 (B) 310 (B) | (331 0073 17) 25/212-35 (LK) 22Z 41x45 (1964222C2) ----- (331 0075 11) 25/221-60 (LN)(G) 10Z 23x29 25/221-60E (LN)(VZ)(E) 10Z 23x29 (3224423R93) | 25/231-14 75x115x20 (3142880R91) 25/231-13 65x102x27 (3147877R91) (410 0017 10) 25/230-11 (RV) (3228525R91) |
| 856 XL, 856 XLA, 955 XL, 956 XL, 956 XLA, 1055 XL, 1056 XL, 1056 XLA | 310/310 6 patillas 6 levers | (231 0023 14) 25/200-60 (1964057C1, 3220807R94, 3234724R93) (Reforzado Heavy duty) | 310 (B) ----- 310 (B) 310 (B) | (331 0073 11) 25/212-36 (LK)(E) 22Z 41x45 (1964089C1) ----- (331 0075 11) 25/221-60 (LN)(G) 10Z 23x29 25/221-60E (LN)(VZ)(E) 10Z 23x29 (3224423R93) | 25/231-14 75x115x20 (3142880R91) 25/231-13 65x102x27 (3147877R91) (410 0017 10) 25/230-11 (RV) (3228525R91) |
| <p>Juego completo de prensa y disco Complete clutch assembly with plate</p> <p>25/200-202K - (231002314 + 331007511)</p> | | | | | |
| 946, 1046 | 280/280 6 patillas 6 levers | (228 0038 10) 25/200-59 (3141565R93) | 280 (B) 280 (B) 280 (A) 295 | (328 0107 10) 25/221-59 (LG)(F) 23Z 44x48 25/221-59E (LG) (VZ) 23Z 44x48 (3141567R93) ----- (328 0153 16) 25/212-14 (LM) 16Z 27x30 (3141177R91) 25/212-34 (LM) 16Z 27x30 (3141177R91) (Solo prensa Only clutch SACHS 280/295) | 25/231-14 75x115x20 (3142880R91) 25/231-13 65x102x27 (3147877R91) (410 0017 10) 25/230-11 (RV) (3228525R91) |
| 1246 | 310/310 6 patillas 6 levers | (231 0003 10) 25/200-119 (3146449R97) | 310 (B) ----- 310 (B) | (331 0011 10) 25/221-119 (LG)(F) 23Z 44x48 (3147053R1) ----- (331 0012 11) 25/212-37 (LM)(F) 16Z 27X30 (3147057R91) | 25/231-14 75x115x20 (3142880R91) 25/231-13 65x102x27 (3147877R91) (410 0017 10) 25/230-11 (RV) (3228525R91) |

Las referencias originales tienen un propósito identificativo.
Nuestras piezas no son originales.

Part numbers are quoted for reference purposes only.
Our parts and accessories are not original.



"THE RELIABLE SERVICE"



| TRACTORES TRACTORS | EMBRAGUE CLUTCH | | DISCO PLATE | | RODAMIENTO EMPUJE RELEASE BEARING |
|--|---|---|---------------------------------------|---|---|
| | Ø | REF. N° ORDER N° | Ø | REF. N° ORDER N° | |
| 1255 XL, 1255 XLA 1455 XL, 1455 XLA | 350/350 6 patillas 6 levers | (235 0003 10) 25/200-120 (1964058C2, 1964060C2, 3226551R98, 3220985R98) | 350 (B) ----- 350 (B) | (335 0080 10) 25/221-120 (LG)(H) 23Z 44x48 (3230720R4) ----- (335 0079 11) 25/212-38 (LM)(H) 16Z 27x30 (1964090C1) | 25/231-14 75x115x20 (3142880R91) 25/231-13 65x102x27 (3147877R91) (410 0017 10) 25/230-11 (RV) (3228525R91) |
| 1255 Hydro-Power 1455 Hydro-Power | 350/350 6 patillas 6 levers | (235 0004 10) 25/200-121 (1964059C1, 1964061C1, 3226552R98, 3230986R98) | 350 (B) ----- 350 (B) | (335 0081 10) 25/221-121 (LG)(F) 23Z 44x48 (3230726R3) ----- (335 0079 11) 25/212-38 (LM)(H) 16Z 27x30 (1964090C1) | 25/231-14 75x115x20 (3142880R91) 25/231-13 65x102x27 (3147877R91) (410 0017 10) 25/230-11 (RV) (3228525R91) |
| 2120, 2130, 2140, 2150 | 280/280 6 patillas 6 levers | (228 0128 10) 25/200-308 (1984811C1) | 280 (A) ----- 280 (A) | (328 0337 10) 25/221-184 (LG) 12Z 30x40 (1984812C1) ----- (328 0338 10) 25/212-39 (LM) 13Z 18,7x22,2 | (500 0459 00) 25/231-142 (1966557C1) (Pequeño Ø / Small Ø) (500 0673 00) 25/231-143 (1966618C1) (Grande Ø / Large Ø) 65x100 |
| | | | 280 (B) ----- 280 (A) | (328 0337 11) 25/221-185 (E) (LG) 12Z 30x40 ----- (328 0338 10) 25/212-39 (LM) 13Z 18,7x22,2 | |
| 2275 | 280 (Con aro de empuje With split ring) | (128 0068 10) 25/200-310 | 280 (B) | (328 0238 10) 25/221-186 (E) (LN) 10Z 23x29 (AAU2906) | (500 0544 10) 25/231-144 |
| CS42, 48, 55, 58, 60 | 280/300 6 patillas 6 levers | (230 0028 10) 25/200-305 (1320000200021) | 280 (B) ----- 290 (A) | (328 0336 10) 25/212-162 (D) (LK) 24Z 44x49 (132000020005) ----- (329 0007 10) 25/221-179 (LN) 15Z 25x28 (132000200041) | |
| CS64, 68, 70, 75 | | | 290 (B) | (329 006 10) 25/221-180 (E) (LN) 17Z 28x32 (1320000200031) | |

Las referencias originales tienen un propósito identificativo.
Nuestras piezas no son originales.

Part numbers are quoted for reference purposes only.
Our parts and accessories are not original.



"THE RELIABLE SERVICE"



| TRACTORES TRACTORS | EMBRAGUE CLUTCH | | DISCO PLATE | | RODAMIENTO EMPUJE RELEASE BEARING |
|---------------------------|---|---|---------------------------------------|---|--|
| | Ø | REF.CDE ORDER N° | Ø | REF.CDE ORDER N° | |
| CS78, 86, 94 | 310/330 6 patillas 6 levers | (233 0034 10) 25/200-306 (1401001600041) | 310 (B) ----- 327 (B) | (331 0228 10) 25/212-163 (E) (LK) 24Z 45x50 (1401001600006) ----- (333 0136 10) 25/221-181 (E) (LN) 17Z 28x32 (1401001600005) | |
| CX50, 60, 70, 80, 90, 100 | 310 (Disco tdf fijo sobre diafr. Fixed PTO on diaph.) | (131 0254 10) 25/200-307 (223807A1) | 305 (B) ----- 310 (B) | (331 0234 10) 25/221-182 (E) (LN) 10Z 23x29 (332123A1) ----- (331 0235 10) 25/221-183 (G) (LN) 10Z 23x29 (330732A1) | |

COSECHADORAS / COMBINES

| | | | | | |
|--|-----|---|------------|--|--|
| 321, 431, 531 (→ 1150) E 841, F 841, F863 | 250 | (125 0045 30) 25/200-122 (544829R91) | 250 (B) | (325 0113 30) 25/221-122 (F) 10Z 26,4x30,9 (547433R91, 785723R91) | |
| 321, 431, 531, (1151 →) 871, 891 | 250 | (125 0044 30) 25/200-123 (60723C1) | 250 (B) | (325 0113 30) 25/221-122 (F) 10Z 26,4x30,9 (547433R91, 785723R91) | |

- (Z) Dientes
 (A) Revestimiento orgánico sin amiento
 (B) Revestimiento cerametalico
 (D) Con 4 palas
 (E) Con 5 palas
 (F) Con 6 palas
 (G) Con 7 palas
 (H) Con 8 palas
 (LG) Disco principal, transmision lateral montada
 (LK) Disco TdF, transmision lateral montada
 (LM) Disco TdF, lado motor libre
 (LN) Disco principal, lado motor libre
 (RV) Cojinete piloto
 (VZ) Versión económica

- (Z) *Teeth*
 (A) *Asbestos free organic lining*
 (B) *Cerametallic lining*
 (D) *4 pairs of pads*
 (E) *5 pairs of pads*
 (F) *6 pairs of pads*
 (G) *7 pairs of pads*
 (H) *8 pairs of pads*
 (LG) *Main disc, transmission side, mounted*
 (LK) *PTO disc, transmission side, inside*
 (LM) *PTO disc, engine side, loose*
 (LN) *Main disc, engine side, outside*
 (RV) *Pilot bearing*
 (VZ) *Economic version*

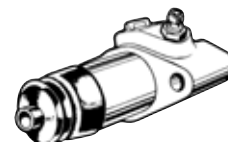
CILINDRO PRINCIPAL Y RECEPTOR (EMBRAGUE)
MASTER & SLAVE CLUTCH CYLINDERS

| Tractores Tractors | Cil. principal Master cyl. | Juego de rep. cil. principal Master cyl. repair kit | Juego de rep. cil. receptor slave cyl. repair kit |
|-------------------------------------|---------------------------------|--|--|
| CX50, CX60, CX70, CX80, CX90, CX100 | 25/226-4 (3129807R92) | 25/227-4 (N7602) | 25/229-4 (80318C91) |

Las referencias originales tienen un propósito identificativo.
 Nuestras piezas no son originales.

Part numbers are quoted for reference purposes only.
 Our parts and accessories are not original.



**FRENOS
BRAKES**

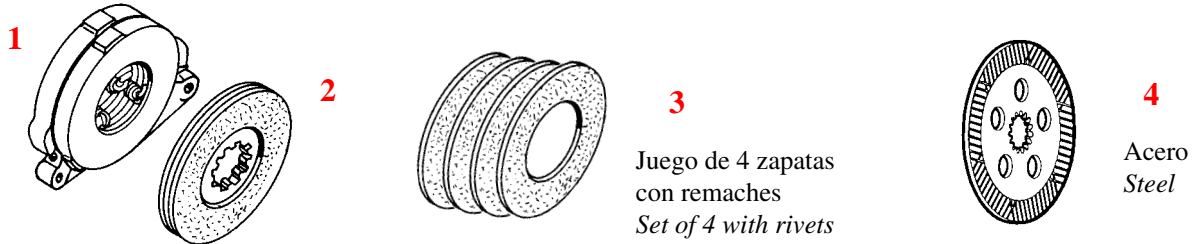

| Fig. | 1 | 2 | Ø | 3 | 4 |
|--|--|--|--|----------------------------------|---------------------------------|
| Tractores Tractors | DISCO DE FRENO (SECO) / BRAKE DISCS (DRY) | | | | |
| 423 | 25/417-16 (786460R21) | 25/420-16 (3064170R91) | Ø 165mm 10Z 35 x 41 | 25/421-16 (3040152R92) | |
| 433, 453, 533, 633 | | | | | |
| 523, 624, 433, 533, 633, 733, 614, 624, 634, 654, 724, 824 | 25/417-1 (787004R22) | 25/420-17 (3134665R91, 3229907R1) | Ø 178mm 10Z 35 x 41 | 25/421-17 (3069460R91) | |
| Según aplicación Depending fittings | | | Ø 143mm | 25/421-15 (751761R92) | |
| 644, 645, 743, 744, 745, 745XL, 844 | 25/417-20 (3142883R94) | | Ø 200mm Para disco / For disc 3225582R91 | 25/421-18 | |
| Tractores Tractors | DISCO DE FRENO (EN BAÑO DE ACEITE) / BRAKE DISCS (OIL BATH) | | | | |
| Series / series 44 et 45, 856 | | | Ø 226mm | | 25/420-5 (3145546R92) |
| 955, 1055, 956, 1056, + XL | | | Ø 255mm | | 25/420-7 (3220450R94) |
| Importante : Utilizar solo aceite "HYTRAN" / Important : Use only HYTRAN oil | | | | | |



**CILINDRO PRINCIPAL (FRENO)
MASTER BRAKE CYLINDERS**

| Tractores Tractors | Cilindro principal Master cyl. | Juego de reparación Repair kit |
|---------------------------------|-----------------------------------|-----------------------------------|
| C50, C60, C70, C80, C90, C100 | 25/410-15 (1287843C92) | 25/411-13 (1288228C1) |
| Seria / serie XL (4 cil./ cyl.) | 25/410-13 (3129643R91) | |
| 5120, 5130, 5140 | 25/410-12 (1287734C92) | 25/411-12 (1288229C1) |

Las referencias originales tienen un propósito identificativo.
Nuestras piezas no son originales.

Part numbers are quoted for reference purposes only.
Our parts and accessories are not original.



EJE TRASERO
REAR AXLE PARTS

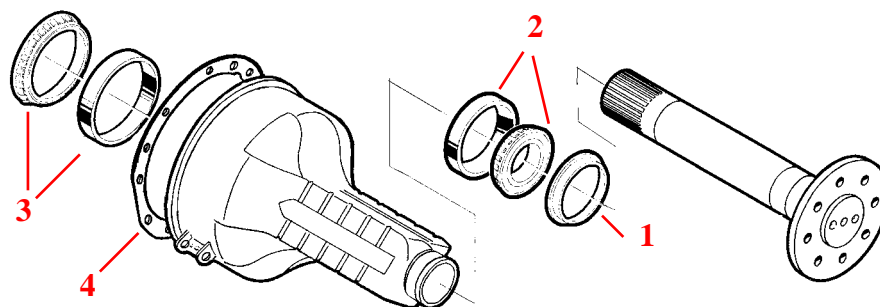

| Fig. | 1 | 2 | 3 | 4 |
|-------------------------------------|--|--|--|-------------------------------|
| Tractores <i>Tractors</i> | Retén <i>Oil Seal</i> | Rodamiento ext. <i>Outer bearing</i> | Rodamiento int. <i>Inner bearing</i> | Junta <i>Gasket</i> |
| 423, 433, 453, 533, 633, 733 | 25/371-14 (713172R1) (65x85x8mm) Anillos en fieltro / <i>Felt washer</i> | 25/372-12 (3114947R91) | 25/372-15 (3216105R91) | 25/385-5 (711193R1) |
| 644, 744, 844, 844S, 856 | 25/371-15 (711199R1) (65x85x13mm) Retén / <i>Oil seal</i> | 25/372-20 (712794R91) | 25/372-21 (ST 273A) | |
| 955, 956, 1055, 1056 | 25/371-17 (3220032R91) (115x140x13mm) | 25/372-23 (3220034R93) | 25/372-20 (712794R91) | |
| 946, 1046 | | 25/372-22 (3134990R91) | | |

EJE DE TOMA DE FUERZA
PTO SHAFT

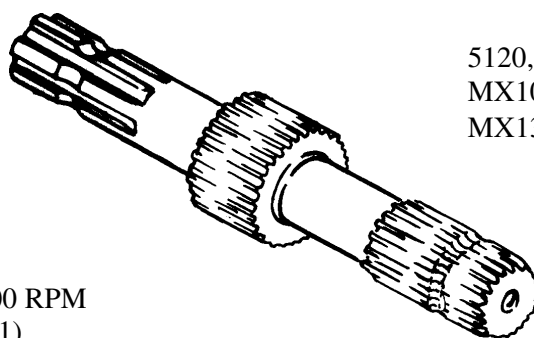

5120, 5130, 5140, 5150, MX80C, MX90C,
MX100C, MX100, MX110, MX120,
MX135, MX150, MX170

25/303-30 - 540-1000 RPM
(226823A1, 19995034C1)

Las referencias originales tienen un propósito identificativo.
Nuestras piezas no son originales.

Part numbers are quoted for reference purposes only.
Our parts and accessories are not original.



PIEZAS PARA EL EJE DELANTERO
FRONT AXLE PARTS

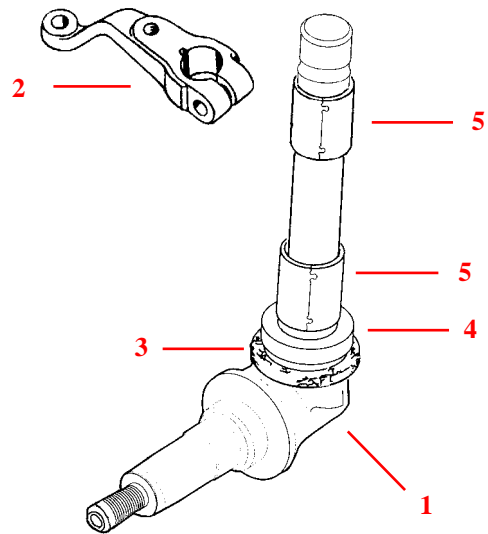
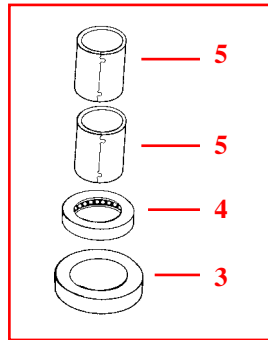
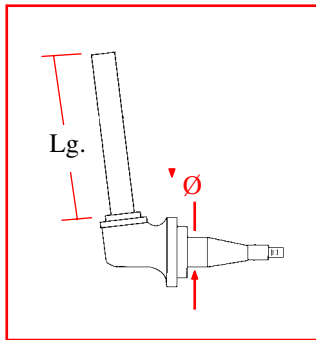

| Fig. | 1 | | Lg. Ø |
|---|---|---|---------------|
| | Mangueta / Spindle | | |
| Tractores Tractors | Drcha. / RH | Izq. / LH | |
| 644, 743, 744, 745, 844, 845, 946, 955, 956, 956XL, 1046, 1055, 1056, 1056XL, 1246 | 25/471-75 (3140079R94 (A), 3405600R1 (A), 3146323R95 (A), 3230080R1 (B), 3405602R1 (B)) | 25/470-75 (3140078R94 (A), 3405599R1 (A), 3146322R95 (A), 3230079R1 (B), 3405601R1 (B)) | 250mm 40mm |
| | 25/471-76 (3140077R93 (A), 3405614R1 (A), 3146321R95 (A), 3230093R1 (B), 3405616R1 (B)) | 25/470-76 (3140076R93 (A), 3146320R95 (A), 3405613R1 (A), 3230092R1 (B), 3405615R1 (B)) | 300mm 40mm |
| | 25/471-77 (3141510R93 (A), 3405618R1 (A), 3230098R1 (B), 3405620R1 (B)) | 25/470-77 (3141509R93 (A), 3405617R1 (A), 3230097R1 (B), 3405619R1 (B)) | 380mm 40mm |

| Fig. | 2 |
|--|---|
| Tractores Tractors | Biela direcc. Lever |
| 433, 533, 633, 733, 833, 644, 744, 844 (tracción simple/ 2 WD) Con dirección asistida With power steering | 25/480-17 (3141506R2) Ø 20mm |
| 644, 743, 744, 745, 844, 844S, 845, 945, 1055, 1056 (tracción simple/ 2WD) Con dirección asistida With power steering | 25/480-18 (3224268R3) Ø 22mm |

(A) Dirección manual / Manual steering
(B) Dirección asistida / Power steering

| Fig. | 3 | 4 | 5 | 6 |
|---|--------------------------|---|--|----------------------|
| Tractores Tractors | Retén Seal | Rodamiento Bearing | Casquillo Bush | Juego Rings kit |
| 523, 624, 724 | 25/476-13 (3131033R1) | 25/479-15 (3057058R91) (Bolas / Balls) | 25/477-16 (3057051R1) | 25/475-19 (B1268) |
| 323, 353, 383, 423, 453, 433 (⇨ 009581), 533 (⇨ 010654), 633 (⇨ 015892) | | | 25/477-15 (3059475R1) | 25/475-18 (B1267) |
| 433 (009582 ⇨), 533 (010655 ⇨), 633 (015893 ⇨), 733 | | 25/479-16 (3142132R1) (Bronce / Bronze) | 25/477-16 (3057051R1) | 25/475-20 (B1269) |
| 644, 743, 744, 745, 844, 844S, 845, 856, 946, 955, 956, 1046, 1055, 1056, 1246, 844XL, 845XL, 956XL, 1056XL Eje normal/ Standard front axle | | | 25/479-15 (3057058R91) (Bolas / Balls) | |
| 644, 743XL, 744, 745XL, 844XL, 844S, 845XL | | | | |
| 856, 955, 956, 1055, 1056 Eje reforzado / Heavy duty front axle | 25/476-14 (3232813R1) | 25/479-17 (3233850R91) | 25/477-17 (3232821R1) | 25/475-21 (B1270) |

Las referencias originales tienen un propósito identificativo.
Nuestras piezas no son originales.

Part numbers are quoted for reference purposes only.
Our parts and accessories are not original.



PIEZAS PARA EL EJE DELANTERO
FRONT AXLE PARTS (Continued)

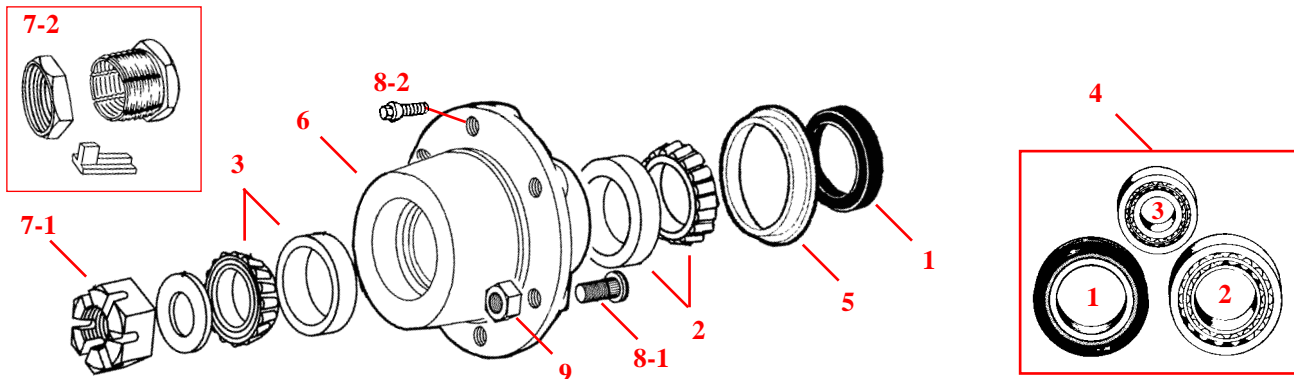

| Fig. | 1 | 2 | 3 | 4 | 5 |
|--|--|----------------------------------|---|---|--------------------------------|
| Tractores Tractors | Retén Oil seal | Rodamiento ext. Inner bearing | Rodamiento int. Outer bearing | Juego Bearings kit | Guía retén Wear ring |
| 523, 624, 724 | 25/461-19 (3057057R91) Ø 80,25mm 25/461-22 (3131013R1) Ø 86mm | 25/462-19 (663556R91) | 25/463-19 (3142103R91) Ø 80,25mm | 25/460-19 (B1040) Ø 80,25mm 25/460-21 (2222K) Ø 86mm | 25/464-4 (3131014R1) |
| 323, 353, 383, 423, 453 433 (⇨ 009581), 533 (⇨ 010654), 633 (⇨ 015892) | 25/461-20 (3131386R1) Ø 73,5mm | 25/462-13 (618022R91) | 25/463-20 (3142105R91) | 25/460-20 (2221K) | |
| 433 (009582 ⇨), 533 (010655 ⇨), 633 (015893 ⇨), 733 | 25/461-22 (3131013R1) Ø 86mm | 25/462-19 (663556R91) | 25/463-19 (3142103R91) (Rod. ext. / Outer bearing Ø 59mm) | 25/460-21 (2222K) (Rod. ext. / Outer bearing Ø 59mm) | 25/464-4 (3131014R1) |
| 644, 743, 743XL, 744, 745, 844, 844S, 845, 856, 946, 955, 956, 1046, 1055, 1056, 1246, 844XL, 845XL, 956XL, 1056XL Eje normal Standard front axle | | | 25/463-22 (3229813R91) (Rod. ext. / Outer bearing Ø 62mm) | 25/460-22 (2223K) (Rod. ext. / Outer bearing Ø 62mm) | |
| 856, 955, 956, 1055, 1056, Eje reforzado Heavy duty front axle | 25/461-23 (3232807R1) Ø 107,5mm | 25/462-23 (3232808R91) | 25/463-23 (3232820R91) | 25/460-23 (B1044) | 25/464-5 (3232806R1) |

| Fig. | 6 | 7 | 8 | 9 |
|--|--|---|---|---|
| Tractores Tractors | Cubo Rueda Front hub | Tuerca Nut | Tornillos Studs | Tuerca Nut |
| 433, 533, 633, 733 | | 70/452-1 (427639R1) 3/4" 7-1 | 25/446-11 (3137538R2) 8-2 | |
| 523, 624, 724 | | 70/457-5 (427645R1) 7/8" 7-2 | 25/446-15 (785612R1) 8-1 | 25/447-5 (933948R1) |
| 644, 743, 744, 745, 844, 844S, 845, 856, 946, 955, 956, 1046, 1055, 1056, 1246, 844XL, 845XL, 956XL, 1056XL Eje normal / Standard front axle | (Rodamiento ext. / Outer bearing Ø 59mm) (Rodamiento ext. / Outer bearing Ø 62mm) | | 25/450-19 (3131012R31) 25/450-20 (3229812R1) | 25/446-11 (3137538R2) 8-2 |
| 856, 955, 956, 1055, 1056 Eje reforzado / Heavy duty front axle | | | | |

Las referencias originales tienen un propósito identificativo.
Nuestras piezas no son originales.

Part numbers are quoted for reference purposes only.
Our parts and accessories are not original.



PIEZAS PARA EL EJE DELANTERO
FRONT AXLE PARTS (Continued)

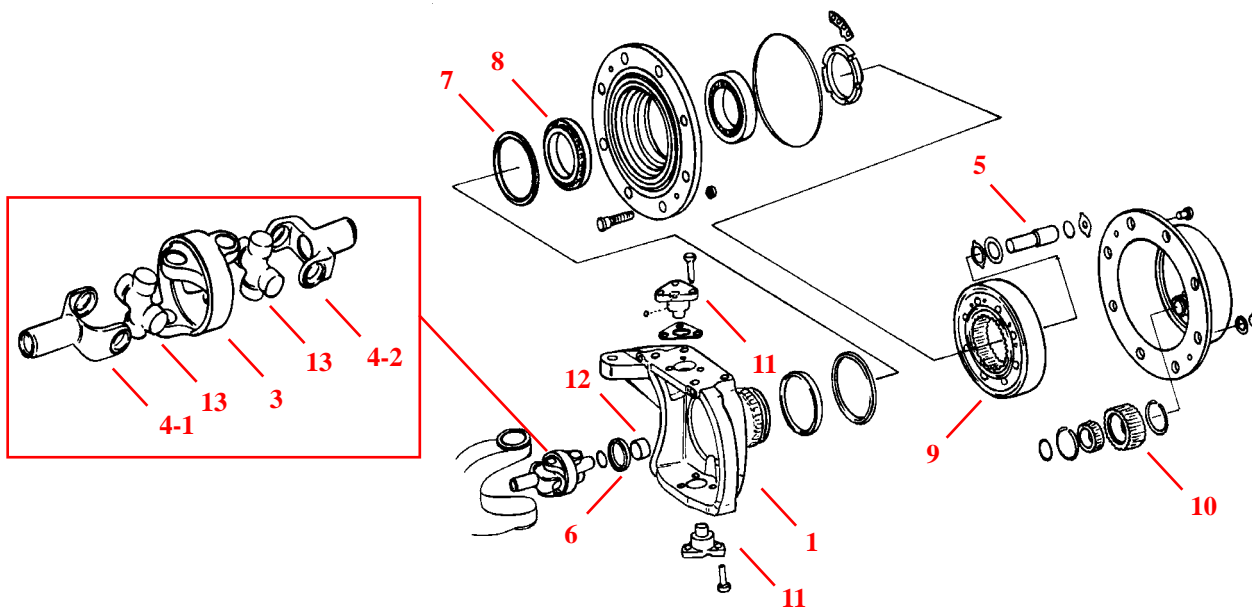

| ZF | APL 330 | APL335 |
|-----|--------------------------------------|---------------------------------------|
| | 743, 745S, 844S, 845, 856 (+XL) | 743, 745S, 844S, 845, 856 (+XL) |
| 1 | 25/6400-4 (IZQ) / (LH) (81413C1) | 25/6400-9 (IZQ) / (LH) (81291C1) |
| | 25/6400-5 (DCHA) / (RH) (81414C1) | 25/6400-10 (DCHA) / (RH) (81292C1) |
| 3 | 25/6404-1 (1342710C1) | |
| 4-1 | 25/6405-2 (1342712C1) | 25/6405-8 (1342717C1) |
| 4-2 | 25/6405-1 (1342713C) | 25/6405-9 (1342716C1) |
| 5 | 25/6406-8 (81435C1) | 25/6406-9 (81320C1) |
| 6 | 25/6407-6 (81411C2) | 25/6407-5 (81288C2) |
| 7 | 25/6408-7 (1964235C1) | |
| 8 | 25/6410-8 (81312C2) | |
| 9 | 25/6430-10 (81414C1) | 25/6430-4 (81319C1) |
| 10 | 25/6431-8 (81325C1) | |
| 11 | 25/6450-1 (81428C1) | 25/6450-3 (81305C1) |
| 12 | 25/6462-2 (81429C2) | 25/6462-8 (8136C2) |
| 13 | 25/6403-14 (1342711C1) | |

Las referencias originales tienen un propósito identificativo.
Nuestras piezas no son originales.

Part numbers are quoted for reference purposes only.
Our parts and accessories are not original.



PIEZAS PARA EL EJE DELANTERO
FRONT AXLE PARTS (Continued)

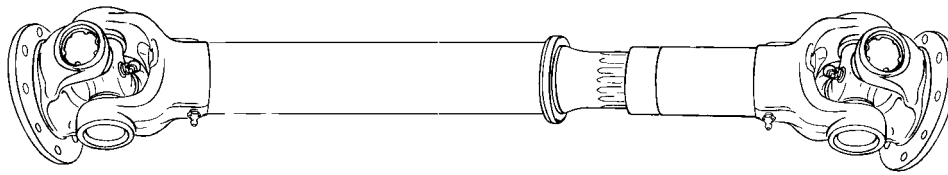

| Tractores Tractors | Eje ZF ZF axle | Longitud Length | Eje cardan Propeller shaft | OEM |
|---|----------------------|--------------------|-------------------------------|------------|
| 644, 743, 743XL, 744, 745S, 745XL, 844, 844S, 844XL, 856XL | APL.3052 | 1370 - 1430mm | 25/6491-9 | 3223350R91 |
| | | 1530 - 1590mm | 25/6491-10 | 3223354R92 |
| 743XL, 745XL, 844XL, 856XL | APL.1351 APL.1551 | 1040 - 1455mm | 25/6491-11 | 3148646R92 |
| | | 1208 - 1635mm | 25/6491-12 | 3148647R92 |
| 955, 955XL, 1055, 1055XL | APL.3052 | 1735 - 1835mm | 25/6491-6 | 3221117R92 |
| | | 1775 - 1835mm | 25/6491-7 | 3221116R92 |
| | APL.1552 | 1830 - 1890mm | 25/6491-8 | 3230179R92 |

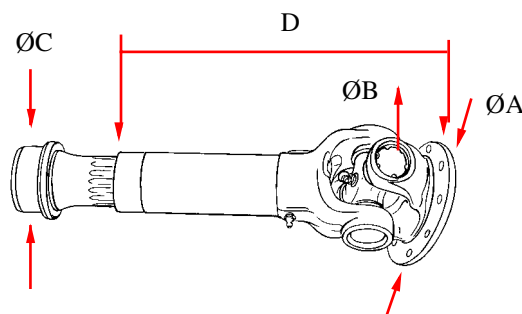

| EJE DEL PUENTE DELANTERO FRONT AXLE SHAFT | | ØA | ØB | ØC | D |
|--|---|-------|------------|-------|--------|
| 25/64901K | Pont déporté/ offset ZF axle APL1351,1551,1552, 3052 | 120mm | 35 mm | 64 mm | 345 mm |
| 25/6490-2 | APL1552 | 120mm | 38 x 106mm | 63mm | |
| 25/6490-3 | 33 série / serie | 100mm | 30 x 89mm | 44mm | 225mm |

JUEGO DE REPARACIÓN PARA LA ROSCA DE LA MANGUETA
FRONT SPINDLE THREAD REPAIR KIT

70/457-2
(LN10-2)

Rosca/ Thread 3/4" x 18 UNF
423, 433, 533, 633, ...

70/457-5
(LN10-5)

Rosca/ Thread 7/8" UNF
523, 624, 724, séries/ series 44 & 45

La tuerca interior cónica se colla sobre la rosca deteriorada y se cierra con la rosca exterior.
The inner cone nut is screwed on the worn thread and is locked by the outer nut.

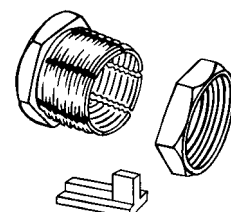

PIEZAS PARA EL EJE DELANTERO
FRONT AXLE PARTS (Continued)

BULÓN CENTRAL
CENTRAL PIN

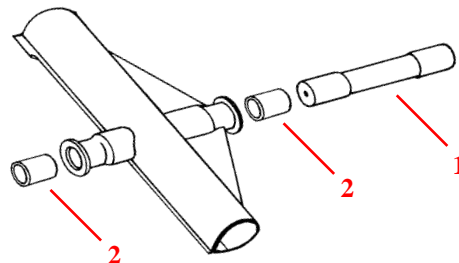

| Fig. | 1 | 2 |
|--|---|---|
| Tractores Tractors | Bulón Pin | Casquillo Bush |
| 433, 440, 533, 540, 633, 640, 644, 733, 740, 743, 743XL, 744, 745S, 745XL, 833, 840, 844, 844S, 844XL, 845, 845XL, 856XL, 940, 946, 955, 955XL, 956, 956XL, 1046, 1055, 1055XL, 1056, 1056XL, 1246, 1255, 1255XL, 1455, 1455XL Eje normal / <i>Standard axle</i> | 25/485-21 (3140082R1) Ø 40mm | 25/486-26 (3134952R1) 40x48x50mm |
| 743, 743XL, 745S, 745XL, 844S, 844XL, 845, 845XL, 856XL, 956, 956XL, 1056, 1056XL, 1255, 1255XL, 1455, 1455XL, 5120, 5130, 5140 Eje reforzado / <i>Heavy duty axle</i> | 25/485-22 (3232823R1) Ø 48mm | 25/486-27 (3232822R1) 48x58x50mm |
| 523, 553, 654, 724, 824, 624 | | 25/486-25 (3057064R1) 40x44x50mm |

DIRECCIÓN
STEERING

523, 553, 624, 654, 724, 824

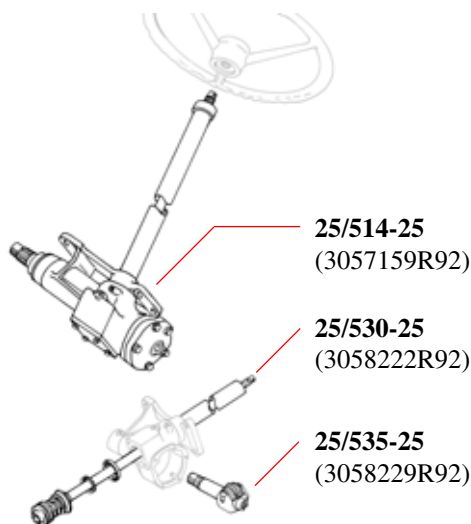

JUEGO DE DIRECCIÓN ASISTIDA
POWER STEERING KITS

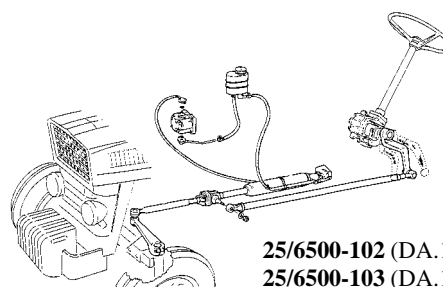

- 25/6500-102** (DA.102) - 523
- 25/6500-103** (DA.103) - 553
- 25/6500-104** (DA.104) - 554
- 25/6500-105** (DA.105) - 624, 654, 724
- 25/6500-106** (DA.106) - 433, 533, 633
- 25/6500-107** (DA.107) - 644, 744

Estos juegos están equipados con todas las piezas necesarias para la instalación.
Disponibilidad solo para pedidos en firme.

*These kits are supplied with all parts needed for installation.
Availability on receipt of firm order.*

Las referencias originales tienen un propósito identificativo.
Nuestras piezas no son originales.

*Part numbers are quoted for reference purposes only.
Our parts and accessories are not original.*



EJE DELANTERO Y CRUCETAS
FRONT AXLE - UNIVERSAL JOINTS

| Ref. n° Order nr | OEM | L x ø (mm) L x ø (mm) | Tipo eje delantero Front axle type | Fig. Fig. |
|---------------------|------------------------|--------------------------|--|--------------|
| 25/6403-13 | 100546A1 | 61,3 x 23,8mm | Type "Carraro" | C |
| 25/6403-14 | 1342711C1 | 70 x 27mm | ZF APL.335 | C |
| 25/6403-9 | 1342705C1 | 72 x 28mm | N.14411, ZF APL.335 | C |
| 25/6403-7 | 3230277R1 | 82 x 27mm | "LOBRO" ZF APL.1351 | B |
| 25/6403-8 | 3216691R1 | 83 x 30mm | ZF APL.1251 | D |
| 25/6403-15 | 1342708C1 | 86 x 32mm | ZF APL.345 | B |
| 25/6403-16 | 1975562C1 | 87 x 35mm | ZF APL.1552, APL.3052 | C |
| 25/6403-17 | 3223955R1 | 94 x 30mm | ZF APL.3050 | C |
| 25/6403-18 | 3224325R1 3148651R1 | 97 x 34mm | "ELBE" ZF APL.1552, APL.3052, APL.1551 | D |
| 25/6403-10 | 3133521R1 | 97 x 35mm | "LOBRO" ZF APL.3052 | A |
| 25/6403-19 | 3217467R1 | 106 x 38mm | ZF APL.3052, APL.1056 | D |
| 25/6403-20 | K965215 | 79 x 30 mm | APL.1351 | D |

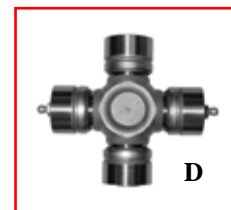
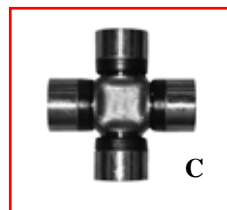
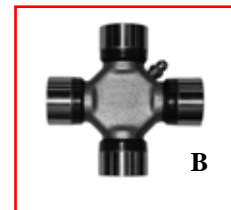
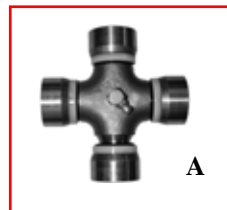

- (A) Engrasador central
centre greaser
- (B) Engrasador lateral
side greaser
- (C) Sin engrasador (sellado sin mantenimiento)
sealed long life (without greasser)
- (D) Con engrasador
greaser on nipple

TORNILLOS Y TUERCAS (LLANTA TRASERA)
STUDS AND SCREWS (REAR WHEEL)

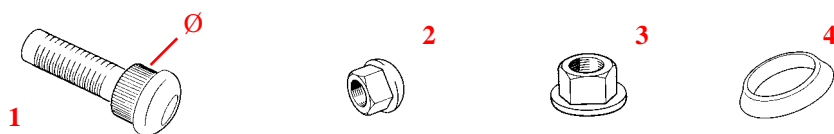

| Fig. | 1 | 2 | 3 | 4 |
|---|------------------------------------|--------------------------------------|---------------------------------------|--------------------------|
| Tractores Tractors | Tornillo Screw | Tuerca cónica Tapered nut | Tuerca plana Flat nut | Arandela Washer |
| 523, 624, 433, 533, 633, 733, 644, 744, 844, 844S | 25/440-8 (3058254R1) Ø 21 | 25/441-14 (933602R1) M18 x 1,5 | | |
| 433, 533, 633, 733, 856, 644, 744, 844, 844S | 25/440-9 (3399467R1) Ø 21 | | 25/441-8 (905514R1) M18 x 1,5 | 25/441-9 (3230348R2) |
| 955, 1055, 956, 1056 | 25/440-10 (3220372R2) Ø 22,5 | | 25/441-10 (3230784R1) M20 x 1,5 | 25/441-11 (3230875R2) |
| 1046DT, 1246DT | | 25/441-15 (934008R1) M20 x 1,5 | | |

Las referencias originales tienen un propósito identificativo.
Nuestras piezas no son originales.

Part numbers are quoted for reference purposes only.
Our parts and accessories are not original.



RÓTULAS Y ACOPLÉS DE DIRECCIÓN
TIE RODS & SOCKETS

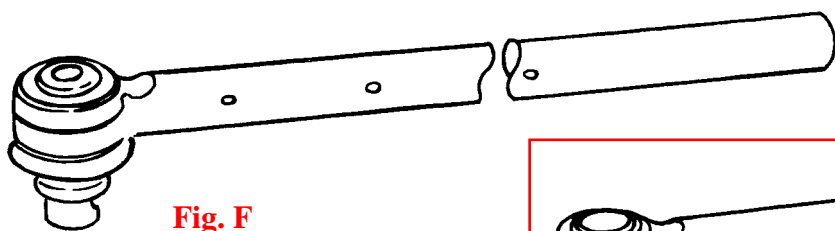

Fig. F

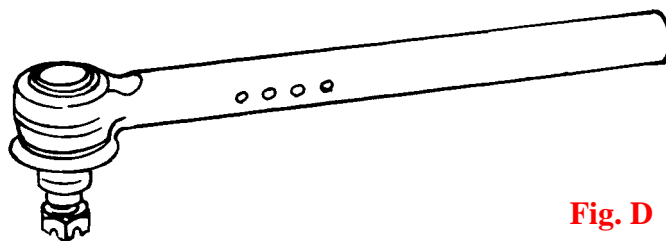

Fig. D

POSICIÓN / POSITION

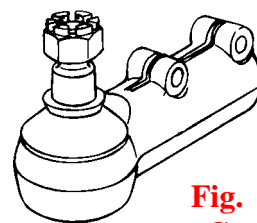
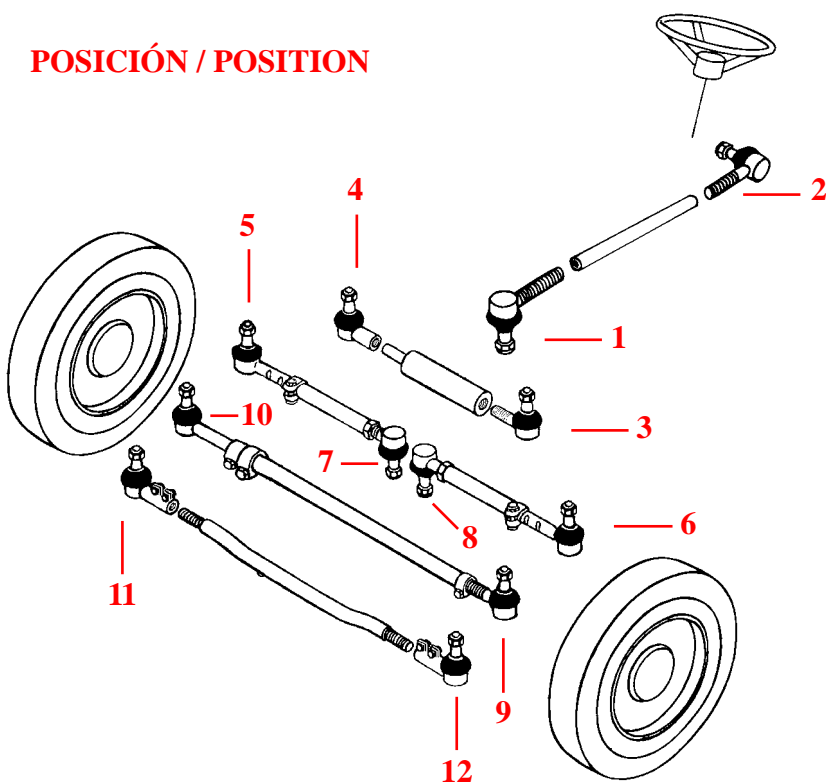

Fig. C

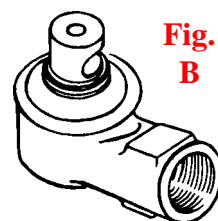

Fig. B

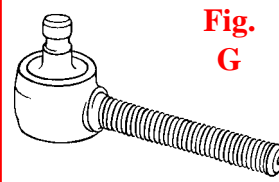

Fig. G



Fig. H

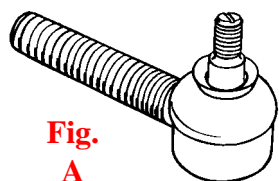

Fig. A

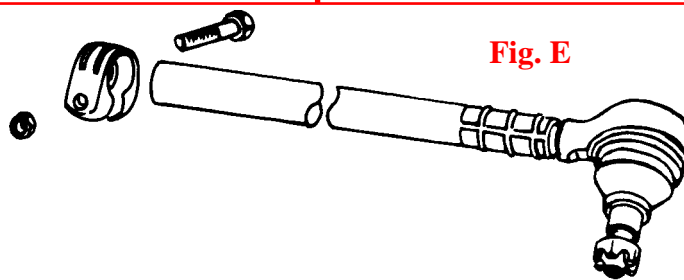

Fig. E

Nota / Note : M.22D
F.20G

Rótula macho M.22 rosca drcha. / Tie rod male M.22 right thread
Rótula hembra F.20 rosca izq. / tie rod female F.20 left thread

Las referencias originales tienen un propósito identificativo.
Nuestras piezas no son originales.

Part numbers are quoted for reference purposes only.
Our parts and accessories are not original.



RÓTULAS Y ACOPLES DE DIRECCIÓN

TIE RODS & SOCKETS (CONTINUED)

Ver página CIH-28 para figuras y posiciones/ *Figures & position, see page CIH-28*

| Tractores <i>Tractors</i> | | OEM | Fig. | Posición <i>Position</i> | Rosca <i>Thread</i> | Longitud <i>Length</i> | Cono <i>Cone</i> | Ø bulón cilíndrico <i>Side bolt fitting</i> |
|--|--------------------------------------|------------------------|------|-----------------------------|------------------------|--|---------------------|--|
| TRACTORES CON DOBLE TRACCIÓN SIMPLE, DIRECCIÓN MANUAL 2 WHEEL DRIVE TRACTORS WITH MANUAL STEERING | | | | | | | | |
| D.320, D.322, D.324, D.326, D.430, D.432, D.436, D.439, D.440 | 25/495-70 | 716195R91 717678R91 | A | 9 | M.16D | 95 | 14,5/16 | |
| 323, 353, 423 | 25/491-22 | 3131021R2 | G | 1 | M.20G | 65 | 16/18 | Ø 14 |
| | 25/492-22 | 3131016R1 | | 2 | M.18D | | | |
| | 25/497-12 | 3058214R91 | 7+8 | | 90 | | | |
| | 25/495-23 | 3058213R91 | D | 5+6 | | L = 385 Ø 18 | 14/16 | |
| 523, 553, 624, 724 | 25/492-16 | 3058207R92 | A | 2 | M.18D | 65 | 14/16 | Ø 14 |
| | 25/497-12 | 3058214R91 | G | 7+8 | | 90 | | |
| | 25/491-15 (523) | 3058208R91 | A+E | 1 | | 725 | 14/16 | |
| | 25/491-16 (624, 724) | 3058210R91 | | | | 845 | | |
| | 25/495-23 | 3058213R91 | D | 5+6 | | L = 385 Ø 18 | | |
| 433, 533, 554, 633, 733 | 25/492-17 | 3147510R1 | A | 2 | M.20D | 95 | 14/16 | |
| | 25/497-13 | 3148926R1 | | 7+8 | | | | |
| | 25/491-17 | 3148925R1 | D | 1 | | L = 270 Ø 22 (4 trous/ holes) | 14/16 | |
| | 25/495-24 (433, 533, 554, 633) | 3148923R1 | | 5+6 | | L = 725 Ø 22 | 16/18 | |
| | 25/495-25 (733) | 3401843R1 | | F | | L = 620 Ø 22 | | Ø 20 |
| 644, 743, 744, 844, 844S | 25/492-17 | 3147510R1 | A | 2 | M.20D | 95 | 14/16 | |
| | 25/497-13 (A) | 3148926R1 | | 7+8 | | | 16/18 | |
| | 25/497-14 (B) | 3223997R1 | | | M.24D | | 18/20 | |
| | 25/491-18 | 3147525R1 | D | 1 | | L = 270 Ø 22 | 16/18 | |
| | 25/495-24 (A) | 3148923R1 | | 5+6 | | L = 725 Ø 22 | | |
| | 25/495-27 (B) | 3223995R1 | | | | L = 725 Ø 16 | 18/20 | |

(A) : 644 (⇨ 010067), 744 (⇨ 008669), 844 (⇨ 005275), 844S (⇨ 010500)

(B) : 644 (010068 ⇨), 744 (008670 ⇨), 844 (005276 ⇨), 844S (010501 ⇨)

Las referencias originales tienen un propósito identificativo.
Nuestras piezas no son originales.

*Part numbers are quoted for reference purposes only.
Our parts and accessories are not original.*



"THE RELIABLE SERVICE"



RÓTULAS Y ACOPLES DE DIRECCIÓN
TIE RODS & SOCKETS (CONTINUED)

Ver página CIH-28 para figuras y posiciones/ *Figures & position, see page CIH-28*

| Tractores Tractors | | OEM | Fig. | Posición Position | Rosca Thread | Longitud Length | Cono Cone | Ø bulón cilíndrico Side bolt fitting |
|---|---------------|--------------------------|------|----------------------|-----------------|--------------------|--------------|---|
| TRACTORES CON DOBLE TRACCIÓN SIMPLE, DIRECCIÓN ASISTIDA 2 WHEEL DRIVE TRACTORS WITH POWER STEERING | | | | | | | | |
| 523, 624, 724 | 25/581-3 | 3059432R1 | A | 3 | M.18D | 100 | 16/18 | |
| | 25/581-4 | 3059433R1 | B | 4 | F.22D | 70 | | Ø 18 |
| 433, 533, 633, 733, 833 | 25/497-13 | 3148926R1 | A | 9 | M.20D | 95 | 16/18 | |
| | 25/581-5 | 3141530R91 | | 3 | M.22D | | 16/18 | |
| | 25/581-6 | 3141532R93 | B | 4 | F.20D | 70 | | Ø 20 |
| | 25/495-26 | 3217563R1 | F | 10 | | L = 725 Ø 22 | | Ø 20 |
| 644, 743, 744, 745 (+ XL) | 25/497-13 (A) | 3148926R1 | A | 9 | M.20D | 95 | 16/18 | |
| | 25/497-14 (B) | 3223997R1 | | | M.24D | | 18/20 | |
| | 25/581-5 | 3141530R91 | | 3 | M.22D | | 16/18 | |
| | 25/581-6 | 3141532R93 | B | 4 | F.20D | 70 | | Ø 20 |
| | 25/581-12 | 3224266R92 | | | | | | Ø 22 |
| | 25/495-26 (A) | 3217563R1 | F | 10 | | 725 | | Ø 20 |
| | 25/495-28 (B) | 3223996R1 | | | | | | Ø 22 |
| 844, 844S, 845 (+ XL) | 25/497-13 (C) | 3148926R1 | A | 9 | M.20D | 95 | 16/18 | |
| | 25/497-14 (D) | 3223997R1 | | | M.24D | | 18/20 | |
| | 25/581-5 (C) | 3141530R91 | | 3 | M.22D | | 16/18 | |
| | 25/581-11 (D) | 3224265R92 3230099R91 | | | M.24D | | 18/20 | |
| | 25/581-6 (C) | 3141532R93 | B | 4 | F.20D | 70 | | Ø 20 |
| | 25/581-12 (D) | 3224266R92 | | | | | | Ø 22 |
| | 25/495-26 (C) | 3217563R1 | F | 10 | | L = 725 Ø 22 | | Ø 20 |
| | 25/495-28 (D) | 3223996R1 | | | | | | Ø 22 |
| 856 | 25/497-14 (E) | 3223997R1 | A | 9 | M.24D | 95 | 18/20 | |
| | 25/581-11 (E) | 3224265R92 3230099R91 | | 3 | | 100 | | |
| | 25/497-15 (F) | 3232877R92 | | 9 | | M.28D | | 115 |
| | 25/581-12 (E) | 3224266R92 | B | 4 | F.20D | 70 | | Ø 22 |
| | 25/581-16 (F) | 3233186R91 | C | | F.22D | 110 | 24/26 | |
| | 25/495-28 (E) | 3223996R1 | F | 10 | | 725 | | Ø 22 |

Las referencias originales tienen un propósito identificativo.
Nuestras piezas no son originales.

Part numbers are quoted for reference purposes only.
Our parts and accessories are not original.



"THE RELIABLE SERVICE"



RÓTULAS Y ACOPLERES DE DIRECCIÓN
TIE RODS & SOCKETS (CONTINUED)

Ver página CIH-28 para figuras y posiciones/ *Figures & position, see page CIH-28*

| Tractores Tractors | | OEM | Fig. | Posición Position | Rosca Thread | Longitud Length | Cono Cone | Ø bulón cilíndrico Side bolt fitting |
|---|------------------|------------|------|----------------------|-----------------|--------------------|--------------|---|
| TRACTORES CON DOBLE TRACCIÓN SIMPLE, DIRECCIÓN ASISTIDA 2 WHEEL DRIVE TRACTORS WITH POWER STEERING | | | | | | | | |
| 946, 955, 956, 1046, 1055, 1056, 1246, 1255, 1255XL | 25/497-13 (E)(I) | 3148926R1 | A | 9 | M.20D | 95 | 16/18 | |
| | 25/497-14 (F)(J) | 3223997R1 | A | 9 | M.24D | 95 | 18/20 | |
| | 25/581-11 (F) | 3224265R92 | A | 3 | M.24D | 100 | 18/20 | |
| | 25/497-15 (F) | 3232877R92 | A | 9 | M.28D | 115 | 20/22 | |
| | 25/581-12 (E) | 3224266R92 | B | 4 | F.20D | 70 | | Ø 22 |
| | 25/581-16 (F) | 3233186R91 | C | 4 | F.22D | 110 | 24/26 | |
| | 25/495-29 (E)(I) | 3148929R1 | F | 10 | | L = 500 Ø 20 | | Ø 20 |
| | 25/581-5 | 3141530R91 | A | 3 | M.22D | 95 | 16/18 | |
| 25/581-6 | 3141532R93 | B | 4 | F.20D | 70 | | Ø 20 | |

(E) : Montaje estándar/ *Standard fitting*
(I) : 955 (↔ 001422), 1055 (↔ 001484)

(F) : Montaje reforzada/ *Heavy duty axle*
(J) : 955 (001423 ↔), 1055 (001485 ↔)

ACOPLES DE DIRECCIÓN
STEERING COUPLINGS

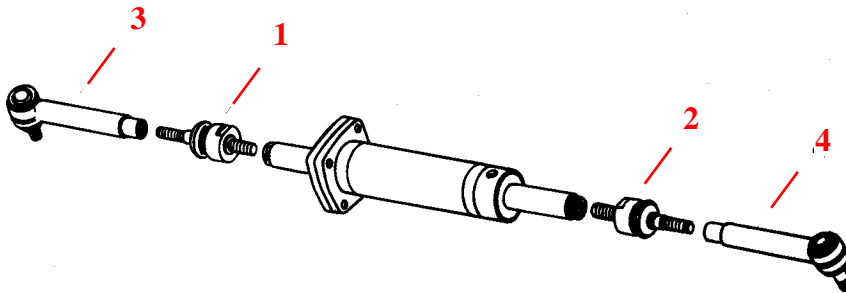

| Fig. | 1 | 2 | 3 | 4 |
|---|---|--------------------------------------|---|---|
| Tractores Tractors | Acoplamiento izq. Coupling (LH) | Acoplamiento dcha. Coupling (RH) | Horquilla izq Tie rod (LH) | Horquilla dcha. Tie rod (RH) |
| Maxxum 5120, 5130, 5140, 5150 | 25/497-44 (N14388) M24G-M22D | 25/497-17 (N14377) M24D - M22D | 25/495-67 (126144A1) M24G - 23,5x26,5 | 25/495-68 (126145A1) M24D - 23,5x26,5 |
| 743, 744, 745XL, 844, 845XL, 956, 1056,.... Para puente central / <i>With central axle</i> APL.330, APL.335 & APL.345 | 25/497-60 (1968463C1) M22D - M20D | | 25/495-60 (1968464C1) M22D - 20x22 | |

Las referencias originales tienen un propósito identificativo.
Nuestras piezas no son originales.

Part numbers are quoted for reference purposes only.
Our parts and accessories are not original.



RÓTULAS Y ACOPLES DE DIRECCIÓN
TIE RODS & SOCKETS (CONTINUED)

 Ver página CIH-28 para figuras y posiciones/ *Figures & position, see page CIH-28*

| Tractores Tractors | | OEM | Fig. | Posición Position | Rosca Thread | Longitud Length | Cono Cone | Ø bulón cilíndrico Side bolt fitting |
|--|------------------|------------|------|----------------------|-----------------|--------------------|--------------|---|
| TRACTORES CON DOBLE TRACCIÓN 4 WHEEL DRIVE TRACTORS | | | | | | | | |
| 433, 533, 633, 733, 833 | 25/581-7 (A) | 3141529R91 | A | 3 | M.30D | 110 | 23/26 | |
| | 25/581-9 (B) | 3221931R91 | | | M.24D | 105 | 20/22 | |
| | 25/581-8 (A) | 3141531R91 | H | 4 | F.20D | 75 | 18/20 | |
| | 25/581-10 (B) | 3221932R92 | | | | 65 | 20/22 | |
| | 25/497-21 (C) | 3217279R1 | A | 10 | M.24D | 105 | | |
| 644, 743, 744, 745, 844, 844S, 845, 856 | 25/581-7 | 3141529R91 | | 3 | M.30D | 110 | 23/26 | |
| | 25/581-14 | 3146035R93 | H | 4 | F.20D | 85 | 24/26 | |
| | 25/497-21 | 3217279R1 | A | 10 | M.24D | 105 | 20/22 | |
| | 25/497-23 | 3146733R1 | C | 11+12 | F.36D | 140 | 23/26 | |
| 946, 1046, 1246 | 25/581-7 | 3141529R91 | A | 3 | M.30D | 110 | | |
| | 25/581-17 | 3221270R91 | | | | 95 | 27/30 | |
| | 25/581-18 | 3221271R93 | H | 4 | F.24D | | | |
| | 25/581-8 (D) | 3141531R91 | | | | 75 | 18/20 | |
| | 25/581-14 (E) | 3146035R93 | | | | 85 | 24/26 | |
| | 25/497-24 (F) | 3140943R1 | C | 11+12 | F.36D | 150 | 27/30 | |
| | 25/497-23 | 3146733R1 | | | | 140 | 23/26 | |
| 955, 1055, 956, 1056, 1255, 1455 (+ XL) | 25/581-17 | 3221270R91 | A | 3 | M.30D | 95 | 27/30 | |
| | 25/497-22 | 3230364R1 | | 10 | M.24D | 125 | 26/24 | |
| | 25/581-18 | 3221271R93 | H | 4 | F.24D | 95 | 27/30 | |
| | 25/497-23 | 3146733R1 | C | 11+12 | F.36D | 140 | 23/26 | |
| | 25/497-24 | 3140943R1 | | | | 150 | 27/30 | |

(A) : 433 (↔ 002918), 533 (↔ 003405), 633 (↔ 003668)

(C) : 733

 (E) : Eje delantero n° 1519 ↔ / *Front axle n° 1519 ↔*

(B) : 433 (002919 ↔), 533 (003406 ↔), 633 (003689 ↔)

 (D) : Eje delantero ↔ n° 1518 / *Front axle ↔ n° 1518*

 (F) : Eje reforzado / *Heavy duty axle*

 Las referencias originales tienen un propósito identificativo.
 Nuestras piezas no son originales.

"THE RELIABLE SERVICE"

 Part numbers are quoted for reference purposes only.
 Our parts and accessories are not original.

BOMBAS HIDRAULICAS
HYDRAULIC PUMPS

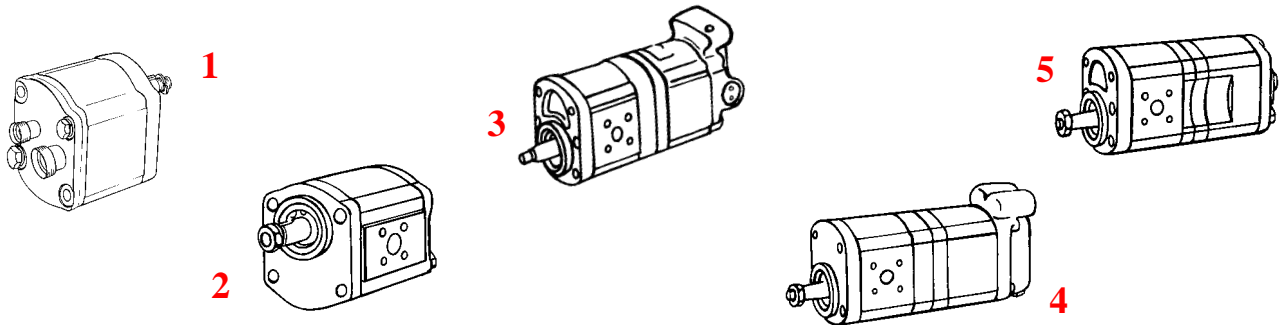

| Tractores Tractors | Bomba Pump | BOSCH | OEM | Flujo Flow | Fig. | Comentario Remarks |
|---|---|---|--------------------------|---------------|----------|---|
| 323, Serie D / serie | 69/565-19 (BOSCH) | 0.510.415.007 0.510.405.005 0.510.410.012 0.510.312.002 | 3054300R93 | 8 | 1 | Salidas traseras Rear outlets |
| 353, 383, 423, 433, 453, 523, 533, 624, 633, 644, 724, 734, 743, 744, 745, 824, 844, 845 | 69/565-4 (BOSCH) 69/566-4 (Bendix) | 0.510.415.311 0.510.415.301 0.510.415.303 0.510.415.306 0.510.410.315 | 3145248R93 3142097R91 | 8 | 2 | |
| <u>Hyd. ZF/ROSS</u> 523, 553, 624, 654, 724, 734, 824, 834 | 69/565-20 (BOSCH) | 0.510.465.322 0.510.465.304 0.510.465.300 | 3148938R92 3142096R91 | 8/8 | 3 | Con divisor de flujo, + válvula de presión, 2 salidas traseras / With flow divider and release valve, 2 rear outlets |
| <u>Hyd. DANFOSS</u> 523, 553, 624, 633, 724, 734, 743, 824, 834 | 69/565-21 (BOSCH) | 0.510.465.315 0.510.465.301 0.510.465.311 | 3145619R92 3142563R91 | 8/8 | 4 | Sin divisor de flujo, con válvula de presión, 2 salidas traseras Less flow divider and with release valve, 2 rear outlets |
| <u>Hyd. ZF</u> 433, 633, 644, 645, 733, 743, 744, 745, 833, 844, 845, 856 | 69/565-8 (BOSCH) 69/566-8 (Bendix) | 0.510.465.349 0.510.465.321 0.510.465.338 0.510.465.302 | 3147535R94 3216613R91 | 8/8 | 5 | Sin divisor de flujo, sin válvula de presión, 2 salidas traseras Less flow divider and less release valve, 2 rear outlets |
| 743XL, 745XL, 844XL, 845XL | 69/565-22 (BOSCH) | 0.510.465.340 | 1328655C91 1986961C1 | 8/8 | 5 | Sin divisor de flujo, sin válvula de presión, 1 salida trasera Less flow divider and less release valve, 1 rear outlet |
| 743XL, 745XL, 844XL, 845XL, 856XL Sens-O-draulic | 69/565-23 (BOSCH) 69/566-23 (Bendix) | 0.510.465.339 0.510.465.332 | 3401189R94 | 8/8 | 3 | Con divisor de flujo + válvula de presión, 2 salidas traseras With flow divider and release valve, 2 rear outlets |

Las referencias originales tienen un propósito identificativo.
Nuestras piezas no son originales.

Part numbers are quoted for reference purposes only.
Our parts and accessories are not original.



**BOMBAS HIDRAULICAS
HYDRAULIC PUMPS**

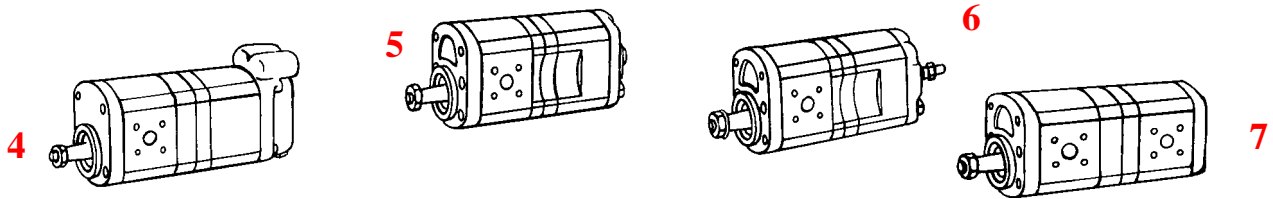

| Tractores Tractors | Bomba Pump | BOSCH | OEM | Flujo Flow | Fig. | Comentario Remarks |
|----------------------------------|--|---|--------------------------|---------------|----------|---|
| Hyd. DANFOSS 946, 1046, 1246 | 69/565-24 (BOSCH) | 0.510.565.314 | 3146446R93 3146450R91 | 11/8 | 4 | Sin divisor de flujo , con válvula de presión, 2 salidas traseras <i>Less flow divider and with release valve, 2 rear outlets</i> |
| 955, 956XL, 1055XL, 1056XL | 69/565-25 (BOSCH) 69/566-25 (Bendix) 69/567-25 (A) (BOSCH) | 0.510.565.361 0.510.565.330 1.517.222.395 | 3223932R94 | 11/8 | 6 | Sin divisor,, sin válvula de presión, 2 salidas traseras (1 macho, 1 hembra) <i>Less flow divider and less release valve, 2 rear outlets (1male, 1 female)</i> |
| 956XLA, 1056XLA | 69/565-27 (BOSCH) | 0.510.565.365 | 89880C91 | 11/8 | 5 | Sin divisor de flujo , sin válvula, 2 salidas traseras, 2 entradas / <i>Less flow divider and less release valve, 2 rear outlets, 2 inlets</i> |
| 956XL, 1056 XL Sens-O-draulic | 69/565-28 (BOSCH) 69/566-28 (Bendix) | 0.510.565.362 0.510.565.321 | 3220221R93 | 11/8 | 5 | Sin divisor de flujo , sin válvula, 2 salidas traseras, 1 entrada / <i>Less flow divider and less release valve, 2 rear outlets, 1 inlet</i> |
| Hyd. ZF 1255, 1455XL | 69/565-29 (BOSCH) 69/567-29 (A) (BOSCH) | 0.510.555.306 0.510.555.303 | 3226942R93 | 14/11 | 7 | Sin divisor de flujo, sin válvula, paro con franja de union. / <i>Less flow divider and less release valve, and counter flange</i> |

(A) Bomba del elevador suelto / *Separate hyd. lift pump*

**JUEGO CILINDROS DE AYUDA
ADDITIONAL HYD. LIFT RAM KITS**

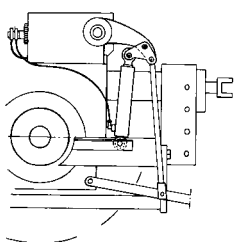

25/770-3 644, 645, 743, 744, 745, 844, 845,
955, 946, 956, 1046, 1055

25/770-4 Mismas aplicaciones con cabina XL
Same applications with XL cab

25/772-3 Cilindro suelto
Separate ram cyl.

**ACOPLAMIENTO HIDRÁULICO
HYDRAULIC COUPLINGS**

**Enchufe rapido
Brake**



69/906-5
(737606R1)



69/905-5
(3131463R91)

Las referencias originales tienen un propósito identificativo.
Nuestras piezas no son originales.

Part numbers are quoted for reference purposes only.
Our parts and accessories are not original.



HIDRÁULICOS
HYDRAULIC

DISTRIBUIDORES HIDRÁULICOS ADAPTABLES
ADAPTABLE HYDRAULIC SPOOL VALVES

Aplicaciones / Applications

423, 433, 453, 523, 533, 624,
633, 644, 724, 733, 743, 744,
745S, 824, 833, 844, 844S, 845

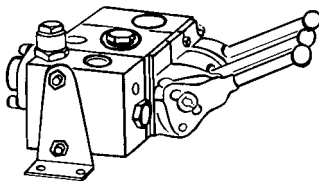

69/7600-5

Elemento simple efecto montaje tipo BOSCH
BOSCH type slice, single acting

69/7600-6
(3054388R91)

Elemento simple efecto montaje tipo BOSCH
Con posibilidad de bloqueo de alzamiento
BOSCH type slice, single acting
With optional operating lever locking position

69/7600-7
(3059907R91)

Elemento doble efecto montaje tipo BOSCH
BOSCH type slice, double acting

69/7600-15

Elemento doble efecto montaje tipo BOSCH con posición flotante
BOSCH type slice, double acting with floating position

69/7608-1

Placa de entrada
Inlet slice

69/7608-2

Placa de entrada con presión continua
Inlet slice with continuous pressure

69/7609-1
(3225760R1)

Palanca para / *Lever for 69/7600-6*

69/7609-7

Palanca para / *Lever for 69/7600-5*

69/7610-1

Juego de reparación
Repair kit

(1)

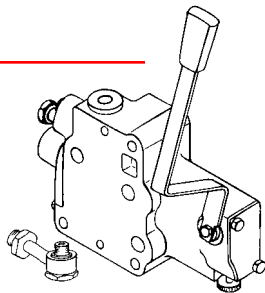

Aplicaciones / Applications

946, 1046, 1246, 1255, 1455

25/7600-8 (1)

Elemento intercambiable simple/doble efecto
montaje tipo BOSCH con adaptador y palanca
BOSCH type slice, single/double acting changeover
with adaptor and lever

25/7612-1

Adaptador/ *Adaptor*

25/7609-2

Palanca / *Lever*

Aplicaciones / Applications

743XL, 856XL, 956XL, 1056XL, 1255XLA, 1256XL, 1455XL, 1455XLA

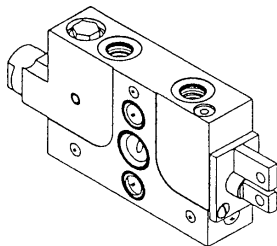

25/7600-11

(0521609001, 0521609005,
0521609009, 0521609013,
0521609019, 0521609021,
0521609022, 0521609053)

Elemento intercambiable simple/doble efecto, 4 posiciones
Single/double acting changeover, 4 positions

Rosca / *Thread* : M22x1,5

Flujo / *Flow* : 70l/min

Presión, / *Pressure* : 220 bars

Sin cable de mando / *Less operating cable*

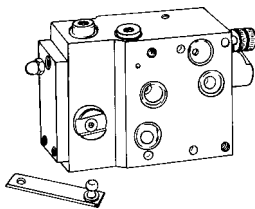

Aplicaciones / Applications

745, 755, 855, 856, 955, 956, 1055, 1056, 1156, 1256

25/7600-13

Elemento intercambiable simple/doble efecto
Single/double acting changeover

VALVULA DE ELEVACIÓN HIDRÁULICO
HYDRAULIC VALVE

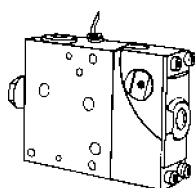

69/7611-5
(89845C1,
0521704116)

1255, 1255XL, 1455, 1455XL

69/7611-1
(3147440R91, 3140895R92
0521704075, 0521704080, 0521704101
0521704104, 0521704110)

946, 1046, 1246

Las referencias originales tienen un propósito identificativo.
Nuestras piezas no son originales.

Part numbers are quoted for reference purposes only.
Our parts and accessories are not original.



**CAJA NIVELADORA
LEVELLING BOX ASSEMBLY**

**CAJA NIVELADORA
LEVELLING BOX ASSEMBLY**

Caja niveladora/ Complete levelling box : **25/760-33**
(R444K)

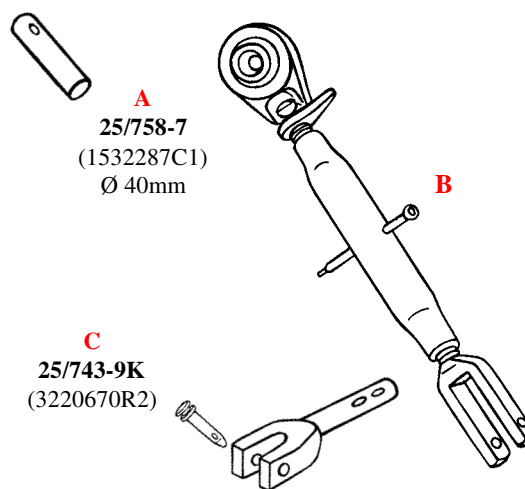
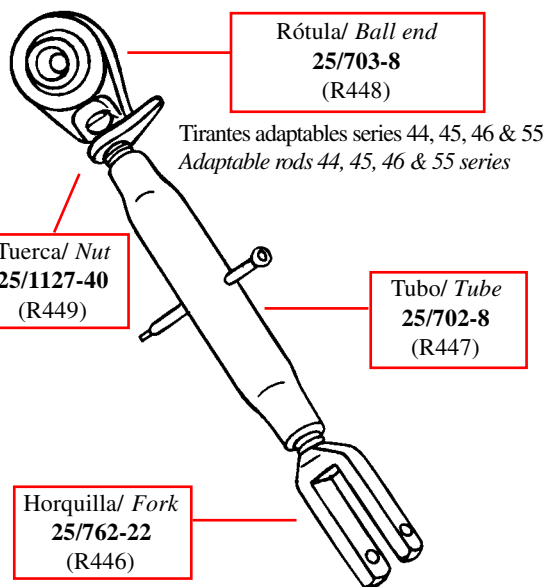

25/760-31K (R445KA) **Juego con / Kit includes :**
(A) pasador
(A) top pin to ball end
(B) barilla tensora / linkage rod
(B) fork with pin and washer
(C) horquilla con pasador y arandela
(C) fork with pin and washer

Para tractores series 44, 45, 46 & 55
For fitting on tractors 44, 45, 46 & 55 series

**CAJA NIVELADORA
LEVELLING BOX ASSEMBLY**

Completa/ Complete
25/760-25
(R443)

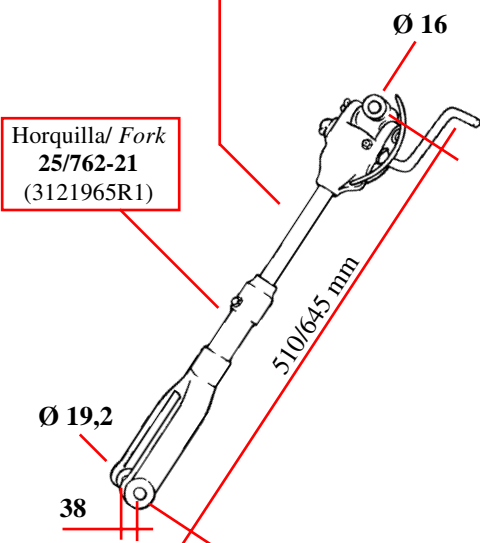

Completa/ Complete
25/760-32
(R438)

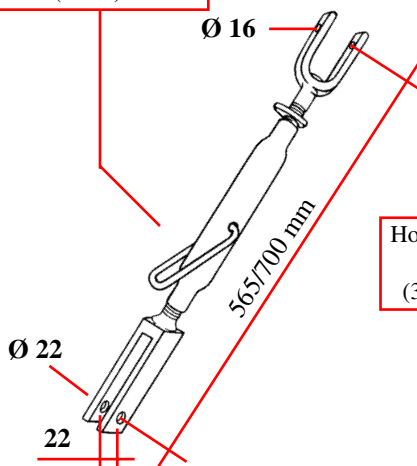

Completa/ Complete
25/760-28
(R436)

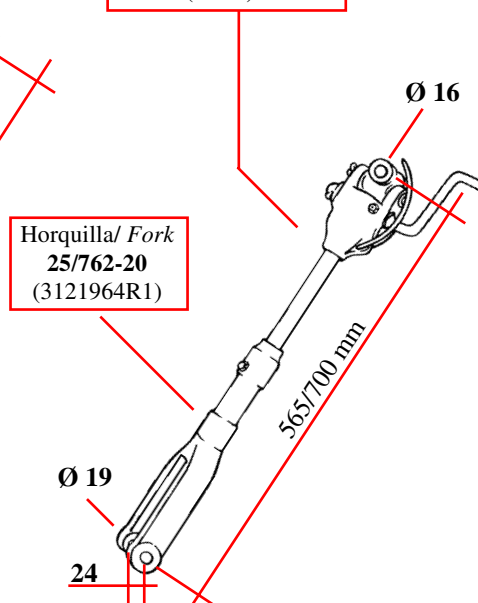

423, 453, 523, 633, 724, 733, 824, ...

Las referencias originales tienen un propósito identificativo.
Nuestras piezas no son originales.

Part numbers are quoted for reference purposes only.
Our parts and accessories are not original.



ESTABILIZADORES Y COMPONENTES
STABILISERS & COMPONENTS

25/743-9K
(3220670R2)
Ø 28, L= 60 & 78mm

25/748-2
(3226000R1)

25/746-7
(3140714R2)

25/747-4
(3146372R92)

25/743-8
(3140005R1)
Ø 28, L= 42mm

25/744-7
(3140713R2)

Series/ series 44, 45, 46, 55 & 56

25/740-18 Estabilizador completo (con horquilla 25/743-8)
(3146371R94) Complete stabiliser (with yoke 25/743-8)

25/740-19 Estabilizador completo (con horquilla 25/743-9K)
(R314K) Complete stabiliser (with yoke 25/743-9K)

25/740-20 Estabilizador corto compuesto de figuras Nos 1, 2 et 3
(1965995C91) Short stabiliser body including parts 1, 2 and 3

CADENA ESTABILIZADORA
CHAIN STABILISERS

68/740-17
(AT6410KP)

Según aplicación
Depends fitting

Longitud / Length : 500 ⇄ 610mm

Para más información ver la gama completa en la sección 1 del catálogo. / For further details, see the complete range in part 1 of the catalogue.

PASADORES TERCER PUNTO
TOP LINK PINS

25/704-11 (3137660R1) Cat. 1 + 2, Lg tot. 175 mm

25/704-12 (528084R1) Cat. 1 + 2, Lg tot. 157 mm

25/704-13 (528081R1) Cat. 1 + 2, Lg tot. 132 mm

25/719-5 (3057362R1) Casquillo Ø 43, largo 35 mm
Bush Ø 43, width 35 mm

25/719-6 (3057361R1) Casquillo Ø 43, largo 44,5 mm
Bush Ø 43, width 44,5 mm

TECER PUNTO / TOP LINK

25/1101-12K
(3141807R92)

Longitud cerrado / Shorter length : 490mm
Con rótulas de Ø 19 y Ø 25
1 side Ø 19 with pin, 1 side Ø 25

644, 645, 743, 744, 745, 844, 844S, 845

RÓTULAS FINALES PARA BRAZO DE ELEVACIÓN INFERIOR
WELD-ON ENDS FOR LIFT ARM

68/715-6 (AT38/26) Con rótula de Ø 25,4 / Tractor side Ø 25,4
E : 110mm

68/715-7 (AT28/25) Con rótula de Ø 25,4 / Tractor side Ø 25,4
E : 80mm

68/715-8 (AT28/96) Con rótula de Ø 28 / Implement side Ø 28
E : 108mm

Las referencias originales tienen un propósito identificativo.
Nuestras piezas no son originales.

Part numbers are quoted for reference purposes only.
Our parts and accessories are not original.



**ALTERNADORES
ALTERNATORS**

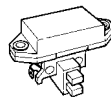
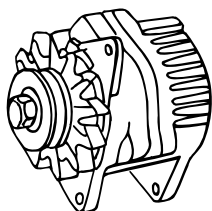

| Tractores Tractors | Alternador Alternator | Capacidad Capacity | Comentario Comment | OEM | Regulador Control box |
|--|-----------------------------------|-----------------------|---|------------|---------------------------------|
| 433, 533, 633, 733, 833 | 62/920-38 (15/1116) (W) | 14V., 33 Amp. | | 3218577R91 | 62/919-13 (205/01007) |
| 321, 431, 531, 554, 644, 743, 744, 745, 844, 844S, 845, 856, 946, 955, 956, 1046, 1055, 1056, 1246, 1255, 1455 + tipo/ type XL | 62/920-23 (K552) (W) | 14V., 33 Amp. | VALEO Fijación con tornillos <i>Plug connections</i> Sujección con tornillos <i>Screw connections</i> | 3218239R91 | 62/919-13 (205/01007) |
| | 62/920-84 (510E249) | 14V., 45 Amp. | | 432988A | 62/919-20 (505E079) |
| | 62/920-62 (15/1133) (W) | 14V., 55 Amp. | | | 62/919-21 (205/05122) |
| | 62/920-64 (15/1215) (W) | 14V., 65 Amp. | | 3218544R91 | 62/919-21 (205/05122) |
| MAXXUM 5120, 5130, 5140, 5150 CS68, 75, 78, 86, 94 MX80C, 90C, 100, 100C, 110, 120, 135, 150, 170 | 62/920-72 (15/1953) (W) | 14V., 65 Amp. | Correa/ Belt 17 mm | A187873 | 62/919-21 (205/05122) |
| | 62/920-76 (15/8999) (W) | 14V., 85 Amp. | | A187623 | 62/919-21 (205/05122) |
| Todos tipos All models | 62/920-65 (15/1230) | 14V., 55 Amp. | Montaje izq. o drcha. <i>LH or RH fitting</i> | 3218544R91 | 62/919-21 (205/05122) |
| | 62/920-34 (15/5599) (W) | 14V., 65 Amp. | | | |
| CS110, CS120, CS130, CS150 | 62/920-71 (15/1675) | 14V., 95 Amp. | | 11201675 | |

(W) Conexión eléctrica / *Electrical connection*

**REPUESTOS PARA DINAMOS Y ALTERNADORES TIPO «BOSCH»
MISCELLANEOUS PARTS FOR «BOSCH» DYNAMO & ALTERNATOR**

62/913-5
(1.107.014.144)

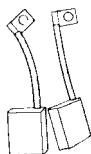

Juego de escobillas para dinamo "BOSCH"
Brush set for dynamo "BOSCH"

62/923-5
(1.127.014.011)

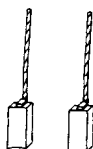

Escobillas para alternador
Brushes for alternators

REGULADORES / CONTROL BOX

62/919-15
(0.190.601.006)

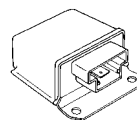

Tipo / Type "AD.1"
Regulador / *Electronical*

62/919-13
(0.192.052.005)

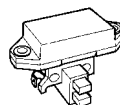

Tipo / Type 14V
Incorporado / *incorporated*



Para más información ver la gama completa en la sección 1 del catálogo. / *For further details, see the complete range in part 1 of the catalogue.*

Las referencias originales tienen un propósito identificativo.
Nuestras piezas no son originales.

Part numbers are quoted for reference purposes only.
Our parts and accessories are not original.



MOTORES DE ARRANQUE
STARTER MOTORS

Lanceur : 11Z = 11 dientes
Fixation : Número de agujeros
R : montaje drcha.
L : montaje izq.

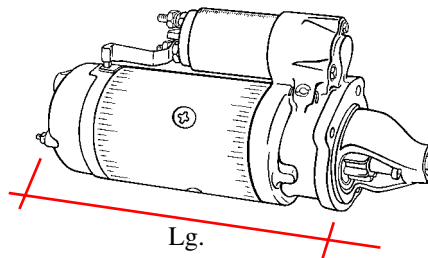

Drive : 11Z = 11 teeth
Fitting : Numbers of holes
R : RH mounting
L : LH mounting

| Tractores Tractors | REF. N° ORDER N° | Transmisión Drive ass. | Fijación Fitting | Lg. sobresaliente Prominent length | Capacidad Capacity | OEM |
|---|--|---------------------------|---------------------|---------------------------------------|-----------------------|---------------------|
| 383, 433, 453, 533, 633, 733, 833 | 62/930-21 (15/00506 I-H) | 11Z | 3R | 254mm | 12V., 3,5 KW | 3228192R91 |
| | 62/930-55 (15/00705) (Iskra) | 11Z | 3R | 253mm | 12V., 3,1 KW | 3228192R91 |
| 523, 553, 554, 624, 644, 654, 724, 743, 744, 745, 824, 844, 845, 856, 946, 955, 956, 1046, 1055, 1056, 1246, 1255, 1455 (+XL) | 62/930-22 (R.3055414) | 9Z | 3L | 254mm | 12V., 3,5 KW | 3228193R91 |
| | 62/930-54 (15/00704) (Iskra) | 9Z | 3L | 228mm | 12V., 3,1 KW | 3228193R91 |
| Maxxum 5130, 5140, 5150, MX100, MX110, MX120, MX135 | 62/930-52 (15/30412) (Iskra) | 9Z | 3R | 254mm | 12V., 3KW | 114799A1 A187597 |
| CS110, CS120, CS130, CS150 | 62/930-43 (15/00692V) (Iskra) | 11Z | 3R | 243mm | 12V., 3KW | 133200009075 |

Repuestos para motor de arranque : ver sección 1
Spare parts for starter motors, see cat. 1



REPUESTOS PARA MOTORES DE ARRANQUE TIPO «BOSCH»
SPARE PARTS FOR «BOSCH» STARTER MOTORS

1

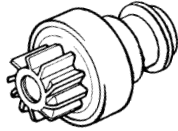

2

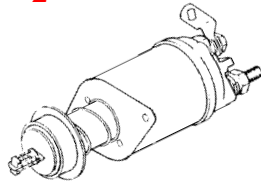

3



4

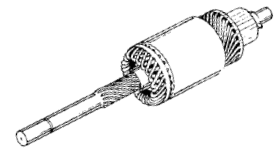

| Fig. | 1 | | 2 | 3 | 4 |
|---|-------------------------------------|--|-------------------------------------|---|---|
| Tractores Tractors | Transmisión Drive ass. | Comentario Comment | Automatic Solenoid | Juego de escobillas Brush set | Inducido Armature |
| 353, 383, 453 (71 ⇄ 73) | 62/939-32 (2.006.209.302) | 11 dientes / <i>teeth</i> | | | |
| 353, 383, 453 (7/71 ⇄ 3/73), 523 (6/65 ⇄ 12/71), 553, 624, 654, 724, 824, 946, 1046 (6/71 ⇄ 3/73), 1246 (4/73 ⇄ 1/74) | | Fijación 2 tornillos <i>Fixed 2 bolts</i> | 62/940-18 (0.331.401.001) | | |
| 523, 624 (12/67 ⇄ 12/71) | | Fijación 3 tornillos <i>Fixed 3 bolts</i> | 62/940-27 (0.331.401.008) | 62/933-8 20x26x9 (2.007.014.052) ⇄ 12/77 | |
| 553, 654, 724, 824, 946 (⇄ 3/73), 1246 (4/73 ⇄ 1/74) | 62/939-28 (2.006.209.301) | | | | |
| 353 (12/67 ⇄ 6/71), 553 (4/73 ⇄ 1/74), 554 (2/74 ⇄ 2/75), 644, 744 (1/74 ⇄ 12/77), 654, 724, 824, 834 (4/73 ⇄ 12/74), 844 (1/74 ⇄ 12/77), 946, 1046 (4/73 ⇄ 9/77), 1246 (2/74 ⇄ 4/78) | 62/939-29 (2.006.209.436) | 9 dientes / <i>teeth</i> | | 62/933-18 25x25x10 (2.007.014.056) 1/78 ⇄ | Según el montaje <i>Depends fitting</i> |
| 353, 383 (4/73 ⇄ 2/75), 433, 533 (6/73 ⇄ 12/77), 453 | 62/939-35 (2.006.209.438) | 11 dientes / <i>teeth</i> | | 62/933-17 16x18x9 (2.007.014.057) <u>433, 533, 644,</u> <u>744, 745XL,</u> <u>844, 845XL,</u> <u>856XL</u> | 62/931-12 (2.004.004.112) |
| 353, 383, 453 (4/73 ⇄ 8/75), 433, 533 (6/73 ⇄ 12/77), 553 (4/73 ⇄ 1/74), 554 (2/74 ⇄ 2/75), 644, 744 (1/74 ⇄ 12/77), 654, 724, 824 (4/73 ⇄ 12/74), 834 (6/73 ⇄ 2/74), 844, 946, 1046 | | Fijación 3 tornillos <i>Fixed 3 bolts</i> | 62/940-19 (0.331.402.004) | | 62/931-17 (2.004.004.044) |
| 644, 744 (1/78 ⇄), 844 (1/78 ⇄ 4/80) | | | 62/940-28 (0.331.402.003) | | |
| 644, 744, 844 (1/78 ⇄), 1246 (5/78 ⇄) | 62/939-30 (2.006.209.492) | 9 dientes / <i>teeth</i> | | | |
| 844 (5/80 ⇄), 1246 (5/78 ⇄) | | Fijación 3 tornillos <i>Fixed 3 bolts</i> | 62/940-29 (0.331.402.002) | | |

Las referencias originales tienen un propósito identificativo.
Nuestras piezas no son originales.

Part numbers are quoted for reference purposes only.
Our parts and accessories are not original.

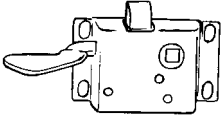
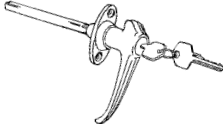

MANETAS PUERTAS
CAB DOOR LOCKS & HANDLES

| | | | |
|---|-----------------------------|----------------|---|
|  | 70/4170-32 (6066) | Izq./ LH | Series/ Series Cabina comfort 2000 Cab |
| | 70/4170-33 (6065) | Drcha./ RH | Series/ Series Cabina comfort 2000 Cab |
|  | 70/4170-18 (6734) | Maneta/ Handle | Series/ Series Cabina comfort 2000 Cab |

RETROVISOR / MIRROR

70/4172-27 240 x 150mm
(3399576R91)

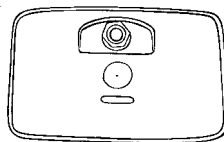

Series XL / XLA Series

Para más información ver la gama completa en la sección 1 del catálogo. / For further details, see the complete range in part 1 of the catalogue .



PINTURA / PAINT

**LA MEJOR
PINTURA**

LAQUE AMERICAINE

**THE BEST PAINT
ON THE MARKET**



64/LA.3011/L
64/LA.5044/L
64/LA.5044/SP
64/LA.2156009/L
64/LA.2156009/SP
64/LA.5042/L
64/LA.5042/SP
64/LA.8067/L
64/LA.8067/SP
64/LA.5032/L
64/LA.6014/L
64/LA.6014/SP
64/LA.5016/L
64/LA.5016/SP

Naranja / Orange - CASE
Rojo / Red - CASE
Rojo / Red - CASE
Negra semi-brillante / Semi gloss black
Negra semi-brillante/ Semi gloss black
Rojo / Red - IH
Rojo / Red - IH
Plata / Silver - IH
Plata / Silver - IH
Rojo / Red - MAXXUM CASE-IH
Gris / Grey beige - Mac Cormick
Gris / Grey beige - Mac Cormick
Rojo / Red - Mac Cormick
Rojo / Red - Mac Cormick

(1 litro/ liter)
(1 litro/ liter)
(Spray)
(1 litro/ liter)
(Spray)
(1 litro/ liter)
(Spray)
(1 litro/ liter)
(Spray)
(1 litro/ liter)
(1 litro/ liter)
(Spray)
(1 litro/ liter)
(Spray)



PINTURA DE CALIDAD A UN PRECIO ATRACTIVO
QUALITY PAINT AT AN ATTRACTIVE PRICE

64/3102-40 CASE-IH Rojo / Red
64/3102-16 CASE-IH Naranja / Orange

Las referencias originales tienen un propósito identificativo.
Nuestras piezas no son originales.

Part numbers are quoted for reference purposes only.
Our parts and accessories are not original.



AMORTIGUADORES PARA CABINA "DE LUXE" GAS STRUTS FOR "DE LUXE" CABS

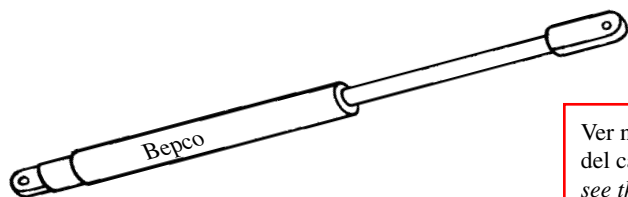

Ver nuestro gama completa en el fasciculo 1 del catalog general/ For further details, see the complete range in part 1 of the catalogue .



| Tractores Tractors | Parabrisas Windscreen | Puerta Door | Techo Roof | Ventana trasera Rear window | Capó Bonnet |
|--|--|--|--|--|---|
| 433, 533, 633, 733, 833 (Cabinas Kabines C.82 ""STD"", ""S3"" & ""Luxe"" Cabs) | 25/872-11 (1284622C2) 240mm | 25/872-11 (1284622C2) 240mm | | 25/870-9 (1284636C2) 240mm | |
| 533, 633, 733, 833 | | 25/872-22 (1332420C1) 501mm | | | |
| 644, 744, 844, 946, 955, 1046, 1055, 1246 (Cabina ""Comfort 2000"" Cab) | 25/872-12 (3232760R2) 403mm | | 25/871-8 (3221572R1) 250mm | 25/870-10 (3221531R1) 500mm | |
| 743, 745, 844S, 845, 955, 1055 | | | 25/871-9 (3399042R1) 243mm | 25/870-11 (3225465R2) 500mm | |
| 743, 745, 844, 845, 856, 955, 956, 1055, 1056, 1255, 1455, 3210, 3220, 3230, 4210, 4220, 4230, 4240 (Cabina XL Cab) | | 25/872-14 (3232937R1) 278mm | 25/871-11 (3399422R3) 224mm | 25/870-15 (3234163R1) 550mm WG.6 / WG.6 | |
| Serie XL Serie | | | | 25/870-36 (3148826R2) 498mm WG.134/AV Ø8 | |
| 5120 | | | | | 25/876-1 (1531489C1) 402mm |
| 5130, 5140, 5150 | | | 25/871-11 (3399422R3) 224mm | 25/870-31 (1971235C2) 474mm | 25/876-2 (1531490C1) 402mm |
| 7110E, 7120E, 7130, 7140, 7210, 7220, 7230, 7240, 7250 | | 25/872-21 (1280263C1) 326mm | | 25/870-32 (1343825C1) 304mm | |
| 9270, 9280, 9310, 9330, 9350, 9370, 9380, 9390 | | | | | |
| CS48, CS58, CS68, CS75 | 25/870-34 (199976066) 451mm | | | | |
| CS78, CS86, CS94, CS110, CS120, CS130, CS150 | | | | 25/870-34 (199976066) 451mm | |
| CX50, CX60, CX70, CX80, CX90, CX100, MX80C, MX90C, MX100C, MX100, MX110, MX120, MX135, MX150, MX170 | 25/870-33 (189447A2) 484mm | | | 25/870-33 (189447A2) 484mm | |
| MX180, MX200, MX220, MX240, MX270 | | 25/872-21 (1280263C1) 272mm | | | |

Las referencias originales tienen un propósito identificativo.
Nuestras piezas no son originales.

Part numbers are quoted for reference purposes only.
Our parts and accessories are not original.



ESCOBILLAS Y MOTORES DEL LIMPIA-PARABRISAS
WIPER MOTORS & BLADES

ESCOBILLAS
WIPER BLADES

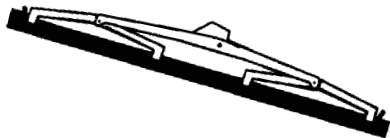

| | | |
|-----------------------------------|------------|---|
| 70/1987-9 (3113077R1) | 400/410 mm | 743, 745, 745S, 844S, 845 |
| 70/1987-20 (3234746R91) | 500/510 mm | 743XL, 745XL, 844XL, 845XL, 856XL, 955XL, 956XL, 1055XL, 1056XL |
| 70/1987-18 (3113942R1) | 450/460 mm | Serie Magnum serie |
| 70/1987-22 (10/3229) | 550/560 mm | Serie Maxxum serie |

Fijación descentrada / Offset fixing

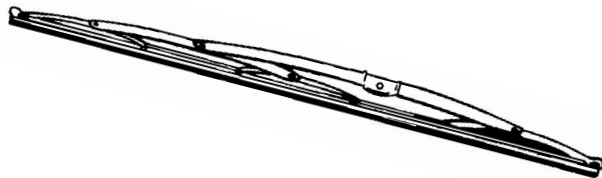

| | |
|-----------------------------------|-------------------------------------|
| 70/1987-25 (3401303R91) | Cabina XL Cab (Repl. SWF 105281) |
|-----------------------------------|-------------------------------------|

MOTORES DEL LIMPIA PARABRISAS
WIPER MOTOR

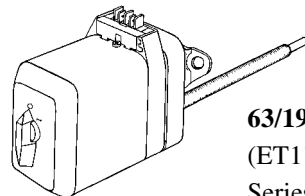

110°
12 volts

63/1980-5
(ET113/12)
Series 33 & 44 Series

Presión / Torque : 7 Newtons

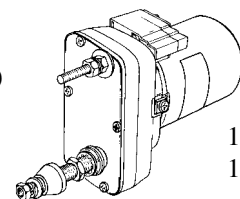

135°
12 volts

63/1980-4
(ET623045)

433, 533, 633, 733, 833, 933, 743, 745, 844, 856, 940, 956, 1056, 1594 (Combi-Cab)

CALEFACCIÓN DE CABINA
CAB HEATER

Cabina XL Cab



25/1988-1 - Motor
(1974779C1)

Ver nuestro gama completa en el fasciculo 1 del catálogo general
For further details, see the complete range in part 1 of the catalogue .



ASIENTO
SEATS

KAB//Seating

ASIENTO COMPLETO / COMPLETE SEAT

61/830-520
(6/856 KAB-AC)



- * Asiento neumático de excelente calidad con amortiguador de doble efecto
- * Regulable en altura
- * Con railes desplazable
- * Sujeción lumbar de 5 posiciones
- * Apoya-brazos regulables
- * Respaldo inclinable +66° / -72°
- * Opciones : Apoya cabezas
suspensión horizontal
Base pivocante

- * *Excellent quality pneumatic seat with twin action shock absorber*
- * *Height adjustment*
- * *Horizontal adjustment (sliderails)*
- * *Lumbar support adjustment, 5 positions*
- * *Armrest angle adjustment*
- * *Backrest angle adjustment +66° / -72°*
- * *Options : Headrest
Horizontal suspension
Swivel base*

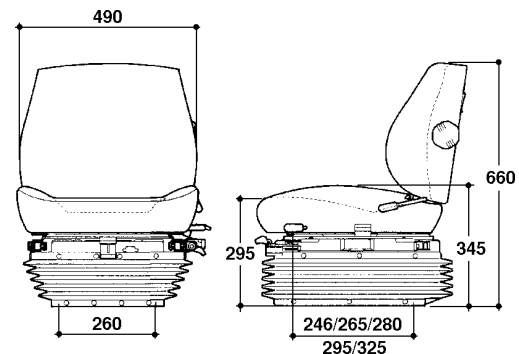

Ver nuestro gama completa en el fasciculo 1 del catalog general/ For further details, see the complete range in part 1 of the catalogue .

**GOMA PARA CRISTALES DE CABINA
GLAZING RUBBER AND DRAFT EXCLUDERS**

| Ref. Ref. | Secciones (Goma negra) Sections (Black rubber) | | | | Secciones (Negra) Sections (Black) | | | | | |
|------------------------------|---|--------------------------------|--------------------------------|--|---------------------------------------|-------------------------|------------------------|------------------------|------------------------|------------------------|
| | | | | | | | | | | |
| | 70/4110-9 (13/1200) (A) | 70/4110-10 (13/1206) (B) | 70/4110-11 (13/1207) (C) | 70/4111-4 (13/1201) | 70/4110-12 (13/1208) | 70/4110-13 (13/1209) | 70/4112-2 (13/1202) | 70/4112-3 (13/1203) | 70/4112-4 (13/1204) | 70/4112-5 (13/1205) |
| Tamaño cristal Glass size | 6,0mm | 4,7mm | 4,7mm | Filtro para Filler strip for A, B, C | 5,0mm | 4,0mm | | 2-5mm | 5-6mm | 6mm |
| Panel Panel | 1,2/1,6mm | 1,2/1,6mm | 2,6/3,2mm | | 2mm | 2mm | | | | |

Se vende en metros / Verkocht per meter

Las referencias originales tienen un propósito identificativo.
Nuestras piezas no son originales.

Part numbers are quoted for reference purposes only.
Our parts and accessories are not original.



**CRISTAL DE CABINA
CAB GLASS**

CABINA XL / XL CAB

745, 844, 845, 856, 955, 956, 1055, 1056, 1255, 1455

Todos los cristales son tintados
Tinted glass

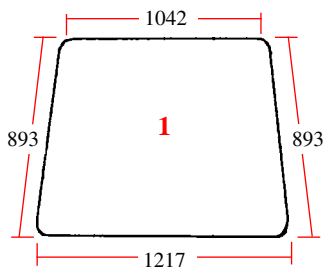
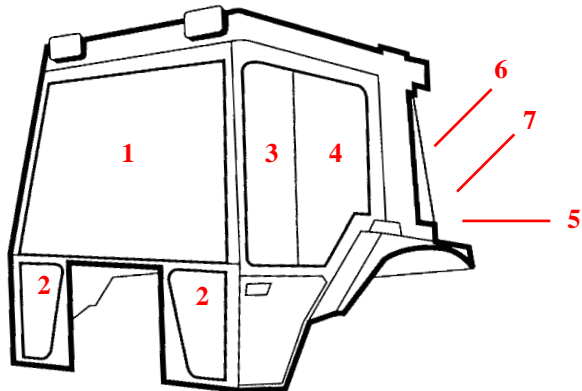

25/4000-36
(D.7010, 3233045R1)
Parabrisas
Windscreen

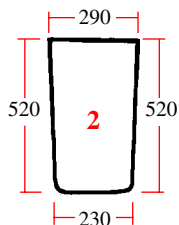

25/4012-23
(D.7011, 3233036R1)
Avant (drcha & Izq)
Front (RH & LH)

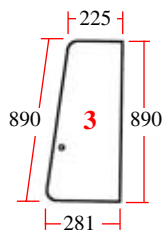

25/4026-2
(D.7013, 3233053R1)
Puerta (deslizante)
Door

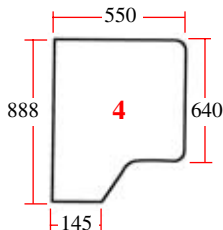

25/4027-2
(D.7014, 3233051R1)
Puerta (fijo)
Door

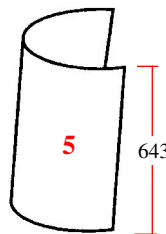

25/4086-1
(D.7016, 3233041R1)
Trasero drcha. (angulo)
Rear RH (corner)

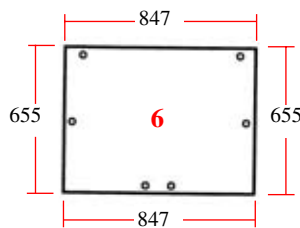

25/4085-1
(D.7015, 3233040R1)
Trasero gauche (angulo)
Rear LH (corner)

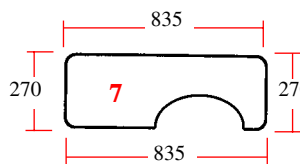

25/4073-15
(D.7019, 1500941C1)
Trasero (inferior)
Rear (lower)

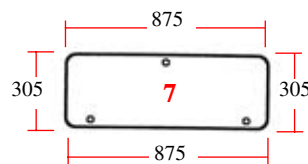

25/4073-14
(D.7018, 3233032R1)
Trasero (inferior)
Rear (lower)

CABINA "TIMMERMAN" CAB

645, 745, 845, 955, 1055, 1255

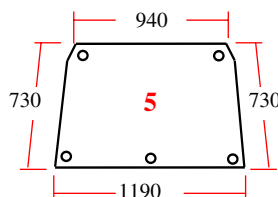

25/4072-25
(D.7012, 3226351R3)
Trasero (superior)
Rear (upper)

Las referencias originales tienen un propósito identificativo.
Nuestras piezas no son originales.

Part numbers are quoted for reference purposes only.
Our parts and accessories are not original.



CRISTAL DE CABINA
CAB GLASS

CABINA XLN / XLN CAB

743, 745, 844, 845

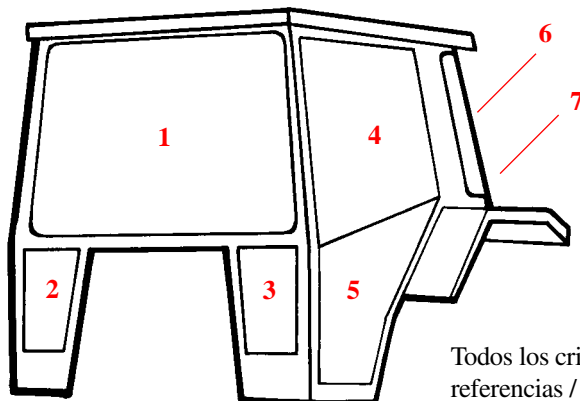

Todos los cristales son tintados excepto las referencias / *Tinted glass except*
25/4012-29 y/ & 25/4073-21

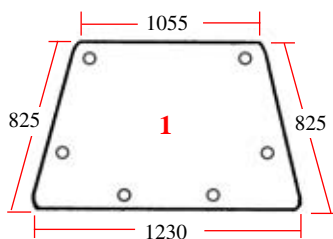

25/4000-45
(D7060, 1535093C2)
Parabrisas
Windscreen

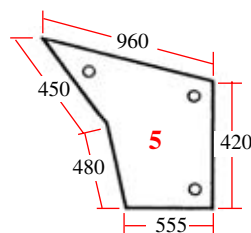

25/4021-22
(D7063, 1535114C1)
Puerta (inferior)
Doors (lower)

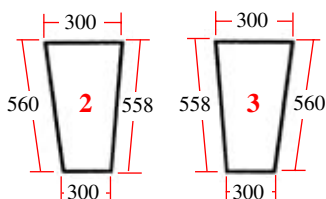

25/4012-29
(D7061, 1535088C1)
Frontal inferior (drcha. y izq.)
Front (RH & LH)

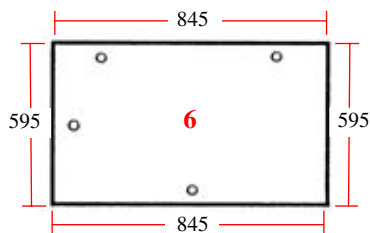

25/4072-32
(D7064, 1535079C1)
Trasero (superior)
Rear (upper)

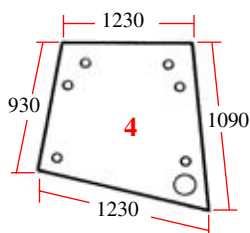

25/4022-22
(D7062, 1535113C1)
Puerta (superior)
Doors (upper)

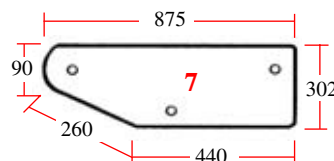

25/4073-21
(D7065, 1535071C1)
Trasero (inferior)
Rear (lower)

Las referencias originales tienen un propósito identificativo.
Nuestras piezas no son originales.

*Part numbers are quoted for reference purposes only.
Our parts and accessories are not original.*



**CRISTAL DE CABINA
CAB GLASS**

TRACTORES SERIES MAXXUM / TRACTORS MAXXUM SERIES

5120, 5130, 5140, 5140 (SYNCHRO), 5150

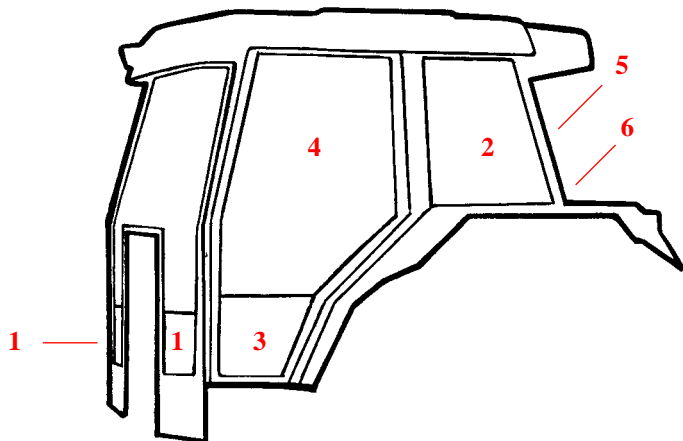

25/4038-7

(D7074, 1330930C1)
⇨ JJE.1020700
Puerta drcha., 7 agujeros
Door RH, 7 holes

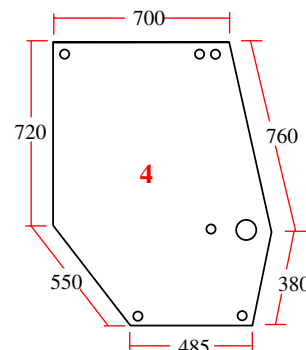

25/4039-7

(D7076, 1330931C1)
⇨ JJE.1020700
Puerta izq., 7 agujeros
Door LH, 7 holes

25/4011-8
(D7072, 1330877C1)
Frontal delantero (inferior drcha.)
Front RH (lower)

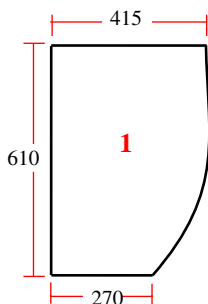

25/4011-9
(D7073, 1330876C1)
Frontal delantero (inferior izq.)
Front LH (lower)

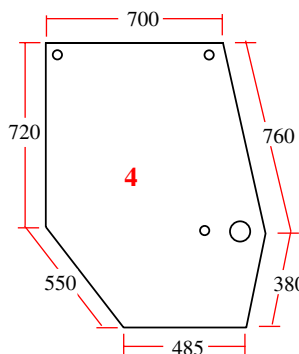

25/4038-8
(D7075, 1546817C2)
JJE.1020700 ⇨
Puerta drcha., 4 agujeros
Door RH, 4 holes

25/4039-8
(D7077, 1546818C2)
JJE.1020700 ⇨
Puerta izq., 4 agujeros
Door LH, 4 holes

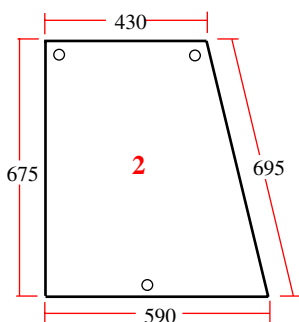

25/4047-34
(D7078, 1330903C1)
Lateral drcha., 3 agujeros
Side window RH,
3 holes

25/4072-40
(D7081, 1330904C1)
⇨ JJE.1030000
Trasero (superior)
Rear (upper)

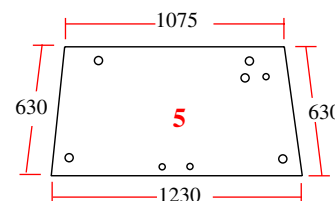

25/4047-35
(D7079, 1330902C1)
Lateral izq., 3 agujeros
Side window LH,
3 holes

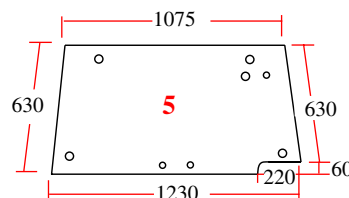

25/4072-41
(D7080, 127442A1)
JJE.1030001 ⇨
Trasero (superior) con recorte
Rear (upper) with cut out

25/4025-4
(D7083, 1999626C2)
Inferior puerta (drcha.), 2 agujeros
Door RH (lower), 2 holes

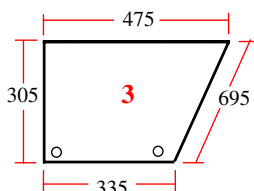

25/4029-4
(D7084, 1999625C2)
Inferior puerta (izq.), 2 agujeros
Door LH (lower), 2 holes

25/4073-36
(D7082, 1981934C1)
Trasero (inferior)
Rear (lower)

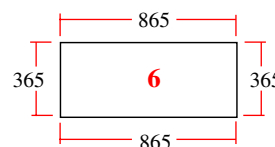

Las referencias originales tienen un propósito identificativo.
Nuestras piezas no son originales.

Part numbers are quoted for reference purposes only.
Our parts and accessories are not original.





INDEX

| | | | |
|---|-------|---|-------|
| Alternadores | 32 | <i>Alternators</i> | 32 |
| Amortiguadores | 35 | <i>Brakes</i> | 21 |
| Asiento | 35 | <i>By-pass hoses</i> | 11 |
| Bombas de aceite | 9 | <i>Cab door locks and handles</i> | 34 |
| Bombas de agua y juego de reparación | 11 | <i>Cab glass</i> | 37-41 |
| Bombas gas-oil | 10 | <i>Clutch assemblies and plates</i> | 18-20 |
| Bombas hidráulica | 28 | <i>Cooling hoses</i> | 12 |
| Cables de cuentahoras | 17 | <i>Crankshafts & related parts</i> | 3 |
| Caja niveladora | 30 | <i>Cross references</i> | 42-57 |
| Calentadores | 10 | <i>Cylinder head parts</i> | 7 |
| Cigüñales y piezas relacionadas | 3 | <i>Dynamos</i> | 32 |
| Cilindros principal y receptor | 20-21 | <i>Drive cables</i> | 17 |
| Correas ventilador | 10 | <i>Engine gasket sets</i> | 8 |
| Cristal de cabina | 37-41 | <i>Fan belts</i> | 10 |
| Crucetas eje delantero | 26 | <i>Filters</i> | 13-14 |
| Eje delantero | 22-25 | <i>Front axle shaft</i> | 28 |
| Eje trasero | 29 | <i>Front axle parts</i> | 22-26 |
| Embragues | 18-20 | <i>Fuel pumps</i> | 10 |
| Equipo de cilindro | 6 | <i>Gas struts</i> | 35 |
| Escobillas y motores para limpia-parabrisas | 36 | <i>Glazing rubber</i> | 36 |
| Estabilizador | 31 | <i>Heater plugs</i> | 10 |
| Faros de trabajo | 16 | <i>Hydraulic pumps</i> | 28 |
| Filtros | 13-14 | <i>Injector nozzles</i> | 9 |
| Freno | 21 | <i>Instruments (miscellaneous)</i> | 8 |
| Generadores | 32 | <i>Items (miscellaneous)</i> | 17 |
| Goma para cristales de cabina | 36 | <i>Levelling box assembly</i> | 30 |
| Instrumentaos diversos | 17 | <i>Lighting</i> | 16 |
| Interruptor | 17 | <i>Master and slave cilindres</i> | 20-21 |
| Juego de motor completo | 6 | <i>Mirrors</i> | 35 |
| Juntas de motor | 8 | <i>Mufflers (vertical)</i> | 15 |
| Lista de referencias cruzadas | 42-57 | <i>Oil pumps</i> | 9 |
| Luces | 16 | <i>Overhaul kits</i> | 6 |
| Manetas de la puerta | 34 | <i>Paint</i> | 34 |
| Manguitos de bomba de agua | 11 | <i>Pistons, ring sets and liners</i> | 6 |
| Manguitos radiador | 12 | <i>Radiator caps</i> | 11 |
| Manocontactos | 8 | <i>Rear axle parts</i> | 29 |
| Motores de arranque | 33 | <i>Seats</i> | 35 |
| Pintura | 34 | <i>Spare parts for OEM linkage levelling rods</i> | 30 |
| Repuestos para horquilla original | 30 | <i>Stabilisers and components</i> | 31 |
| Repuestos para válvula y culatas | 7 | <i>Starter motors</i> | 33 |
| Retrovisores | 35 | <i>Starter switch</i> | 17 |
| Rótula y acoples de dirección | 27 | <i>Studs and screws (rear wheel)</i> | 26 |
| Sensor de temperatura | 8 | <i>Switches</i> | 8 |
| Silenciosos (Vertical) | 15 | <i>Temperature sender</i> | 8 |
| Tapón radiador | 11 | <i>Thermostats</i> | 11 |
| Termostatos | 11 | <i>Tie rods and sockets</i> | 27 |
| Toberas | 9 | <i>Tractors and engine application chart</i> | 2 |
| Tornillos y tuercas (Llanta traseras) | 26 | <i>Water pumps and repair kits</i> | 11 |
| Tractores y motores, tabla de aplicaciones | 2 | <i>Wiper motors and blades</i> | 36 |
| Transmisión completa | 28 | <i>Work lights</i> | 16 |

Las referencias originales tienen un propósito identificativo.
Nuestras piezas no son originales.

Part numbers are quoted for reference purposes only.
Our parts and accessories are not original.



TRACTORES Y MOTORES, TABLA DE APLICACIONES
TRACTORS AND ENGINE APPLICATION CHART
CASE-IH EUROPE
CIH-1 / CIH-57

| Tractores Tractors | Motor Engine | Tractores Tractors | Motor Engine | Tractores Tractors | Motor Engine |
|---|--------------------------|--------------------------|-------------------------|----------------------------|-------------------------------------|
| D.217, D.217S, D.219 | DD.74 (2 cil./cyl.) | 856XL | DT.239 (4 cil./cyl.) | MAXXUM 5140 | 6T-590 (6 cil./cyl.) |
| D.324, D.326 | DD.111 (3 cil./cyl.) | 824, 844 | D.246 (4 cil./cyl.) | MAXXUM 5150 | 6T-690 (6 cil./cyl.) |
| 323 | DU.111 (3 cil./cyl.) | 844S, 845S, 845XL | D.268 (4 cil./cyl.) | MAGNUM 7110, 7120 | 6T-830 (6 cil./cyl.) |
| D.436, DTD.5 | DD.148 (4 cil./cyl.) | 756, 946, 955 | D.310 (6 cil./cyl.) | MAGNUM 7130 | 6T-830 / 6CT-830 (6 cil./cyl.) |
| D.439 | DU.148D (4 cil./cyl.) | 956, 1046, 1055, 1056 | D.358 (6 cil./cyl.) | MAGNUM 7140 | 6TA-830 / 6CTA-830 (6 cil./cyl.) |
| 353, 383, 423, 433, 440, 453, 533, 540 | D.155 (3 cil./cyl.) | 1246, 1255 (+ XL) | DT.358 (6 cil./cyl.) | | |
| 523, 553, 633, 640 | D.179 (3 cil./cyl.) | 1455 (+ XL) | DT.402 (6 cil./cyl.) | MAGNUM 7210, 7220, 7230 | 6T-830 (6 cil./cyl.) |
| 554, 624, 644, 645, 654, 733, 740 | D.206 (4 cil./cyl.) | MAXXUM 5120 | 4T-390 (4 cil./cyl.) | MAGNUM 7240 | 6TI-830 (6 cil./cyl.) |
| 724, 743, 744, 745, 833, 840, 846 | D.239 (4 cil./cyl.) | MAXXUM 5130 | 6-590 (6 cil./cyl.) | MAGNUM 7250 | 6TIR-830 (6 cil./cyl.) |

CASE-IH ENGLAND
CIHE-1 / CIHE-48

| Tractores Tractors | Motor Engine | Tractores Tractors | Motor Engine | Tractores Tractors | Motor Engine |
|----------------------------|---------------------------|-----------------------------|--------------------------|----------------------------------|--------------------------|
| 275, 276, 354 | BD.144 (4 cil. / cyl.) | 454, 484, 485, 495, 3220 | D.179 (3 cil. / cyl.) | 574, 674, 684, 685, 695, 4210 | D.239 (4 cil. / cyl.) |
| 374, 384, 414, 434, 444 | BD.154 (4 cil. / cyl.) | 474, 584, 585, 595, 3230 | D.206 (4 cil. / cyl.) | 784, 785, 795, 4220 | D.246 (4 cil. / cyl.) |
| 385, 395, 3210 | D.155 (3 cil. / cyl.) | 475 | Perkins A4.212 | 884, 885, 895, 4230 | D.268 (4 cil. / cyl.) |

Las referencias originales tienen un propósito identificativo.
 Nuestras piezas no son originales.

Part numbers are quoted for reference purposes only.
 Our parts and accessories are not original.



"THE RELIABLE SERVICE"



CIGÜEÑALES Y PIEZAS RELACIONADAS
CRANKSHAFTS & RELATED PARTS

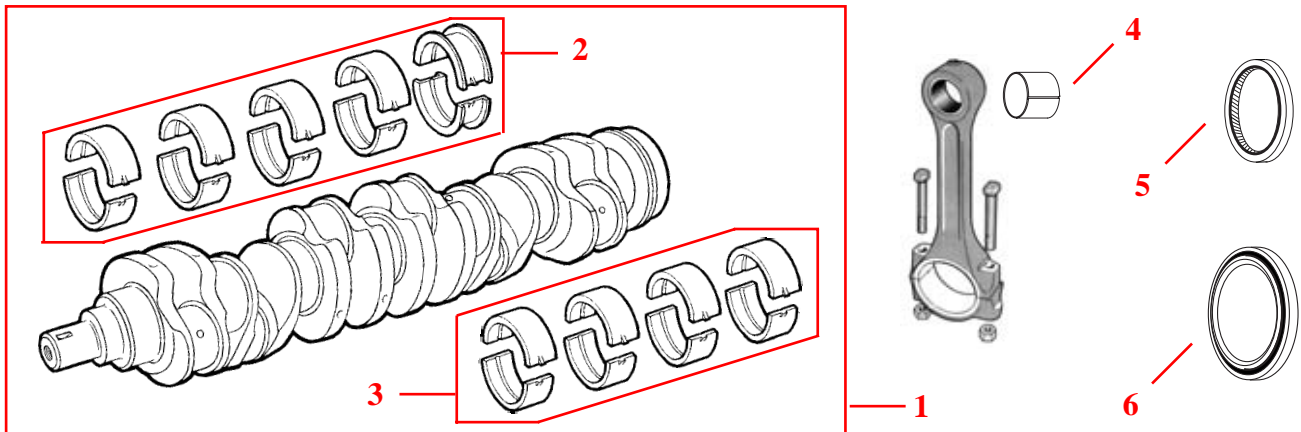

| Fig. | 1 | 2 | 3 | 4 | 5 | 6 | |
|---|-----------------|--|--|--|--------------------------------|---------------------------------|---------------------------------|
| Tractores Tractors | Motor Engine | Juego cigüeñal Crankshaft kit | Cojinete de bancada Main bearing | Cojinete de biela Con. rod. bearing | Buje biela Small end bush | Retén delantero Front seal | Retén trasero Rear seal |
| 275, 276, 354 (4 cil./ cyl.) | BD.144 | 25/1-54 (3110995R91) | 25/2-21 (708912R91) | 25/3-21 (3070546R91) (4 x 3070536R11) | 25/28-12 (3043611R1) | 25/11-16 (3108650R91) | 25/13-14 (3072092R91) |
| 374, 384, 414, 434, 444 (4 cil./ cyl.) | BD.154 | | | | | | |
| 385, 395, 3210 (+XL) (3 ccil./ cyl.) | D.155 | | 25/2-23 (1 x 3055129R21 3 x 3055130R21) | 25/3-23 (3 x 3055351R91) | | | |
| 454, 484, 485, 495, 3220 (+XL) (3 cil./ cyl.) | D.179 | | | | | | |
| 474, 584, 585, 595, 3230 (+XL) (4 cil./ cyl.) | D.206 | 25/1-55 (3132968R93, 1329196C1) | 25/2-24 (1 x 3055129R21 4 x 3055130R21) | 25/3-24 (4 x 3055351R91) | 25/28-14 (3132018R2) | 25/11-18 (3228401R91) | 25/13-16 (3138701R91) |
| 475 | A4.212 | 25/1-3 (3118169R91) | 25/2-22 (3118150R1) (A) | 25/3-22 (3118135R1) | | | |
| 574, 674, 684, 685, 695, 4210 (+XL) (4 cil./ cyl.) | D.239 | 25/1-56 (3144626R92) | 25/2-24 (1 x 3055129R21 4 x 3055130R21) | 25/3-24 (4 x 3055351R91) | 25/28-14 (3132018R2) | 25/11-18 (3228401R91) | 25/13-16 (3138701R91) |
| 784, 785, 795, 4220 (+XL) (4 cil./ cyl.) 84-hydro, 85-hydro | D.246 | | | | | | |
| 884, 885, 895, 4230 (+XL) (4 cil./ cyl.) | D.268 | | | | | | |

(A) : Arandelas laterales axial están disponibles en : / Thrust washer sets are available
A standard / Standard size : **25/6-16** (B616) = 2x **25/4-16** (796189R1) + 2x **25/5-16** (796190R1)
A sobremedida desde +0,007" / .007" oversize : **25/6-17** (B617) = 2x **25/4-17** (796202R1) + 2x **25/5-17** (796203R1)

Cojinetes de bancada y de biela disponibles en las siguientes sobremedidas 0,010"- 0,020"- 0,030". Consultenos.
Main and con-rod bearings are available in 0,010"- 0,020"- 0,030" oversizes. Please ask.

Junta para tapa cigüeñal / Crankshaft seals

Mot. D.155, 206, 310, 179,
239, 246, 268 Engine

25/17-11
(3055215R3)



Junta
Gasket

Juego 4 piezas con retén delantero
Kit of 4 parts incl. front seal

25/11-19
(3228133R93)

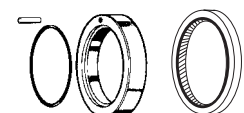

Las referencias originales tienen un propósito identificativo.
Nuestras piezas no son originales.

Part numbers are quoted for reference purposes only.
Our parts and accessories are not original.



**EQUIPO DE CILINDRO
PISTONS, RING SETS & LINERS**

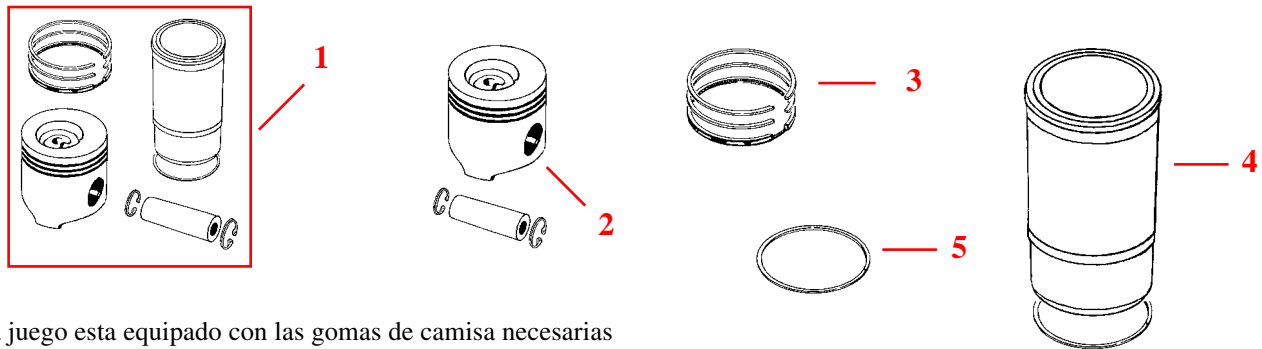

Cada juego esta equipado con las gomas de camisa necesarias
Each kit set is supplied with suitable sealing rings

| Fig. | | 1 | 2 | 3 | 4 | 5 | |
|--|-----------------|----------------------|--|--|---|--------------------------------|--|
| Tractores Tractors | Motor Engine | Diametro Diameter | Juego Kit set | Pistón Piston | Juego de segmentos Ring set | Camisa Liner | Junta tórica Sealing ring |
| 275, 276, 354 (4 cil./ cyl.) | BD.144 | 85,7mm | 25/31-42 (751604R92) | 25/33-42 (3048523R1) | 25/34-42 (3114775R91) | 25/35-42 (704092R1) | 25/38-42 (704100R1) |
| 414, 434, 444, 374, 384 (4 cil./ cyl.) | BD.154 | 88,9mm | 25/31-44 (3044479R94) | 25/33-44 (3044486R3) | 25/34-44 (3114778R91) | 25/35-44 (3044481R3) | |
| 385, 395, 3210 (+ XL) (3 cil./ cyl.) | D.155 | 98,4mm | 25/31-62 (3218758R95) No/ Not AL FIN | 25/33-62 (B.3362) No/ Not AL FIN | 25/34-65 (3139594R91) AL FIN 3 segm./ rings | 25/35-62 (3139587R3) | 25/38-62 (3228344R1) Ø 5,0mm 25/38-63 (3228348R1) Ø 4,7mm |
| 474, 584, 585, 595, 3230 (+ XL) (4 cil./ cyl.) | D.206 | | 25/31-64 (3139586R95) AL FIN (A) | 25/33-64 (B.3364) AL FIN | 25/34-62 (3218416R92) 3 segm./ rings | | |
| 454, 484, 485, 495, 3220 (+ XL) (3 cil./ cyl.) | D.179 | | 25/31-63 (3218759R95) No/ Not AL FIN | 25/33-63 (B.3363) No/ Not AL FIN | 25/34-60 (3059262R92) 4 segm./ rings AL FIN | 25/35-63 (3139592R4) | |
| 574, 674, 684, 685, 695, 4210 (+ XL) (4 cil./ cyl.) | D.239 | | 25/31-65 (3139591R96) AL FIN (B) | 25/33-65 (B.3365) AL FIN | 1. cónico <i>1st wedged ring</i> | | |
| 475 | A4.212 | | 25/31-61 (B3161) | 25/33-61 (B.3361) | 25/34-61 (3118131R1) | 25/35-61 (796227R1) | |
| 784, 785, 795, 4220 (+ XL) 84-hydro, 85-hydro (4 cil./ cyl.) | D.246 | 100mm | 25/31-66 (3218668R94) | 25/33-66 (B.3366) | 25/34-66 (3218669R91) | 25/35-66 (3144682R3) | |
| 884, 885, 895, 4230 (+ XL) (4 cil./ cyl.) | D.268 | | 25/31-67 (3218461R95) AL FIN | 25/33-67 (B.3367) AL FIN | 25/34-67 (3144977R91) | | 25/38-63 (3228348R1) Ø 4,7mm |

(A) Carrera / Stroke : 111,1 mm
(B) Carrera / Stroke : 128,5 mm

Las referencias originales tienen un propósito identificativo.
Nuestras piezas no son originales.

Part numbers are quoted for reference purposes only.
Our parts and accessories are not original.



**PISTONES
PISTONS**

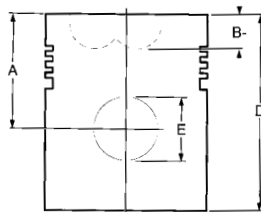
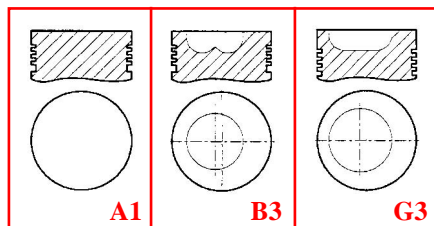

- A : Altura de compresión (mm)
Compression height (mm)
- B : Profundidad camara de combustión (mm)
Combustion bowl depth (mm)
- D : Longitud total (mm)
Overall length (mm)
- E : Diámetro bulón (mm)
Gudgeon pin diameter (mm)

| Referencia References | Motores Engines | Ø pistón Bore dia. | Tipo Type | Número de aros N° of Rings | Alfin Al-fin | A | B | D | E |
|--------------------------|-----------------------|-----------------------|--------------|-------------------------------|-----------------|-------|-------|--------|-------|
| 25/33-42 | BD.144 | 85.72 | A1 | 5 | | 50.95 | | 98.98 | 28.00 |
| 25/33-44 | BD.154 | 88.90 | | | | | 50.90 | | |
| 25/33-62 | D.155, D.206 D.310 | 98.42 | B3 | 3 | | 67.00 | 19.90 | 101.50 | 36.00 |
| 25/33-64 | | | | | Sí Yes | | | 107.00 | |
| 25/33-63 | D.179, D.239 D.358 | 98.42 | B3 | 3 | | 67.00 | 24.00 | 101.50 | 36.00 |
| 25/33-65 | | | | | Sí Yes | | | 107.00 | |
| 25/33-61 | A4.212 | 98.48 | G3 | | | 76.53 | 19.57 | 116.13 | 34.92 |
| 25/33-66 | D.246 | 100.00 | B3 | | | 67.00 | 22.30 | 107.00 | 36.00 |
| 25/33-67 | D.268 | 100.00 | | Sí Yes | | | 24.00 | | |

**CAMISAS
LINERS**

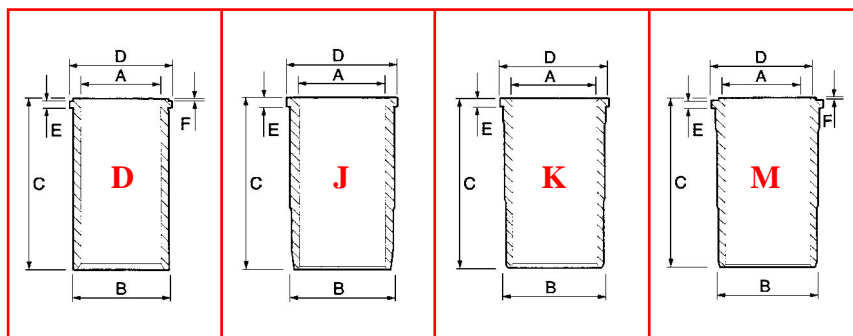

- A : Diámetro pistón (mm)
Nominal bore diameter (mm)
- B : Diámetro exterior (mm)
Outside diameter (mm)
- C : Longitud total (mm)
Overall length (mm)
- D : Diámetro pestaña (mm)
Flange diameter (mm)
- E : Anchura pestaña (mm)
Flange width (mm)
- F : Altura cortafuego (mm)
Fire lip height (mm)











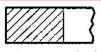

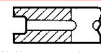
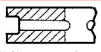
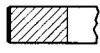
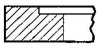
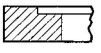
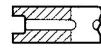
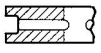
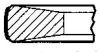

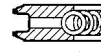
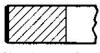
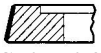



| Referencia References | Tipo Type | A | B | C | D | E | F |
|--------------------------|--------------|-------|--------|--------|--------|------|------|
| 25/35-42 | J | 85.72 | 93.64 | 179.39 | 101.70 | 5.82 | |
| 35/35-44 | K | 88.90 | 93.65 | 185.73 | | | |
| 35/35-61 | D | 98.48 | 103.19 | 227.28 | 106.45 | 3.71 | 1.04 |
| 25/35-62 | M | 98.42 | 110.75 | 201.10 | 119.00 | 7.70 | 1.10 |
| 35/35-63 | | | | 216.10 | | | |

Las referencias originales tienen un propósito identificativo.
Nuestras piezas no son originales.

Part numbers are quoted for reference purposes only.
Our parts and accessories are not original.



JUEGOS DE SEGMENTOS
RING SETS

| Referencia References | Motores Engines | Ø pistón Bore dia. | | | | | |
|--------------------------|-------------------------------|-----------------------|--|--|--|--|---|
| 25/34-42 | BD.144 | 85.72mm |  CP2 2.38 |  P1 2.38 |  P1 3.17 |  SS 4.76 |  SS 4.76 |
| 25/34-44 | BD.154 | 88.90mm |  CP1 2.38 |  P2 2.38 |  P2 2.38 |  SS 4.76 |  SS 4.76 |
| 25/34-60 | | |  MK1 3.00 |  N1 3.17 |  P1 3.17 |  BEH 4.76 | |
| 25/34-62 | D.155, D.179, D.239, D.206 | 98.42mm |  CP1 3.17 |  CT2 2.38 |  CBEH 4.76 | | |
| 25/34-65 | | |  CK1 3.00 |  CT2 2.38 |  CBEH 4.76 | | |
| 25/34-61 | 4.212 | 98.48mm |  CP1 2.38 |  CP2 2.38 |  CBEH 4.76 | | |
| 25/34-66 | D.246 | |  CP1 3.17 |  CT2 2.38 |  CBEH 4.76 | | |
| 25/34-67 | D.268 | 100.00mm |  CK1 3.00 |  CT2 2.38 |  CBEH 4.76 | | |

- BEH : Rebajado con muelle helicoidal / *Bevelled edge with helical coil spring*
- CBEH : Cromado y rebajado con muelle helicoidal / *Chrome plated bevelled edge with helical coil spring*
- CP1 : Rectangular cromado / *Chrome plated parallel faced*
- CP2 : Rectangular cromado con escalón interior superior / *Chrome plated parallel faced internally stepped top*
- CK1 : Trapezoidal dos caras (Cromado exterior) / *Chrome plated keystone*
- CT2 : Periferia cónica cromado con escalón interior superior / *Chrome plated taper faced internally stepped top*
- MK1 : Trapezoidal ambos lados con recubrimiento de molibdeno en cara exterior / *Molybdenum coated keystone*
- N1 : Tipo "Napier" o "Pico de águila" / *Napier - externally stepped bottom with single hook*
- P1 : Rectangular / *Parallel faced plain*
- P2 : Rectangular con escalón interior superior / *Parallel faced internally stepped top*
- SS : Normal / *Standard slotted*

JUEGO DE MOTOR COMPLETO
OVERHAUL KITS

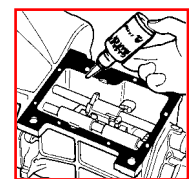
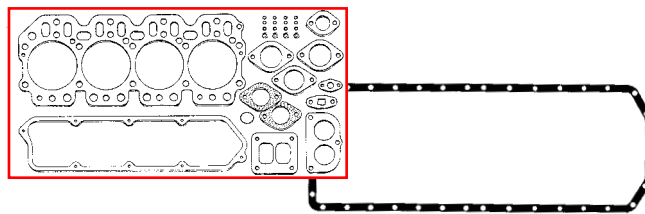
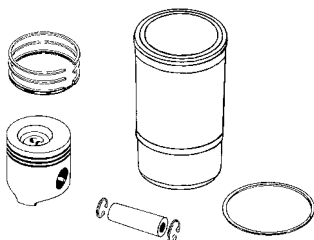

Se incluye : Juego de retenes, juego de juntas superior, junta del cárter y una lata de "Formajoint".
Included : kit sets with suitable sealing rings, top gasket set, sump gasket, one "Formajoint" can.

| Tractores Tractors | Motor Engine | Ø pistón Bore | Ø eje Pin Ø | Ref. n° Order N° | OEM |
|-------------------------------|-----------------|------------------|----------------|---------------------|----------|
| 385, 395, 3210 | D.155 | 98.42mm | 36.00mm | 25/30-120 | 25/586K3 |
| 454, 484, 485, 495, 3220 | D.179 | | | 25/30-123 | 25/591K3 |
| 474, 584, 585, 595, 3230 | D.206 | | | 25/30-121 | 25/586K4 |
| 574, 674, 684, 685, 695, 4210 | D.239 | | | 25/30-124 | 25/591K4 |
| 784, 785, 795, 4220 | D.246 | 100.00mm | | 25/30-128 | 25/668K4 |

Las referencias originales tienen un propósito identificativo.
Nuestras piezas no son originales.

Part numbers are quoted for reference purposes only.
Our parts and accessories are not original.



**REPUESTOS PARA VÁLVULAS Y CULATAS
CYLINDER HEAD PARTS**

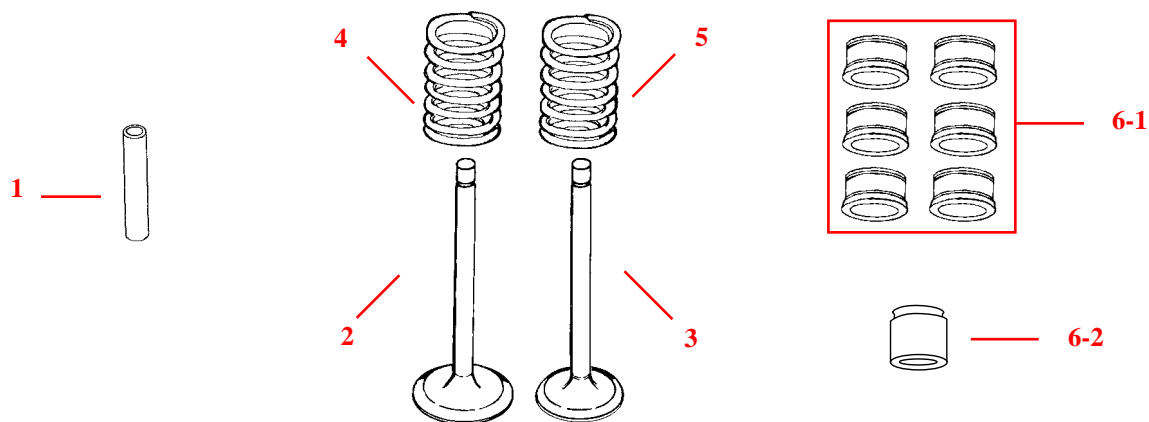

| Fig. | 1 | | 2 | | 3 | | 4 | | 5 | | 6 | |
|--|--------------------------------|--------------------------------|--------------------------------------|---------------------------------------|--------------------------------|--------------------------------|-----------------|---------------|---------------|---------------|--|--|
| Tractores Tractors | Guía / Guide | | Válvula / Valve | | | | Muelle / Spring | | | | Retén Seal | |
| | Adms. Inlet | Escape Exhaust | Adms. Inlet | Escape Exhaust | Int. Inner | Ext. Outer | Int. Inner | Ext. Outer | Int. Inner | Ext. Outer | | |
| 275, 276, 354 | 25/41-12 (704455R1) | 25/41-13 (704456R2) | 25/42-21 (3040361R1) | 25/43-21 (3043825R1) | 25/45-12 (710347R2) | | | | | | | |
| 374, 384, 414, 434, 444 | 25/41-14 (3044492R1) | 25/41-15 (3044493R2) | | | 25/44-13 (3044239R1) | 25/45-13 (3044240R1) | | | | | | |
| 385, 395, 454, 484, 485, 495, 474, 584, 585, 595, 574, 674, 684, 685, 695, 784, 785, 795, 884, 885, 895, 3210, 3230, 4210, 4220, 4230 (+XL) | 25/41-16 (3055022R2) | | 25/42-23 (3055055R2) | 25/43-23 (3055056R2) | 25/45-15 (3055060R1) | | | | | | 25/47-6 (3218399R91) 6-1 | |
| 475 | | | 25/42-22 (795730R1) (A) | 25/43-22 (3118132R1) (A) | 25/44-14 (3118134R1) | 25/45-14 (3118133R1) | | | | | 25/47-5 (3118179R1) 6-2 | |

(A) Las valvulas de admisión y escape podemos suministrarlas con las siguientes sobremedidas 0.003", 0.015" y 0.030". Para sus pedidos indicar A, B o C respectivamente. Consultar lista de referencias originales.
Inlet and Exhaust Valves are stocked in .003", .015" and .030" oversize. When ordering please suffix Bepco part number A, B or C respectively. See Cross-Reference List for equivalent Case-IH part numbers.

Las referencias originales tienen un propósito identificativo.
Nuestras piezas no son originales.

Part numbers are quoted for reference purposes only.
Our parts and accessories are not original.



**JUNTAS DE MOTOR
ENGINE GASKET SETS**

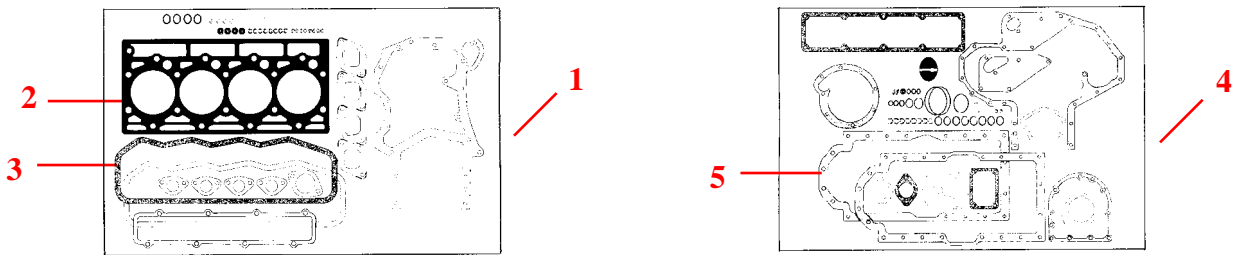

Los retenes delanteros y traseros no están incluidos.

Front and rear seals are not included

| Fig. | 1 | 2 | 3 | 4 | 5 |
|--|--|----------------------------------|---|---|--------------------------------|
| Tractores Tractors | Juego de juntas superior Top gasket set | Junta culata Cyl. head gasket | Junta balancines Rocker cover gasket | Juego de juntas inferior Bottom gasket set | Junta carter Sump gasket |
| 275, 276, 354, 374, 384 414, 434, 444 | 25/71-33 (706105R93) (A) | 25/73-33 (703883R7) | 25/74-25 (3069767R1) | 25/72-33 (B.1036) (A) | |
| 385, 395, 454, 484, 485, 495, 3210, 3220 (+XL) | 25/71-48 (3136798R99) | 25/73-48 (3228361R2) | 25/74-27 (3138641R1) | 25/72-48 (3136802R99) | 25/75-48 (3055160R3) |
| 474, 584, 585, 595, 574, 674, 684, 685, 695, 784, 785, 795, 884, 885, 895, 3230, 4210, 4220, 4230 (+XL) | 25/71-49 (3136799R99) | 25/73-49 (3228362R2) | 25/74-28 (3138642R2) | 25/72-49 (1967011C1) | 25/75-49 (3055161R3) |
| 475 | 25/71-47 (3118124R91) | 25/73-47 (3118173R1) | 25/74-26 (3118186R1) | 25/72-47 (3120516R91) | |

(A) : Juego juntas completo con ref. **25/70-33** (3041249R92). Contiene kit **25/71-33** y otro **25/72-33**

(A) : Complete Overhaul Set is available as **25/70-33** (3041249R92). It contains 1 each of **25/71-33** and **25/72-33**

MANOCONTACTOS / SWITCHES

| | | | |
|---|-----|---|--|
| 25/186-6 (91450C1, 376855R92) | (1) | Presión de aceite / Oil pressure 275 ⇄ 995 (+XL), 3210 ⇄ 3230, 4210 ⇄ 4240 | |
| 25/186-1 | (1) | Presión de aceite / Oil pressure 475 | |
| 25/187-4 (92161C2) | (2) | Caja de cambios y freno de mano / Gearbox and hand brake 385 ⇄ 895 (+XL) | |
| 25/187-5 (99990C1) | (3) | Caja de cambios (con cables) / Gearbox (with wire) 385 ⇄ 895 (+XL) | |

SENSOR DE TEMPERATURA / TEMPERATURE SENDER

| | | | |
|--------------------------------|------------------------|---|--|
| 25/180-7 (3127956R1) | Rosca / Thread 1/2 BSP | 485, 495, 585, 595, 685, 695, 785, 795, 885, 895 (+XL) | |
| 25/180-8 (963418M1) | Rosca / Thread 3/8 BSP | 475 | |

Las referencias originales tienen un propósito identificativo.
Nuestras piezas no son originales.

Part numbers are quoted for reference purposes only.
Our parts and accessories are not original.



BOMBAS DE ACEITE
OIL PUMPS

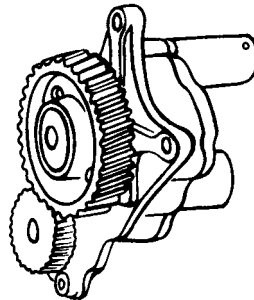

| Tractores Tractors | Motor Engine | Bomba de aceite Oil pump |
|---|-----------------------|---------------------------------|
| 385, 395, 3210 | D.155 (3 cil. / cyl.) | 25/90-35 (3136429R95) |
| 454, 484, 485, 485XL, 495, 495XL, 3220 | D.179 (3 cil. / cyl.) | |
| 474 (74) | D.206 (4 cil. / cyl.) | 25/90-37 (3136431R95) |
| 584, 585, 585XL, 595, 595XL, 3230 | | |
| 574, 674, 684, 685, 685XL, 695, 695XL, 4210 | D.239 (4 cil. / cyl.) | 25/90-36 (3136430R95) |
| 784, 785, 785XL, 795, 795XL, 4220, H84, H85 | D.246 (4 cil. / cyl.) | |
| 884, 885, 885XL, 895, 895XL, 995, 995XL, 4230, 4240 | D.268 (4 cil. / cyl.) | |

TOBERAS
INJECTOR NOZZLES

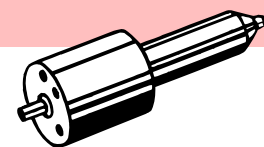
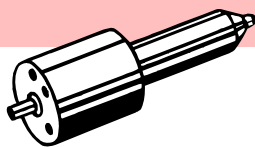

| Tractores Tractors | Presión Flow | Tobera Inj. nozzle | N° tobera N° on the injector nozzle |
|--|-----------------|----------------------------------|--|
| 250, 275, 276, 354, 374, 384, 414, 434, 444 | | 25/117-51 (3040871R91) | 434250056 BDN4SD6299 |
| 385, 395, 484, 485, 495, 584, 585, 595 (+XL) | 225 bars | 25/117-53 (3218248R2) | 433271838 DLLA150S836 |
| 684, 685, 695, 784, 785, 795, 884, 885, 895, 995 (+XL) | 225 bars | 25/117-52 (3218251R2) | 433271849 DLLA150S815 |

Las referencias originales tienen un propósito identificativo.
Nuestras piezas no son originales.

Part numbers are quoted for reference purposes only.
Our parts and accessories are not original.



**BOMBAS GAS-OIL
FUEL PUMPS**

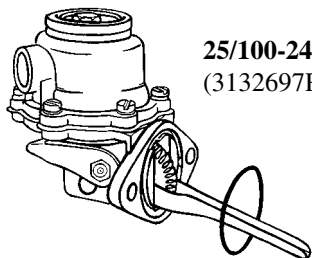

25/100-24
(3132697R92)

25/101-24 Juego de rep.
(3136002R91) *Repair Kit*

454, 474, 484, 485, 495, 574, 584,
585, 595, 674, 684, 685, 695, 784,
785, 795, 884, 885, 895,
3230, 4210, 4220, 4230 (+XL)
con bomba CAV / with CAV pump

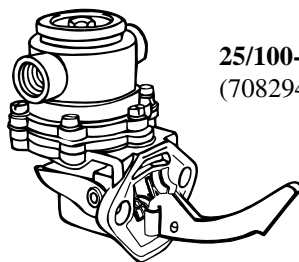

25/100-22
(708294R93)

25/101-22 Juego de rep.
(3066010R92) *Repair Kit*

250, 275, 276, 354, 374, 384,
414, 434, 444, 450

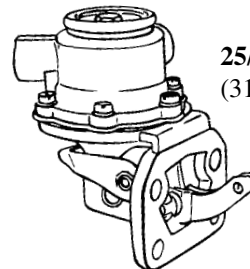

25/100-23
(3118234R91)

25/101-22 Juego de rep.
(3066010R92) *Repair Kit*

475

**CALENTADORES
HEATER PLUGS**

25/60-8
(710348R1)



250, 275, 276, 354, 374,
384, 414, 434, 444

25/60-6
(3112805R91)

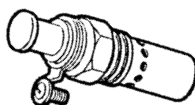

454, 474, 475, 574, 674

25/60-10
(K928523)

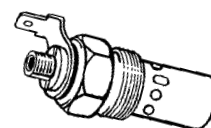

385, 395, 484, 485, 495, 584, 585,
595, 684, 685, 695, 784, 785, 795,
884, 885, 895 (+XL)

**CORREAS VENTILADOR
FAN BELTS**

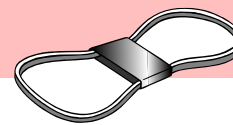
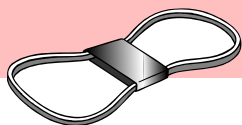

| Tractores <i>Tractors</i> | Alternador <i>Alternator</i> | Bomba de agua <i>Water pump</i> | Generador <i>Dynamo</i> |
|---|--|--|--|
| 275, 276, 278, 354, 374, 384, 414, 434, 444 | | 71/144-23 (709502R1) (AVX.17-900) | 71/144-11 (704449R1) (AVX.13-800) |
| 385, 395, 454, 484, 485, 495 | 71/144-25 (3129139R1) (AVX.13-1575) | | |
| 474, 574, 585, 595, 674, 685, 584, 684, 695, 784, 785, 795, 884, 885, 895 | 71/144-26 (3129140R1) (AVX.13-1540) | | |
| 475 | 71/144-24 (3055715R1) (AVX.13-1300) | | |

Las referencias originales tienen un propósito identificativo.
Nuestras piezas no son originales.

Part numbers are quoted for reference purposes only.
Our parts and accessories are not original.



BOMBAS DE AGUA Y JUEGO DE REPARACIÓN
WATER PUMPS AND REPAIR KITS

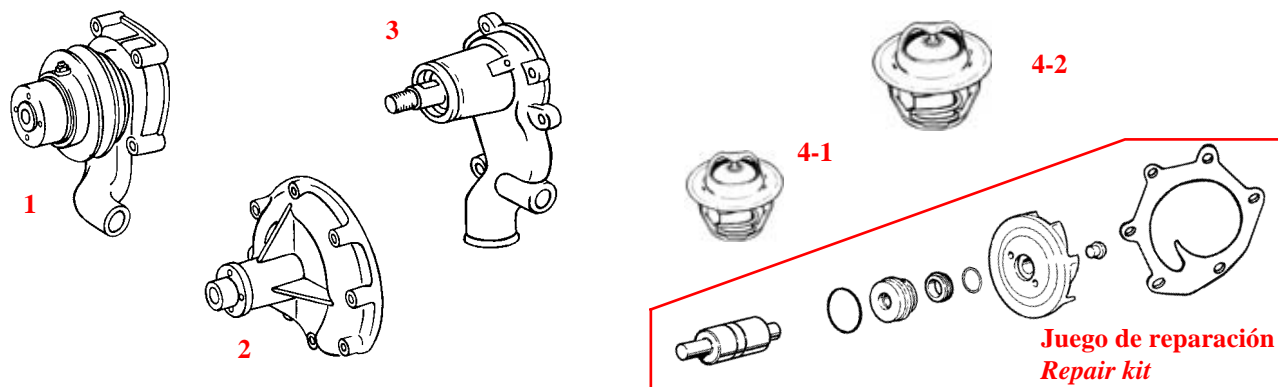



| Tractores Tractors | Fig. | OEM | Bomba de agua Water pump | Turbina Impellor | Juego de reparación Repair kit | Termostato Thermostats |
|--|----------|---------------------------------------|-----------------------------|---------------------|--|---|
| B.250, 275, 276, 354, 374, 384, 414, 434, 444 | 1 | 3065132R92 3119778R92 703820R95 | 25/130-25 (A) | 112mm | 25/131-25 (1094021R91) | 25/143-15 (3042303R92) 82° 4-1 |
| 385, 395, 454, 474, 484, 485, 495, 574, 584, 585, 595, 674, 684, 685, 695, 784, 785, 795, 884, 885, 895, 995 (+ XL), 3210, 3220, 3230, 4210, 4220, 4230, 4240 | 2 | 3136053R92 3132739R93 | 25/130-28 (B) | 112mm 98mm | 25/131-28 (3055285R94) 25/131-27 (1094012R91) | 25/143-17 (3059676R91) 82° 4-2 |
| 475 | 3 | 3118125R91 | 25/130-26 | 78mm | 25/131-26 (3118126R91) | 25/143-16 (3118127R1) 78° 4-1 |

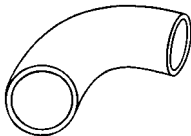

(A) Con polea / With pulley
(B) Sin polea / Less pulley

REFRIGERACIÓN
COOLING

MANGUITOS BOMBA DE AGUA / BY-PASS HOSES

| | | |
|---|---|--|
| <p>25/142-6 (3132719R1)</p>  <p>585, 595, 685, 695, 785, 795, 885, 895 (+XL) con air. acon. / with air conditioning</p> | <p>25/142-5 (3144028R1)</p> <p>385, 395, 484, 485, 495, 584, 585, 595, 684, 685, 695, 784, 785, 795, 884, 885, 895</p> <p>25/142-4 (3132144R1)</p> <p>Modelos antiguos Old models</p> | <p>25/141-9 (3065127R1)</p>  <p>275, 276, 354, 374, 384, 414, 434, 444</p> |
|---|---|--|

TAPONES RADIADOR / RADIATOR CAPS

| | |
|---|---|
| <p>25/151-11 (3111424R91)</p>  <p>275, 276, 354, 374, 384, 414, 434, 444, 475</p> | <p>25/151-12 (1500626C91)</p>  <p>385, 395, 454, 474, 484, 485, 495, 574, 584, 585, 595, 674, 684, 685, 695, 784, 785, 795, 884, 885, 895</p> |
|---|---|

Las referencias originales tienen un propósito identificativo.
Nuestras piezas no son originales.

Part numbers are quoted for reference purposes only.
Our parts and accessories are not original.



MANGUITOS RADIADOR
COOLING HOSES

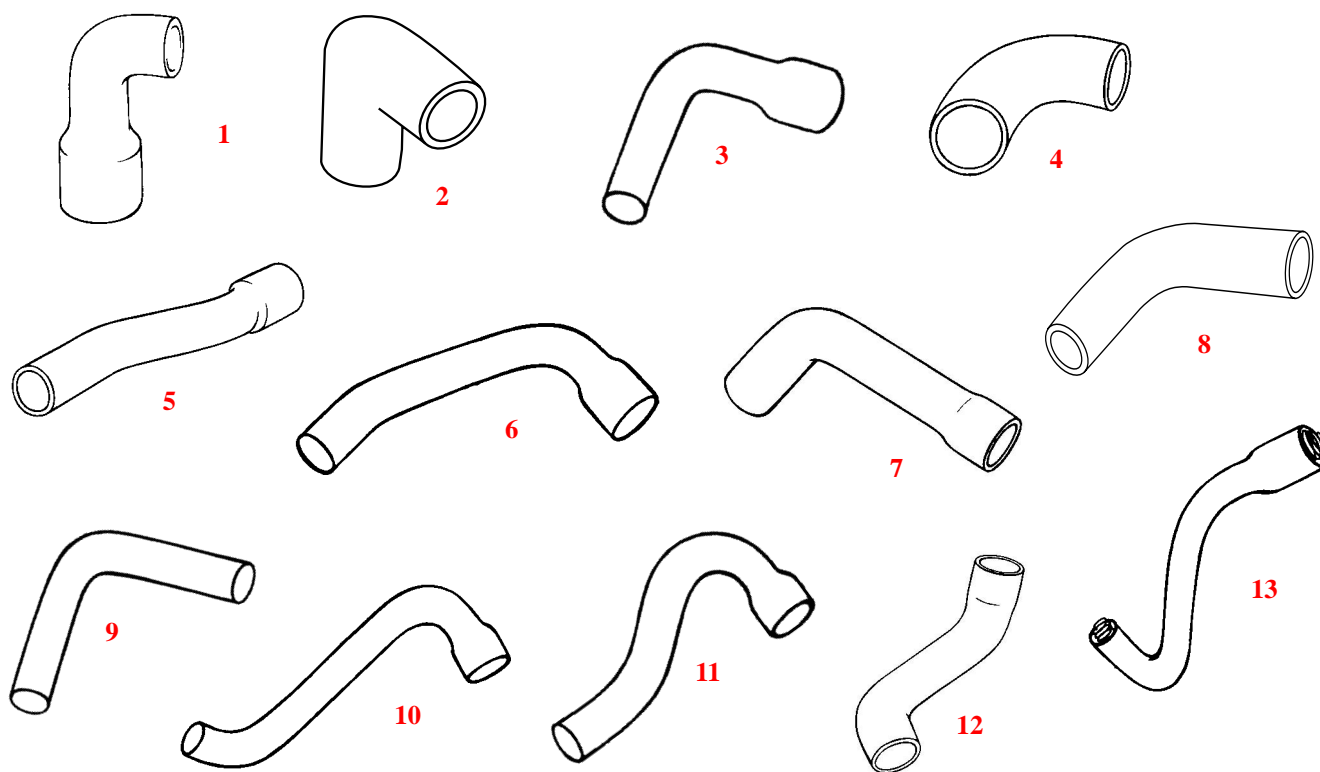

| Tractores Tractors | Fig. | Superior Top hose | Fig. | Inferior Bottom hose |
|---|------|---------------------------------------|------|--------------------------|
| 275 | 1 | 25/153-24 (704289R2) (↔ 46506) | 8 | 25/154-26 (704287R2) |
| | 2 | 25/153-26 (3065130R1) (46507 ↔) | | |
| 414 (↔ 30924) | 3 | 25/153-25 (3042414R1) | 9 | 25/154-27 (3044009R1) |
| 276, 414 (30925 ↔), 434 | 4 | 25/153-27 (3065129R1) | | |
| 354, 374, 384, 444 | | 25/153-28 (3112067R1) | | |
| 385, 395, 454, 485, 495 | 5 | 25/153-29 (402191R1) | 10 | 25/154-29 (402189R1) |
| 474, 574, 584, 585, 595, 674, 684, 685, 695, 784, 785, 795, 884, 885, 895 | 6 | 25/153-31 (402207R1) | 11 | 25/154-31 (402205R1) |
| 475 | 7 | 25/153-30 (3116665R2) | 12 | 25/154-30 (3116664R2) |
| 585, 595, 685, 695, 785, 795, 885, 895 (+XL) con air. acon. /with air conditioning | 6 | 25/153-90 (84496C1) | 13 | 25/154-90 (84497C1) |

Las referencias originales tienen un propósito identificativo.
Nuestras piezas no son originales.

Part numbers are quoted for reference purposes only.
Our parts and accessories are not original.



**FILTROS
FILTERS**

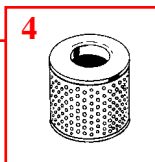
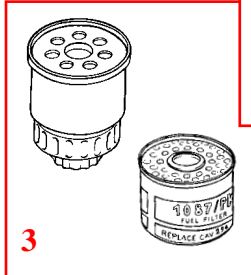
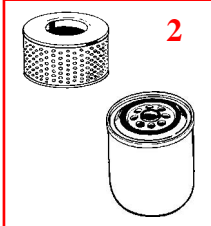
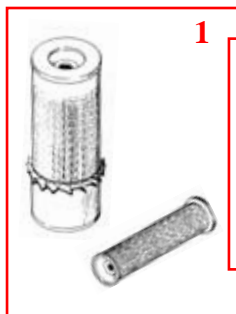

Filtros de agua / Water filter

258, 268, 288, 485, 495, 585, 595, 685, 695, 785, 795, 884, 885, 895, 985, 995, 3210, 3220, 3230, 4210, 4220, 4230, 4240 (+XL)

60/156-3
(A77544)



| Tractores Tractors | 1 Aire / Air | | 2 | 3 | 4 |
|---|---|--|--------------------------------|--|---|
| | Ext. / Out. | Int. / Inn. | Aceite Oil | Combustible Fuel | Hidráulico Hydraulic |
| 250, 275 (1959 ⇄ 1961) | | | 60/96-5 (705747R91) | 60/111-2 (704640R91) o / or 60/111-3 (1502155C91) (Reempl. CAV 296) | |
| 275, 276, 354, 374, 384, 414, 434, 444 | | | 60/96-1 (3110452R91) | | |
| 384, 454, 474, 484, 574, 584, 674, 684, 784 | 60/161-15 (529854R2) (Sin agujero de fijación / Less fixing's hole) | 60/162-16 (3115569R2) | 60/97-9 (3136046R93) | 60/111-3 (1502155C91) (Reempl. CAV 296) | |
| 475 | 60/161-15 (529854R2) (Sin agujero de fijación / Less fixing's hole) | | 60/97-27 (3118119R1) | | |
| 385, 395, 485, 495, 585, 595, 685, 695, 785, 795, 885 (+XL) Sin air. acon. Less air conditionning | 60/161-16 (3125199R2) (Con agujero de fijación / With fixing's hole) | 60/162-16 (3115569R2) | 60/97-9 (3136046R93) | 60/111-3 (1502155C91) (Reempl. CAV 296) o / or | 60/240-42 (530144R92) Alt/ Ht.: 77mm |
| 585XL, 595XL, 685XL, 695XL, 785 (+XL) 795 (+XL), 885 (+XL), 895 (+XL) Con air. acon. With air conditionning | 60/161-17 (3125342R2) Alt/ Ht.: 290mm | 60/162-17 (3125255R1) Alt/ Ht.: 255mm | | 60/111-16 (3132428R2) (Con purgador With steam trap) o / or 60/111-25 (3218793R91) (Repl. CAV 496) | |
| 884, 895, 4210, 4220, 4230 (+XL), 85+ | | | 60/97-12 (1329020C2) | 60/111-16 (3132428R2) | |
| 3210, 3220, 3230 | 60/161-16 (3125199R2) | 60/162-16 (3115569R2) | 60/97-37 (398080R2) | 60/111-25 (3218793R91) (Reempl. CAV 496) | |

Las referencias originales tienen un propósito identificativo.
Nuestras piezas no son originales.



Part numbers are quoted for reference purposes only.
Our parts and accessories are not original.



"THE RELIABLE SERVICE"



FILTROS
FILTERS
CUBETAS CRISTAL / GLASS FUEL BOWLS

| | | |
|--------------------------------|---|---|
| 25/112-1 (3069610R1) |  | Tipo / Type : CAV Base plana/ Flat bottom Alt./ Height 54 mm Ø agujero/ hole Ø : 25,4 mm |
| 25/112-4 (3144478R1) |  | Tipo / Type : BOSCH Base convexa/ Convex bottom Alt./ Height 48 mm Ø agujero/ hole Ø : 9 mm |
| 25/112-5 (3132197R1) |  | Tipo / Type : BOSCH Base convexa/ Convex bottom Alt./ Height 43 mm Ø agujero/ hole Ø : 17,4 mm |

FILTRO DE CABINA
CAB FILTER

Cabina XL Cab

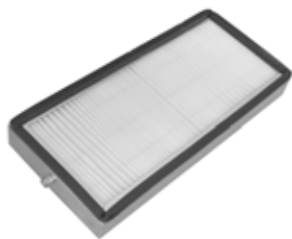
60/4200-2
 (3233584R2)
 325x150x43mm

LISTA DE REFERENCIAS CRUZADAS DE FILTROS
FILTERS CROSS-REFERENCE
Antigua Ref. / Old ref.

| ANT. REF. OLD REF. | REF. N° ORDER N° |
|-----------------------|---------------------|
| 03115/569 R2 | 60/162-16 |
| 03116609R92 | 60/97-9 |
| 03125199R2 | 60/161-16 |
| 03125255R1 | 60/162-17 |
| 03125342R2 | 60/161-17 |
| 03132737R93 | 60/97-12 |
| 0529854R2 | 60/161-15 |
| 0530144R92 | 60/240-42 |
| 110 | 60/96-5 |
| 111 | 60/96-1 |
| 439 | 60/97-27 |
| 1005 | 60/111-2 |
| 1087/PK | 60/111-3 |
| 1194/F | 60/111-16 |
| 5006/F | 60/111-25 |
| 9667 | 60/162-18 |

Ref. n° / Order N°

| REF. N° ORDER N° | ANT. REF. OLD REF. |
|---------------------|-----------------------|
| 60/96-1 | 111 |
| 60/96-5 | 110 |
| 60/97-9 | 03116609R92 |
| 60/97-12 | 03132737R93 |
| 60/97-27 | 439 |
| 60/111-2 | 1005 |
| 60/111-3 | 1087/PK |
| 60/111-16 | 1194/F |
| 60/111-25 | 5006/F |
| 60/161-15 | 0529854R2 |
| 60/161-16 | 03125199R2 |
| 60/161-17 | 03125342R2 |
| 60/162-16 | 03115/569 R2 |
| 60/162-17 | 03125255R1 |
| 60/162-18 | 9667 |
| 60/240-42 | 0530144R92 |

 Las referencias originales tienen un propósito identificativo.
 Nuestras piezas no son originales.

 Part numbers are quoted for reference purposes only.
 Our parts and accessories are not original.

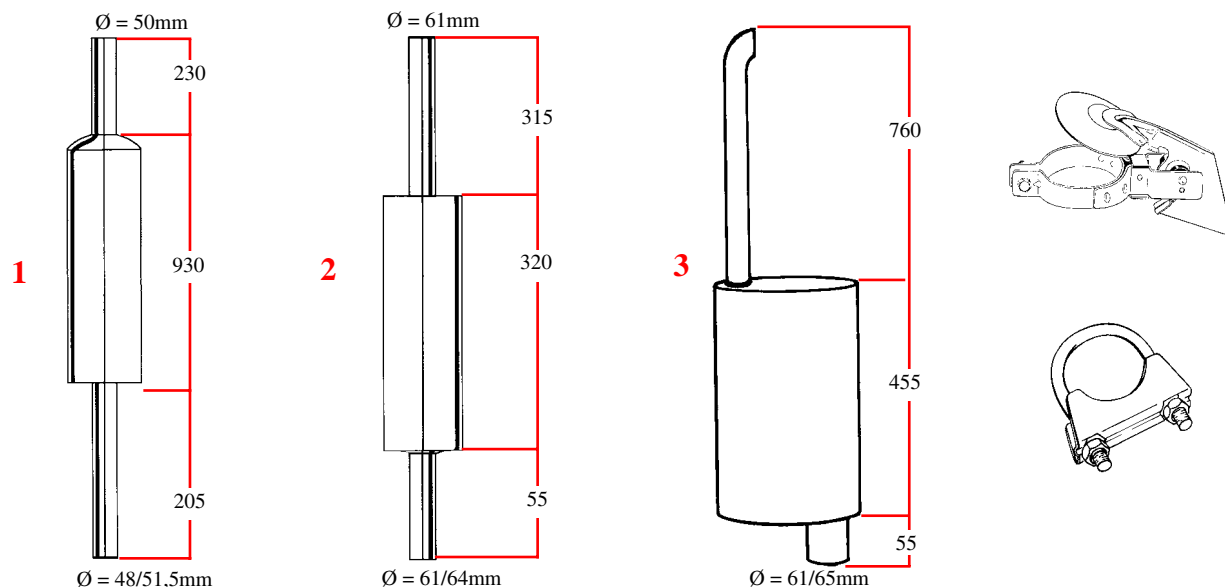

**SILENCIOSOS (VERTICAL)
MUFFLERS (VERTICAL)**



| Tractores Tractors | Fig. | Silecioso Mufflers | Tapa Weathercap | Abrazadera Exhaust clamp |
|---|------|---------------------------|-------------------------|-----------------------------|
| 275, 276, 354, 374, 384, 414, 434, 444 | 1 | 25/165-30 (3109792R92) | 70/2930-51 (5870/21) | 70/2935-54 (MC5856) |
| 454, 474, 574, 674 | 2 | 25/165-31 (529372R1) | 70/2930-64 (5870/23) | |
| 385, 395, 484, 485, 495, 584, 585, 595, 684, 685, 695, 784, 785, 795, 884, 885, 895 | 3 | 25/165-32 (83027C1) | | 70/2935-64 (MC5865) |

**PROTECCIONES CONTRA INCENDIO
EXHAUST PIPE SPARK ARRESTOR**

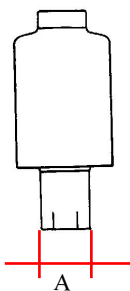
¡ ALTO EL FUEGO ! / MINIMIZE THE FIRE HAZARD !



Maxima protección para prevención de incendios;
Maximum protection against fire on saw mills, forest works, crop harvest operations ...

70/165-400X - Ø A 2" (50,80mm)
(TFCM.06/0037)

70/165-401X - Ø A 2,5" (63,50mm)
(TFCM.06/5030)

No podemos hacernos responsables del posible incendio producido por una maquina equipada con parador de chispas.
We cannot accept liability in the event of fire on a machine fitted with a spark arrestor.



**OPTICAS
LIGHTING**

FAROS DELANTEROS "LUCAS" FRONT LIGHT

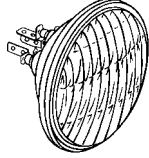
| | | | |
|----------------------------------|--|--|--|
| 25/181-17 (3072947R91) | Faro Ø 111mm (Sealed Beam) <i>Head lamp Ø 111mm (Sealed Beam)</i> |  | 275, 276, 354, 364, 374, 434, 454, 574, 674 |
| 25/181-18 (3129035R1) | Faro Ø 143mm (Sealed Beam) <i>Head lamp Ø 143mm (Sealed Beam)</i> | | 384, 385, 395, 484, 485, 495, 584, 585, 595, 684, 685, 695, 784, 785, 795, 884, 885, 895 |

LUZ DE MATRÍCULA / LIGHTNING PLATE

| | | | | |
|------------------|------------|---|---|--|
| 63/1920-6 | 3231505R91 | Eclaire-plaque <i>Luz de matrícula</i> |  | 433, 440, 533, 540, 633, 640, 733, 740, 743, 743XL, 745S, 745XL, 833, 840, 844S, 844XL, 845, 845XL, 856XL, 940, 955XL, 956, 956XL, 1055XL, 1056, 1056XL, 1255, 1255XL, 1455, 1455XL, 5120, 5130, 5140, 5150, CX50, CX60, MX100, MX110, MX120, MX135, MX180, MX200, MX220, MX240, MX270 |
|------------------|------------|---|---|--|

**FAROS DE TRABAJO
WORK LIGHTS**

63/1931-6
(ET.1251/H)

182 x 100mm
Luz halogena H3

*182 x 100mm
Halogen H3*

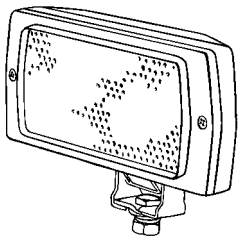

Bombillas / Bulbs : **63/1955-453** : 12V./55W
(10/12336)
63/1955-460 : 24V./70W
(10/13336)

63/1931-7
(ET.1181/F)

Ø 140mm
Luz halogena H3
Con rejilla e interruptor

*Ø 140mm
Halogen H3
With grill and switch*

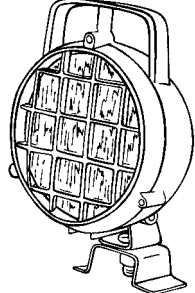

Bombillas / Bulbs : **63/1955-453** : 12V./55W
(10/12336)
63/1955-460 : 24V./70W
(10/13336)

63/1931-8
(10/752M)

Carcasa de acero lacado
127 x 47 x 65mm
Luz halogena H3

*Metallic housing
127 x 47 x 65mm
Halogen H3*

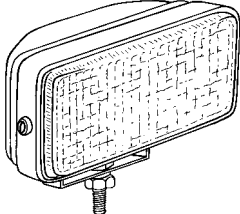

Bombillas / Bulbs : **63/1955-453** : 12V./55W
(10/12336)
63/1955-460 : 24V./70W
(10/13336)

63/1931-2

Montaje "RAYDYOT" Fitting
Serie XL serie

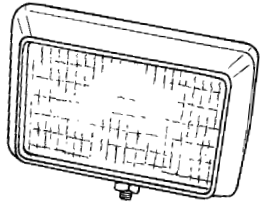

Bombillas / Bulbs : **63/1955-453** : 12V./55W
(10/12336)
63/1955-460 : 24V./70W
(10/13336)

Otras clases de luces se pueden encontrar en la sección de luces en la 1. parte del catálogo
Other suitable lights can be found in the lighting section (part I of the catalogue).



Las referencias originales tienen un propósito identificativo.
Nuestras piezas no son originales.

*Part numbers are quoted for reference purposes only.
Our parts and accessories are not original.*



INSTRUMENTOS DIVERSOS
MISCELLANEOUS ITEMS

CABLES CUENTA-HORAS
DRIVE CABLES



25/177-20 275
(1962381C1) Lg. = 1750mm

25/177-21 484, 584, 485, 585, 685, 784, 785
(1970820C1) Con cabina / with cab
SUPER DE LUXE : 385, 485, 585,
684, 685, 784, 785, 885
Lg. = 1500mm

25/177-22 485, 495 (+XL)
(1500491C1) Lg. = 1300mm

25/177-23 585, 595, 685, 695, 785, 795,
(1500716C1) 885, 895 (+XL)
Lg. = 1850mm

CABLE STOP / STOP CABLE

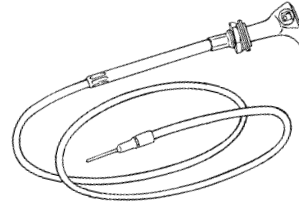

25/107-2
(R9331K)

Lg. 1700mm

FLOTADOR
SENDER UNIT

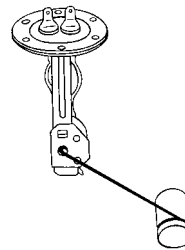

25/172-16
(1500494C92)

485XL, 495XL, 585XL,
595XL, 685, 685XL, 695XL,
785, 785XL, 795XL, 885,
885XL, 895XL

FRENO DE MANO / HAND BRAKE

25/324-4
(1971050C1)

Cinta freno mano / Hand brake band
Séries 74, 84, 85, 95 series
454, 475

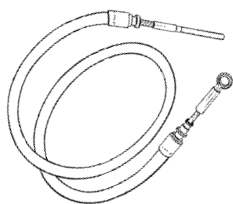
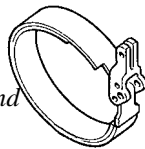

25/409-15
(1500021C1)

Cable freno mano / Brake cable
385, 395, 454, 474, 475, 484,
485, 495, 574, 584, 585, 595,
674, 684, 685, 695, 784, 785,
795, 884

INTERRUPTOR DE ARRANQUE / STARTER SWITCH

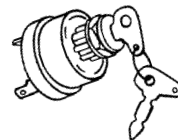

63/950-2
(3119716R91)

Tipo / Type "LUCAS"
Con llaves/ with keys

Ver nuestro gama completa en el fascículo 1
del catálogo general / For further details,
see the complete range in part 1 of the catalogue .



EMBRAGUES Y DISCOS DE EMBRAGUE
CLUTCH ASSEMBLIES & PLATES

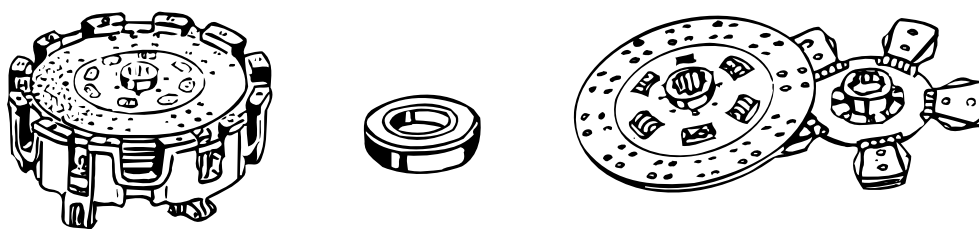

| TRACTORES TRACTORS | EMBRAGUE CLUTCH | | DISCO PLATE | | RODAMIENTO EMPUJE RELEASE BEARING |
|-----------------------------|------------------------------------|--|------------------------------|--|---|
| | Ø | REF.Nº ORDER N° | Ø | REF.Nº ORDER N° | |
| 275, 276, 354 | 10" 250 | 25/200-39 (705525R91) | 10" 250 (A) | 25/221-39 10Z 23x29 (3040412R91) | 25/231-9 (705542R91) Aro de carbono Carbon ring Ø int.41,5mm Ø inner 41,5mm 25/230-7 (RV) (751848R94) |
| | 230/280 3 patillas 3 fingers | 25/200-50 (709638R95) | 230 (A) 280 (A) | 25/212-11 (LK) 10Z 38x45 (709640R92) 25/221-50 (LN) 10Z 23x29 (709639R94) | 25/231-10 70x103x21,5 (3070635R91) 25/230-7 (RV) (751848R94) |
| 275 (⇔ 50975) | 11" 280 | 25/200-41 (3062712R94) Reglaje 12mm Spacers on pressing | 280 (A) | 25/221-41 10Z 23x29 (3062713R91) | 25/231-10 70x103x21,5 (3070635R91) 25/230-7 (RV) (751848R94) |
| 275 (50976 ⇔) 276 354 | 11" 280 | 25/200-43 (3067300R92) Reglaje 6mm Spacers on pressing | 280 (B) | 25/221-43 10Z 23x29 (3074827R91) | 25/231-10 70x103x21,5 (3070635R91) 25/230-7 (RV) (751848R94) |
| | | | | | |

Las referencias originales tienen un propósito identificativo.
Nuestras piezas no son originales.

Part numbers are quoted for reference purposes only.
Our parts and accessories are not original.



| TRACTEURS TRACTORS | EMBRAGUE CLUTCH | | DISCO PLATE | | RODAMIENTO EMPUJE RELEASE BEARING |
|---------------------------|---|---|----------------|--|--|
| | Ø | REF.N° ORDER N° | Ø | REF.N° ORDER N° | |
| 374, 384 434, 444 | 11" 280 | 25/200-40 (3048528R91) | 280 (A) | 25/221-40 10Z 23x29 (3048529R91) | 25/231-9 (705542R91) Aro de carbono <i>Carbon ring</i> Ø int.41,5mm Ø inner 41,5mm 25/230-7 (RV) (751848R94) |
| | 11" 280 | 25/200-43 (3067300R92) Reglaje 6mm <i>Spacers on pressing</i> | 280 (B) | 25/221-43 10Z 23x29 (3074827R91) | 25/231-10 70x103x21,5 (3070635R91) 25/230-7 (RV) (751848R94) |
| 374, 384 414, 434, 444 | 230/280 3 patillas <i>3 fingers</i> | 25/200-51 (3047747R93) | 230 (A) | 25/212-11 (LK) 10Z 38x45 (709640R92) | 25/231-10 70x103x21,5 (3070635R91) 25/230-7 (RV) (751848R94) |
| | | | 280 (A) | 25/221-51 (LN) 10Z 23x29 (3108790R91) | |
| | | | 280 (A) | 25/221-51E (LN) (VZ) 10Z 23x29 (3108790R91) | |
| 414 | 11" 280 | 25/200-40 (3048528R91) | 280 (A) | 25/221-40 10Z 23x29 (3048529R91) | 25/231-9 (705542R91) Aro de carbono <i>Carbon ring</i> Ø int.41,5mm Ø inner.41,5mm 25/230-7 (RV) (751848R94) |
| 414 (⇔ 50914) | 11" 280 | 25/200-42 (3048589R91) | 280 (A) | 25/221-42 10Z 23x29 (3048590R91) | 25/231-10 70x103x21,5 (3070635R91) 25/230-7 (RV) (751848R94) |
| 414 (50915 ⇔) | 11" 280 | 25/200-43 (3067300R92) Reglaje 6mm <i>Spacers on pressing</i> | 280 (B) | 25/221-43 10Z 23x29 (3074827R91) | 25/231-10 70x103x21,5 (3070635R91) 25/230-7 (RV) (751848R94) |

Las referencias originales tienen un propósito identificativo.
Nuestras piezas no son originales.

Part numbers are quoted for reference purposes only.
Our parts and accessories are not original.



"THE RELIABLE SERVICE"



| TRACTEURS TRACTORS | EMBRAGUE CLUTCH | | DISCO PLATE | | RODAMIENTO EMPUJE RELEASE BEARING |
|---|--|---|--|--|--|
| | Ø | REF.N° ORDER N° | Ø | REF.N° ORDER N° | |
| 385, 395, 454, 474, 475, 484, 485, 495, 574, 584, 585, 595, 674, 684, 685, 695, 784, 785, 795, 884, 885, 895 | 11" 280 o / or 11" 280 | 25/200-45 (1500655C91) 25/200-46 (92602C91) doble muelle <i>double springs</i> | 280 (B) o / or 280 (B) 280 (B) | 25/221-44 (D) 10Z 23x29 (3121506R92) 25/221-45 (F) 10Z 23x29 (3121507R92) 25/221-46 (H) 10Z 23x29 (3129834R1) | 25/231-11 60 x 102 x 20,5 (85104C92) 25/230-8 (RV) (69844C91) |
| 385, 474, 475, 484, 584, 585, 595, 685, 695, 785, 795, 885, 895, 985, 995, 3210, 3230, 4210, 4220, 4230, 4240 | 310 | 25/200-110 (131003810, 85025C2) | 310 (B) | 25/221-110 (F) 10Z 23x29 (331015410, 85026C3) | 25/231-11 60 x 102 x 20,5 (85104C92) 25/230-8 (RV) (69844C91) |
| 3210, 3220, 3230, 3400, 3500 | 280 | 25/200-46 (92602C91) doble muelle <i>double springs</i> | 280 (B) 280 | 25/221-45 (F) 10Z 23x29 (3121507R92) 25/221-46 (H) 10Z 23x29 (3129834R1) | 25/231-11 60 x 102 x 20,5 (85104C92) 25/230-8 (RV) (69844C91) |

Embrague completo con disco
Complete clutch assembly with plate

25/200-198K - (25/200-46 + 25/221-45)
25/200-199K - (25/200-46 + 25/221-46)

Embrague completo con disco
Complete clutch assembly with plate

25/200-208K

- (Z) Dientes
- (A) Revestimiento orgánico sin amianto
- (B) Revestimiento cerámético
- (D) Con 4 palas
- (F) Con 6 palas
- (H) Con 8 palas
- (LK) Disco TdF, Transmisión lateral montada
- (LN) Disco principal, lado motor libre
- (RV) Cojinete
- (VZ) Versión económica

- (Z) *Teeth*
- (A) *Asbestos free organic lining*
- (B) *Ceramic lining*
- (D) *4 pairs of pads*
- (F) *6 pairs of pads*
- (H) *8 pairs of pads*
- (LK) *PTO disc, transmission side, mounted*
- (LN) *Main disc, engine side, loose*
- (RV) *Pilot bearing*
- (VZ) *Economic version*

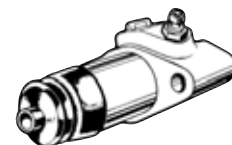

CILINDROS PRINCIPAL Y AYUDA EMBRAGUE
MASTER & SLAVE CLUTCH CYLINDERS

| Tractores Tractors | Cil. principal Master cyl. | Juego rep. cil. principal Master cyl. repair kit | Juego rep. cil. ayuda slave cyl. repair kit |
|---|---------------------------------|---|--|
| 485XL, 495XL, 585XL, 595XL, 685XL, 695XL, 785XL, 795XL, 885XL, 895XL, 995XL, 3210, 3220, 3230, 3220XL, 3230XL, 4210, 4220, 4230, 4240, 4210XL, 4220XL, 4230XL, 4240XL | 25/226-4 (3129807R92) | 25/227-4 (N7602) | 25/229-4 (80318C91) |

Las referencias originales tienen un propósito identificativo.
Nuestras piezas no son originales.

Part numbers are quoted for reference purposes only.
Our parts and accessories are not original.



**FRENO
BRAKES**

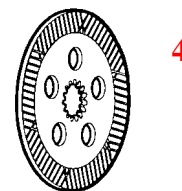
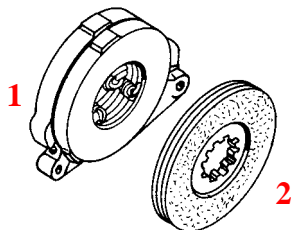

Juego de 4 zapatas
con remaches
Set of 4 with rivets

Acero
Steel

| Fig. | 1 | 2 | Ø | 3 | 4 |
|--|--|----------------------------------|---------|----------------------------------|-------------------------------|
| Tractores Tractors | DISCO DE FRENO (SECO) / BRAKE DISCS (DRY) | | | | |
| 250, 275 (⇨ 46662), 414 (⇨ 31374) | | 25/420-15 (704422R93) | Ø 140mm | 25/421-15 (3134668R3) | |
| 275, 276, 354, 374, 384, 414, 434, 444 | 25/417-16 (786460R21) | 25/420-16 (3064170R91) | Ø 165mm | 25/421-16 (3040152R92) | |
| Tractores Tractors | DISCO DE FRENO (EN BAÑO DE ACEITE) / BRAKE DISCS (OIL BATH) | | | | |
| 454, 474, 574, 674, 484, 584, 684, 784, 884, 385, 485, 585, 685, 785, 885, 985 (+ serie 95 serie) + XL | | | Ø 260mm | | 25/420-6 (114622C2) |
| Importante : Utilizar unicamente el aceite "HYTRAN" / Important : Only use HYTRAN oil | | | | | |



**CILINDROS PRINCIPALES (FRENO)
MASTER BRAKE CYLINDERS**

| Tractores Tractors | Cilindro principal Master cyl. | Juego de reparación Repair kit |
|---|--|---|
| 248, 278, 385, 454, 474, 475, 484, 485, 574, 584, 585, 674, 684, 685, 784, 785, 884, 885 | 25/410-14 (527542R92) 2 entradas / ports | 25/411-14 (3125824R1) |
| 238, 248, 258, 268, 288, 385, 395, 485, 495, 585, 595, 685, 695, 785, 795, 885, 895 3210, 3220, 3230, 4210, 4220, 4230 (Sin cabina / Less cab) | 25/410-15 (1287843C92) 3 entradas / ports | 25/411-13 (1288228C1) |
| 395, 495, 595, 695, 795, 895 | 25/410-16 (1971138C1) Doble bloqueo Dual block | |
| 485XL, 495XL, 585XL, 595XL, 685XL, 695XL, 785XL, 795XL, 885XL, 895XL, 995XL, 3210, 3220, 3230, 3220XL, 3230XL, 4210, 4220, 4230, 4240, 4210XL, 4220XL, 4230XL, 4240XL | 25/410-12 (1287734C92) | 25/411-12 (1288229C1) |
| 485XL, 585XL, 685XL, 785XL, 885XL | 25/410-13 (3129643R91) | 25/411-13 (1288228C1) |

Las referencias originales tienen un propósito identificativo.
Nuestras piezas no son originales.

Part numbers are quoted for reference purposes only.
Our parts and accessories are not original.



PIEZAS PARA EL EJE DELANTERO
FRONT AXLE PARTS

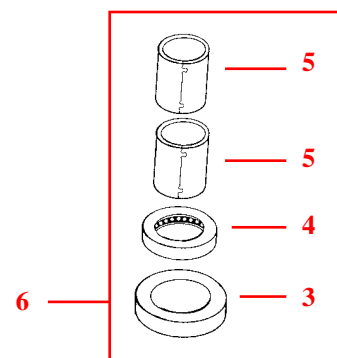
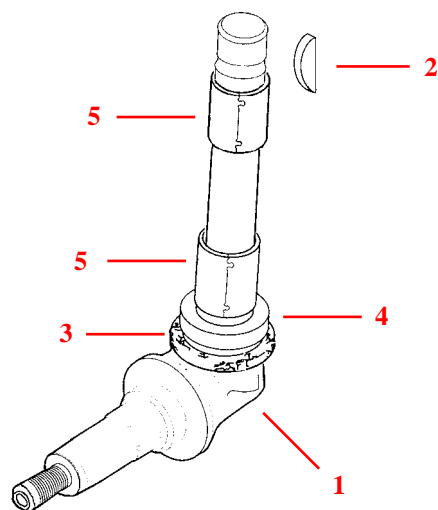
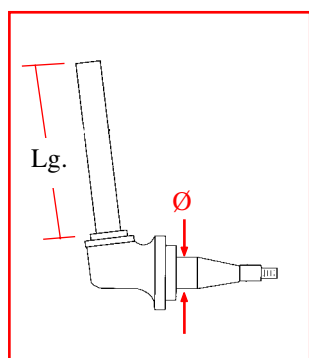

| Fig. | 1 | 2 | 3 | 4 | 5 | 6 |
|---|--|--------------------------------|-------------------------------|----------------------------------|--------------------------------|--|
| Tractores Tractors | Mangueta Spindle | Eje Key | Retén Seal | Rodamiento Bearing | Casquillo Bush | Juego Rings kit |
| 275, 276, 354, 374, 384, 414, 434 | | | | 25/479-13 (3070055R91) | 25/477-13 (40090D) | 25/475-16 (B1265) |
| 454, 474, 475, 484, 485, 495, 574, 584, 585, 595, 674 (Eje normal ⇄ 101082) (Standard axle ⇄ 101082) | 25/470-68 (405840R12) Lg. = 308 Ø 35mm | 25/2830-150 (117997) | 25/476-12 (15943DA) | 25/479-14 (527295R91) | 25/477-14 (376099R1) | 25/475-17 (B1266) Juego para 1 mangueta Kit 1 spindle |
| | 25/470-69 (527292R92) Lg. = 388 Ø 35mm | | | | | |
| 25/470-71 (67535C91) Lg. = 308 Ø 45mm | | | | | | |
| 25/470-70 (67526C91) Lg. = 388 Ø 45mm | | | | | | |
| 454, 474, 475, 484, 485, 495, 574, 584, 585, 595, 674 (+XL) (Eje reforzado 101083 ⇄) (Heavy duty axle 101083 ⇄) | | | | | | |
| 684, 685, 695, 784, 785, 795, 884, 885, 895 (+XL) | 25/470-67 (3121270R91) Lg. = 211 Ø 45mm | | | | | |
| | 25/470-66 (3121261R91) Lg. = 285 Ø 45mm | | | | | |

JUEGO DE REPARACIÓN PARA LA ROSCA DE LA MANGUETA
FRONT SPINDLE THREAD REPAIR KIT

70/457-2
(LN.10-2)

454 ⇄ 995 (+XL)
Rosca/ Thread 3/4" x 18 UNF

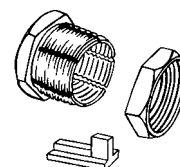

La tuerca interior cónica se colla sobre la rosca deteriorada y se cierra con la rosca exterior.
The inner cone nut is screwed on the worn thread and is locked by the outer nut.



PIEZAS PARA EL EJE DELANTERO
FRONT AXLE PARTS

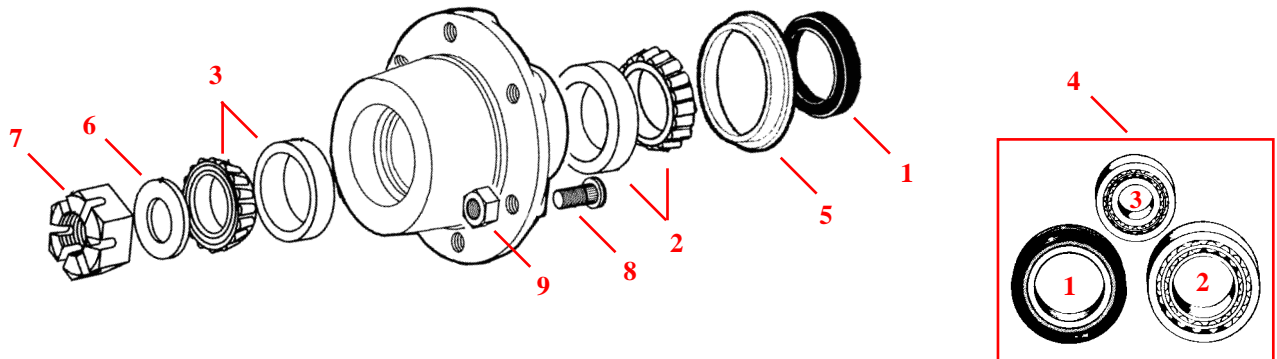

| Fig. | 1 | 2 | 3 | 4 | 5 |
|---|---|----------------------------------|----------------------------------|--|-------------------------------|
| Tractores Tractors | Retén Oil seal | Rodamiento int. Inner bearing | Rodamiento ext. Outer bearing | Juego rodamientos Bearings kit | Guía retén Wear ring |
| 275, 276, 354, 374, 384, 414, 434 | 25/461-17 (50259D) Filtro / Felt + 25/461-13 (704083R92) Retén / Oil seal | 25/462-13 (618022R91) | 25/463-13 (3043872R91) | 25/460-13 (1094017R92) | 25/464-1 (48548D) |
| 454, 474, 475, 484, 485, 495, 574, 584, 585, 595, 674 (Eje normal ⇄ 101082) (Standard axle ⇄ 101082) | 25/461-14 (530104R91) | 25/462-13 (618022R91) | 25/463-14 (371881R91) | 25/460-14 (1094015R92) Ø 35mm | 25/464-2 (406295R2) |
| 454, 474, 475, 484, 485, 495, 574, 584, 585, 595, 674 (+XL) (Eje reforzado 101083 ⇄) (Heavy duty axle 101083 ⇄) | 25/461-18 (370254R91) | 25/462-18 (400989C91) | 25/463-18 (536052R91) | 25/460-18 (1094034R93) Ø 45mm | 25/464-3 (67328C1) |
| 684, 685, 695, 784, 785, 795, 884, 885, 895 (+XL) | | | | | |

| Fig. | 6 | 7 | 8 | 9 |
|--|-------------------------------|-----------------------------|--------------------------------|-------------------------------|
| Tractores Tractors | Arandela Washer | Tuerca Nut | Tornillo Studs | Tuerca Nut |
| 275, 276, 354, 374, 384, 414, 434 | | | 25/446-9 (3047573R1) | |
| 454, 474, 475, 484, 485, 495, 574, 584, 585, 595, 674 (Eje normal ⇄ 101082) (Standard axle ⇄ 101082) | 25/451-5 (369857R1) | | | 25/447-4 (483879R2) |
| 454, 474, 475, 484, 485, 495, 574, 584, 585, 595, 674 (+XL) (Eje reforzado 101083 ⇄) (Heavy duty axle 101083 ⇄) | 25/451-6 (67537C1) | 25/452-1 (427639) | 25/452-1 (528803R1) | |
| 684, 685, 695, 784, 785, 795, 884, 885, 895 (+XL) | | | | |

Las referencias originales tienen un propósito identificativo.
Nuestras piezas no son originales.

Part numbers are quoted for reference purposes only.
Our parts and accessories are not original.



PIEZAS PUENTE DELANTERO Y DIRECCIÓN
FRONT AXLE PIN

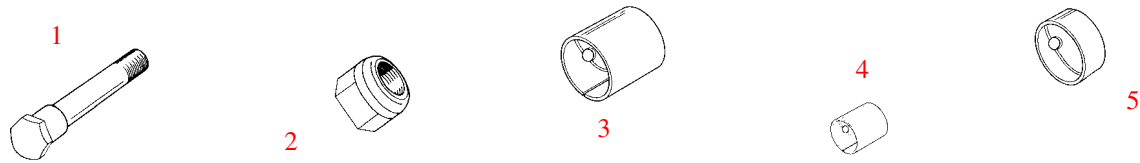

| Fig. | 1 | 2 | 3 | 4 | 5 |
|---|---------------------------------------|-------------------------------|---|--|--|
| Tractores <i>Tractors</i> | Clavija de unión <i>Pin</i> | Tuerca <i>Nut</i> | Casquillo <i>Ring (Front axle pin)</i> | Casquillo direcc. <i>Ring (Steering arm)</i> | Casquillo direcc. <i>Ring (Cylinder)</i> |
| 385, 395, 454, 474, 484, 485, 495, 574, 584, 585, 595, 674 (+XL) | 25/483-3 (405584R2) | 25/484-3 (405576R1) | 25/486-14 (405570R1) Ø int. 51,3 Ø inner 51,3 | 25/584-1 (405574R1) Ø int. 25,8 Ø inner 25,8 | 25/583-1 (379748R1) Ø int. 38,3 Ø inner 38,3 |
| 685, 695, 785, 795, 885, 895 (+XL) | | | | | |

TIRANTE (DIRECCIÓN ASISTIDA)
STEERING BAR (POWER STEERING)

454, 484, 574, 584, 674, 684, 784, 884,
385, 485, 585, 685, 785, 885 (+ type XL)
395, 495, 595, 695, 795, 895

25/572-1
(405580R11)

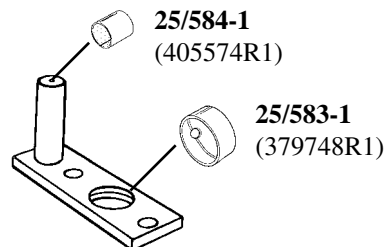

Ref. **25/582-1** (B58201) : Kit consta de 2 piezas de cada refs. :
Also available **25/582-1** (B58201) : Bush kit set consisting of 2 each of
25/583-1 (379748R1), **25/486-14** (405570R1) & **25/584-1** (405574R1)

LLANTAS DELANTERAS / RIMS

25/449-11
(704675R91)

Para neumáticos 550, 600 x 16
For tyres 550, 600 x 16

25/449-12
(3114166R91)

Para neumáticos 750 x 16
For tyres 750 x 16

25/449-13
(3121425R91)

Para neumáticos 750 x 18
For tyres 750 x 18

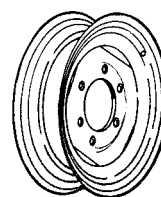

PIEZAS PARA EL EJE DELANTERO ZF
FRONT AXLE DRIVE ZF

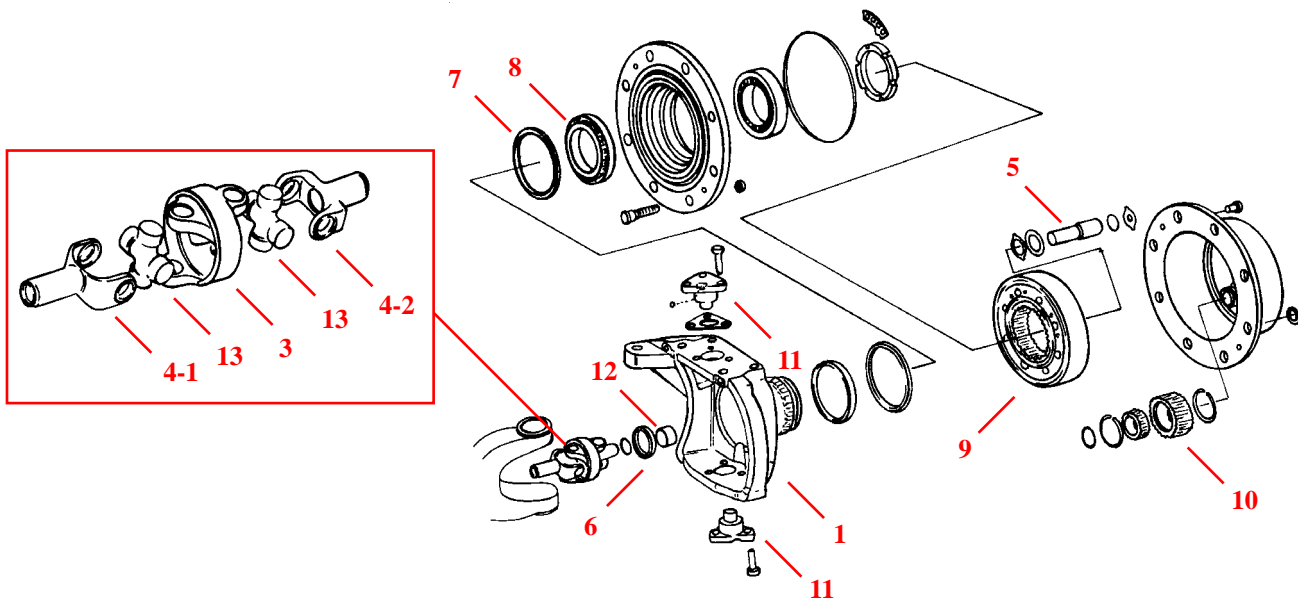

| ZF | APL325 | APL 330 | APL335 |
|-----|---|--|---|
| | 238, 248, 258, 395, 485, 495, 595 (+XL) | 238, 248, 258, 268, 288, 395, 495, 585, 595, 685, 695, 785, 795, 885, 895, 995 (+XL) | 258, 268, 288, 685, 785, 795, 885, 895, 995 (+XL) |
| 1 | 25/6400-4 (IZQ)(LH) (81413C1) | | 25/6400-9 (IZQ)(LH) (81291C1) |
| | 25/6400-5 (DCHA)(RH) (81414C1) | | 25/6400-10 (DCHA)(RH) (81292C1) |
| 3 | 25/6404-1 (1342710C1) | | |
| 4-1 | 25/6405-2 (1342712C1) | | 25/6405-8 (1342717C1) |
| 4-2 | 25/6405-1 (1342713C) | | 25/6405-9 (1342716C1) |
| 5 | 25/6406-1 (81453C1) | 25/6406-8 (81435C1) | 25/6406-9 (81320C1) |
| 6 | 25/6407-6 (81411C2) | | 25/6407-5 (81288C2) |
| 7 | 25/6408-7 (1964235C1) | | |
| 8 | 25/6410-8 (81312C2) | | |
| 9 | 25/6430-3 (81452C1) | 25/6430-10 (81414C1) | 25/6430-4 (81319C1) |
| 10 | 25/6431-4 (81455C1, 4472351134) | 25/6431-8 (81325C1) | |
| 11 | 25/6450-1 (81428C1) | | 25/6450-3 (81305C1) |
| 12 | 25/6462-2 (81429C2) | | 25/6462-8 (8136C2) |
| 13 | 25/6403-14 (1342711C1) | | |

Las referencias originales tienen un propósito identificativo.
Nuestras piezas no son originales.

Part numbers are quoted for reference purposes only.
Our parts and accessories are not original.



EJE DELANTERO Y CRUCETAS
FRONT AXLE - UNIVERSAL JOINT

| Bestell-Nr. Bestel Nr. | Org.-Nr. OEM Nr. | L x ø (mm) L x ø (mm) | Vorderachse Typ Vooras type | Abb. Afb. |
|---------------------------|------------------------|--------------------------|--|--------------|
| 25/6403-13 | 100546A1 | 61,3 x 23,8mm | Typ/ Type "Carraro" | C |
| 25/6403-14 | 1342711C1 | 70 x 27mm | ZF APL.335 | C |
| 25/6403-9 | 1342705C1 | 71 x 27mm | N.14411, ZF APL.335 | C |
| 25/6403-7 | 3230277R1 | 82 x 27mm | "LOBRO" ZF APL.1351 | B |
| 25/6403-8 | 3216691R1 | 83 x 30mm | ZF APL.1251 | D |
| 25/6403-15 | 1342708C1 | 86 x 32mm | ZF APL.345 | B |
| 25/6403-16 | 1975562C1 | 87 x 35mm | ZF APL.1552, APL.3052 | C |
| 25/6403-17 | 3223955R1 | 94 x 30mm | ZF APL.3050 | C |
| 25/6403-18 | 3224325R1 3148651R1 | 97 x 34mm | "ELBE" ZF APL.1552, APL.3052, APL.1551 | D |
| 25/6403-10 | 3133521R1 | 97 x 35mm | "LOBRO" ZF APL.3052 | A |
| 25/6403-19 | 3217467R1 | 106 x 38mm | ZF APL.3052, APL.1056 | D |
| 25/6403-20 | K965215 | 79 x 30 mm | APL.1351 | D |

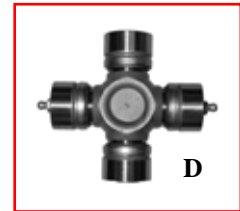
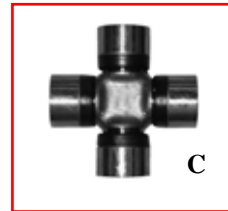
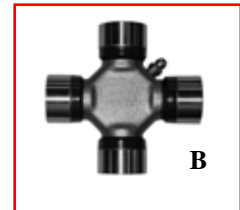
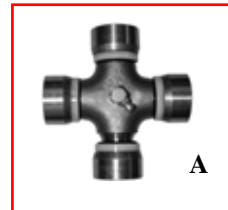

- (A) Engrasador central
centre greaser
- (B) Engrasador lateral
side greaser
- (C) Sin engrasador (sellado sin mantenimiento)
sealed long life (without greaser)
- (D) Con engrasador
Greaser on nipple

TORNILLOS Y TUERCAS (LLANTAS TRASERAS)
STUDS AND SCREWS (REAR WHEEL)

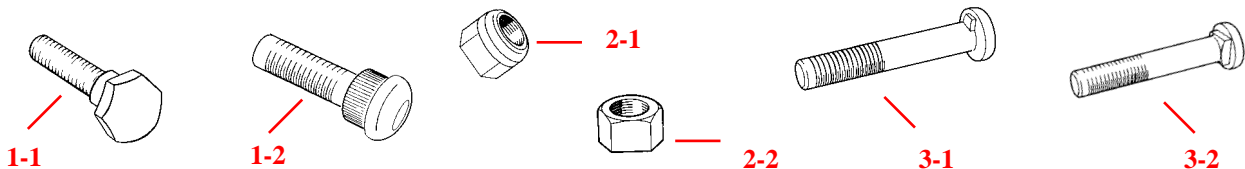

| Fig. | 1 | 2 | 3 |
|--|--|---|--|
| Tractores <i>Tractors</i> | Tornillo <i>Stud</i> | Tuerca <i>Nut</i> | Tornillo de llanta <i>Rim screw</i> |
| 275, 276, 354, 374, 384, 414, 434, 444 | 25/440-6 (3047576R2) 1-1 | 25/441-7 (3047575R2) | |
| 454, 474, 484, 485, 574, 584, 585, 674, 684, 685, 784, 785, 884, 885 | 25/440-7 (404341R3) 1-2 | 2-1 5/8" | |
| Según el montaje <i>According fitting</i> | | 25/443-3 (406953R1) 2-2 5/8" | 25/442-2 (703929R1) (Cabeza redonda/ <i>lug</i>) 3-1 |
| | | | 25/442-3 (406951R2) (Cabeza cuadrada/ <i>square</i>) 3-2 |

Las referencias originales tienen un propósito identificativo.
Nuestras piezas no son originales.

Part numbers are quoted for reference purposes only.
Our parts and accessories are not original.



RÓTULAS Y ACOPLER DE DIRECCIÓN
TIE RODS AND SOCKETS

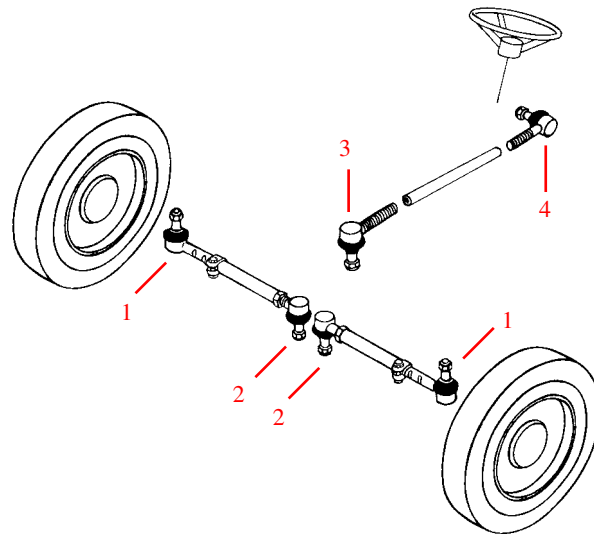
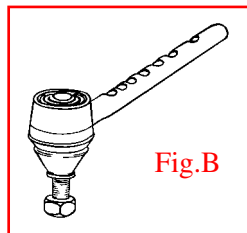
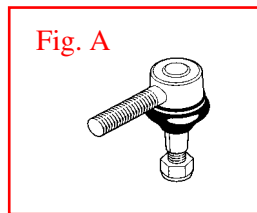

| Tractores Tractors | | OEM | Fig. | Posición | Rosca Thread | Longitud Length | Cono Cone |
|--|-----------|------------|------------|----------|-----------------|---------------------|-------------------|
| 275, 276, 354, 374, 384, 414, 434 | 25/491-14 | 3045309R91 | A | 3 | 3/8" BSP G | | 11/16 x 3/4" |
| | 25/492-14 | 3040922R92 | | 4 | 3/8" BSP D | | |
| | 25/496-14 | 3040920R92 | | 2 | 3/4" UNF D | | |
| | | 25/495-20 | 3040919R92 | B | 1 | | L = 820 Ø 3/4" |
| 385, 395, 454, 474, 475, 484, 485, 495, 574, 584, 585, 595, 674 | 25/495-21 | 3116406R2 | A | 2 | 7/8" UNF D | | 5/8" x 11/16" |
| | 25/497-11 | 3116407R2 | | | | | |
| 685, 695, 785, 795, 885, 895 (Serie XL Serie) | 25/495-21 | 3116406R2 | B | 1 (LH) | | L = 380 Ø 13/16" | |
| | 25/495-22 | 3125171R1 | | 1 (RH) | | | |
| | 25/581-7 | 3141529R91 | A | | M.30D | L = 110 | 23/26 |
| 684, 685, 695, 784, 785, 595, 884, 885, 895 | 25/495-22 | 3125171R1 | B | 1 | | L = 380 Ø 13/16" | 5/8" x 11/16" |
| | 25/497-11 | 3116407R2 | A | 2 | 7/8" UNF D | | |

ACOPLES DE DIRECCIÓN / STEERING COUPLING

Con eje central
With central axle

F22x1.5

25/495-60
(1968464C1)

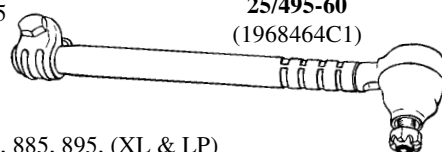

Cono / Coned
20x22

25/497-60
(1968463C1)

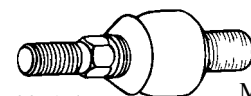

M22x1.5

M20x1.5

385, 395, 485, 585, 595, 685, 695, 785, 795, 885, 895, (XL & LP)
Con eje central APL.330, APL.335 & APL. 345
With central axle APL.330, APL.335 & APL. 345

Las referencias originales tienen un propósito identificativo.
Nuestras piezas no son originales.

Part numbers are quoted for reference purposes only.
Our parts and accessories are not original.



"THE RELIABLE SERVICE"



TRANSMISIÓN COMPLETA
FRONT AXLE SHAFT

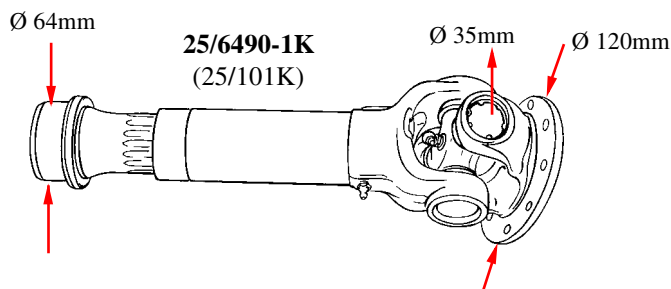

Transmisión para puentes ZF modelos
APL.1351, APL.1551, APL.1552, APL.3052
Longitud total cerrado : 345mm

Shaft to weld for offset ZF axle APL.1351,
APL.1551, APL.1552, APL.3052
Closed length : 345mm

BOMBAS HIDRÁULICAS
HYDRAULIC PUMPS (HYDR. LIFT)

25/640-26
(704330R95)

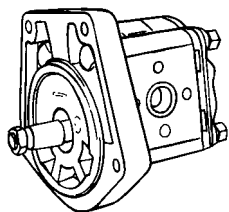

275, 276, 354, 374, 384, 414, 434, 444

25/640-15
(93835C92)

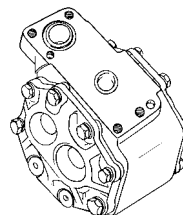

Montaje interno
Internal pump

84Hydro, 85Hydro,
385, 395, 454, 474, 475, 484, 485, 495, 574, 584, 585, 595,
674, 684, 685, 695, 784, 785, 795, 884, 885, 895 + XL,
3210, 3220, 3230, 4210, 4220, 4230, 4240

JUEGO REPARACIÓN CONVERTIDOR
TORQUE AMPLIFIER KIT

25/309-4
(534936R93)

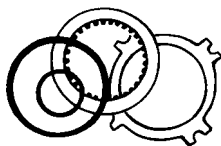

Series 74, 84, 85 & 95

JUEGO EMBRAGUE TDF
POWER TAKE OFF CLUTCH KIT

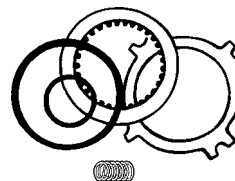

25/309-5
(534934R92)

474, 475, 574

25/309-6
(3125257R91)

884, 885, 895 (+XL)

25/309-7
(66193C91)

484, 485, 495, 584, 585, 595, 674,
684, 685, 695, 784, 785, 795 (+XL)



**EJE TRASERO
REAR AXLE PARTS**

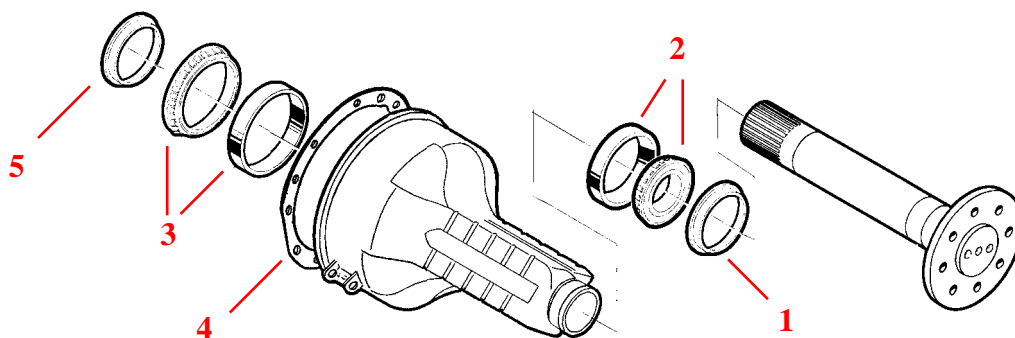

| Fig. | 1 | 2 | 3 | 4 | 5 |
|--|--|----------------------------------|----------------------------------|-------------------------------|---|
| Tractores Tractors | Retén Oil Seal | Rodamiento ext. Outer bearing | Rodamiento int. Inner bearing | Junta Gasket | Retén Oil Seal |
| 275, 276, 354 | 25/371-10 (703915R1) (63x80x10mm) Anillos en fieltro / Felt washer | 25/372-12 (3114947R91) | 25/372-13 (3114946R91) | 25/385-3 (703913R3) | |
| 374, 384, 414, 434, 444 | 25/371-11 (3069987R91) Retén / Oil Seal | | 25/372-14 (3106877R91) | | |
| 454, 484, 485, 495 | 25/371-12 (105470C1) (77,5x110x10mm) | 25/372-16 (102160H) | 25/372-17 (298188R91) | 25/385-4 (399762R3) | 25/376-7 (380200R92) (64x88,6x9,4) |
| 474, 574, 584, 585, 674, 684, 685, 784, 785, 884, 885, (+ 95 série / serie) | 25/371-13 (105471C1) (92x122x9,5mm) | 25/372-18 (384695R91) | 25/372-19 (972467R91) | | 25/376-8 (530102R91) (70x89x9) |

Las referencias originales tienen un propósito identificativo.
Nuestras piezas no son originales.

Part numbers are quoted for reference purposes only.
Our parts and accessories are not original.



**CAJA NIVELADORA
LEVELLING ROD ASSEMBLIES**

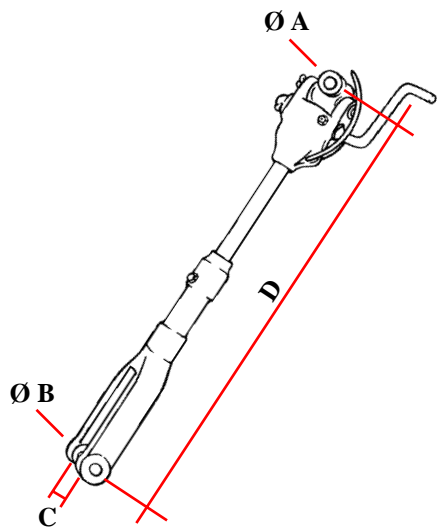

| Fig. | A | B | C | D |
|---|------------------------|--------|------|-----------|
| 25/760-25 (R443) | 16mm | 19,2mm | 38mm | 510/645mm |
| 25/760-26 (R443B) | | | 25mm | |
| 25/760-27 (R436) (Con buje / with bush) | 16mm o / or 22mm | | 44mm | 565/700mm |
| 25/760-28 (R436B) (Con buje / with bush) | | | 25mm | |

**REPUESTOS PARA HORQUILLA ORIGINAL
SPARE PARTS FOR OEM LINKAGE LEVELLING RODS**

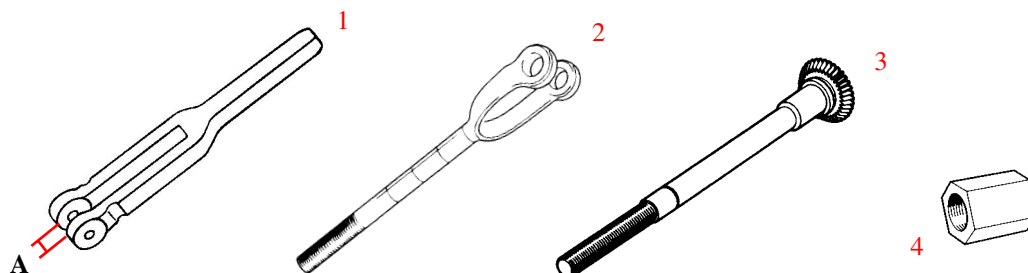

| Fig. | 1 | 2 | 3 | 4 |
|---|---|--|---|--------------------------------|
| Tractores Tractors | Horquilla Fork | Yugo Yoke | Eje Rod | Tuerca Nut |
| 454, 474, 475, 484, 485, 495, 574, 584, 585, 595, 674, 684, 685, 695, 784, 785, 795, 884, 885, 895, 985, 995 (+XL) | 25/762-21 (3121965R1) A = 38mm | 25/759-20 (527967R91) Lg. 345mm | 25/761-20 (69991C91) Lg. 368mm | 25/755-20 (527937R1) |
| | 25/762-20 (3121964R1) A = 25mm | 25/759-21 (527940R91) Lg. 435mm | 25/761-21 (69992C91) Lg. 402mm | |
| | | 25/759-22 (527948R91) Lg. 470mm | 25/761-22 (69993C91) Lg. 423mm | |
| | | | 25/761-23 (3116725R91) Lg. 462mm | |

Las referencias originales tienen un propósito identificativo.
Nuestras piezas no son originales.

Part numbers are quoted for reference purposes only.
Our parts and accessories are not original.



ESTABILIZADOR
STABILISERS & COMPONENTS

25/740-16
(R2999K)

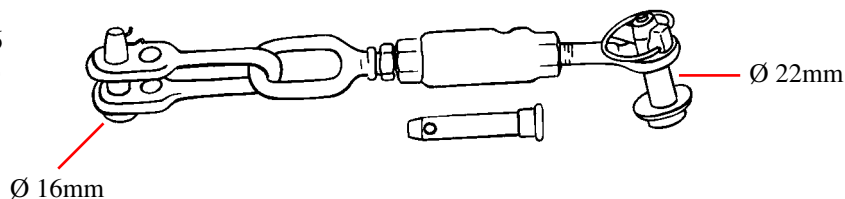

Longitud regulable de 380-445mm
Con 2 pasadores Ø 19 et Ø 22mm para uso universal
Para 275, series 74, 84, 85 & 95

*Adjustable length 380-445mm
Supplied with 2 pins Ø 19 & Ø 22mm for universal use
For 275, and 74, 84, 85 & 95 series*

PASADORES TERCER PUNTO
TOP LINK PINS

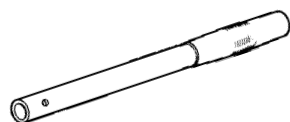

25/704-11 Cat. 1 + 2, Lg tot. 175 mm
(3137660R1)

25/704-12 Cat. 1 + 2, Lg tot. 157 mm
(528084R1)

25/704-13 Cat. 1 + 2, Lg tot. 132 mm
(528081R1)

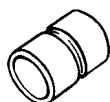

25/719-5 Buje Ø 43, larg. 35 mm

(3057362R1) *Bush Ø 43, width 35 mm*

25/719-6 Buje Ø 43, larg. 44, 5mm

(3057361R1) *Bush Ø 43, width 44.5 mm*

TERCER PUNTO
TOP LINK

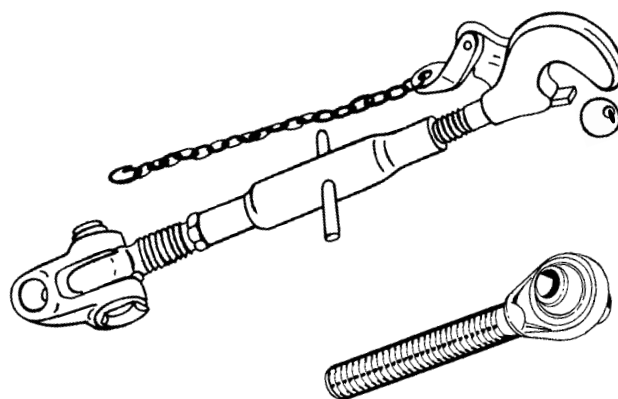

Para más información ver la gama completa
en la sección 1 del catálogo. / *For further details,
see the complete range in part 1 of the catalogue .*



ALTERNADORES Y DINAMOS
DYNAMOS & ALTERNATORS

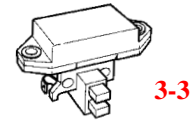
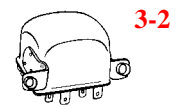
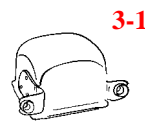
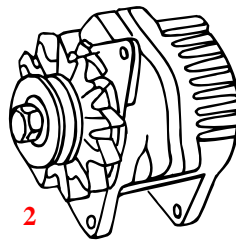
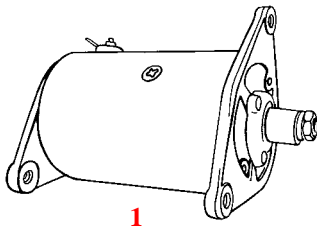

| Tractores Tractors | Alternador Alternator | Capacidad Capacity | Comentario Comment | OEM | Regulador Control box |
|---|--|-----------------------|--|-----------------------|---|
| 275, 276, 354, 414, 434, 444 | 62/910-1 (22703) 1 | 12V., 11 Amp. | Dinamo Dynamo | 3055228R91 | 62/919-1 (↔ 65) (708969R92) 3-1 |
| | 62/910-2 (22715) 1 | 12V., 22 Amp. | Dinamo Dynamo | 3112883R91 | 62/919-2 (65 ↔) (K908901) 3-2 |
| 374, 384, 444, 454, 474, 484, 584, 674, 684, 784, 884 | 62/920-4 (15/1068) 2 | 14V., 55 Amp. | Alternador (LRA 106) Alternator (LRA 106) Correa del Belt 9,5 mm | 3125132R92 | 62/919-17 (205/04034) 3-3 |
| 485, 495, 585, 595, 685, 695, 785, 795, 885, 895, 995 (+XL) 3210, 3220, 3230, 4210, 4220, 4230 | 62/920-10 (W) (15/1276) 2 | 14V., 65 Amp. | Alternador Alternator Correa del Belt 12,5 mm | 3129851R91 92292C1 | 62/919-17 (205/04034) 3-3 |

(W) Conexión eléctrica / Counter electrical connection

REPUESTOS PARA DINAMOS Y ALTERNADORES «LUCAS»
MISCELLANEOUS PARTS FOR «LUCAS» DYNAMO & ALTERNATORS

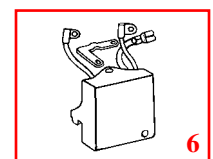
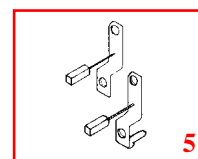
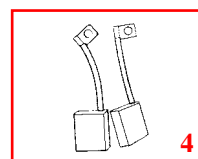
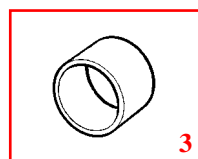
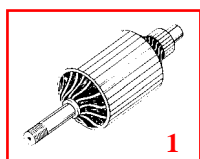

- | | | |
|----|------------------------------|--|
| 1. | 62/911-2 (UWB102) | Inducido Armature |
| 2. | 62/915-1 (UTB107) | Rodamiento Ball bearing |
| 3. | 62/914-1 (UTB110) | Casquillo Bush |
| 4. | 62/913-2 (USB104) | Juego de escobillas Brush set |
| 5. | 62/923-1 (ULB110) | Juego de escobillas para alternadores "LUCAS" Brush set for "LUCAS" alternators |
| 6. | 62/919-80 (UCB100) | Regulador para alternador "LUCAS" 34A Control box for "LUCAS" 34 A alternators |
| | 62/919-81 (UCB109) | Regulador para alternador "LUCAS" 55A Control box for "LUCAS" 55 A alternators |

para generador tipo C.40
for dynamo C.40 type

Las referencias originales tienen un propósito identificativo.
Nuestras piezas no son originales.

Part numbers are quoted for reference purposes only.
Our parts and accessories are not original.



**MOTORES DE ARRANQUE
STARTER MOTORS**

Lanceur : 11Z = 11 dientes
Fixation : Número de agujeros
L : montaje izq.

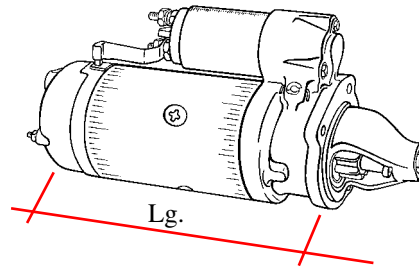

Drive : 11Z = 11 teeth
Fitting : Numbers of holes
L : left side mounting

| Tractores Tractors | REF. N° ORDER N° | Transmisión Drive ass. | Fijación Fitting | Lg. sobresaliente Prominent length | Capacidad Capacity | OEM |
|---|--|---------------------------|---------------------|---------------------------------------|-----------------------|----------------------|
| B.275, 354, 374, 384, 414, 434, 444 | 62/930-7 (27420) LRS.172 | 10Z | 3L | 258 | 12V., 3,5 KW | 3046890R91 |
| 384, 454, 474, 484, 485, 574, 584, 585, 674, 684, 685, 784, 785, 884, 885, 995, 3210, 3230, 4210, 4230, (+ series 95 Series) | 62/930-13 (27508) LRS.240 | 10Z | 3L | 235 | 12V., 2,8 KW | 537140R92 K529965 |

**REPUESTOS PARA MOTORES DE ARRANQUE "LUCAS"
SPARE PARTS FOR "LUCAS" STARTER MOTORS**

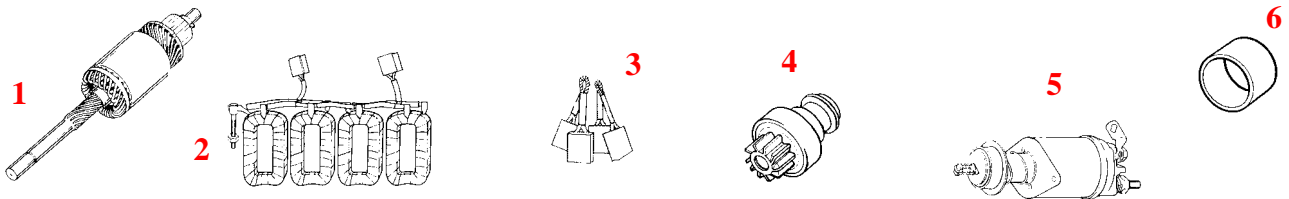

| Fig. | Motores de arranque Starter motors | 1 | 2 | 3 | 4 | 5 | 6 |
|--|---------------------------------------|--|-------------------------------------|-------------------------------------|--------------------------------------|--------------------------------------|--|
| Tractores Tractors | | Inducido Armature | Inductor Field coils | Juego de escobillas Brush set | Transmisión Drive assembly | Automatico Solenoid | Juego de 3 rodamientos 3 bearings set |
| 275, 276, 354, 374, 384, 414, 434, 444 | M.45G (26132) | | | 62/933-2 (TAB125, 705833R91) | | 62/940-4 (SRB325, 3109131R91) | 62/934-1 (TCB118, 3113029R91) |
| | M.45G (26193) | 62/931-3 (TIB113, 3047395R91) | 62/932-3 (TEB132, 3062381R91) | | 62/939-5 (TLB118, 3117750R91) | 62/940-5 (TOB153, 3062380R91) | |
| 354, 374, 384, 414, 434, 444 | M.45G/2M113 (26288, 27420) | 62/931-5 12 dent./ spl. (TIB108, 3129384R1) | | 62/939-8 (TMB120, 3114822R91) | 62/940-7 (TOB162, 3111040R91) | | |
| 454, 484, 485, 574, 584, 585, 674, 685, 784, 785, 885, 895, 985, 995 (+XL) | M.50G (26336) | 62/931-8 (TJB104 3113038R91) | 62/932-4 (TEB129, 3206527R91) | 62/933-3 (TAB118, 3118371R91) | 62/939-13 (TMB102, 3113033R91) | 62/940-11 (TOB123, 3124479R93) | |
| | M.127/2,8 (27508LRS240) | 62/931-10 (TJB112, 84059C1) | 62/932-7 (TEB144, 84058C1) | | 62/939-16 (TNB169, 84209C2) | 62/940-13 (TOB182, 84060C1) | |

Las referencias originales tienen un propósito identificativo.
Nuestras piezas no son originales.

Part numbers are quoted for reference purposes only.
Our parts and accessories are not original.

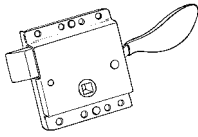
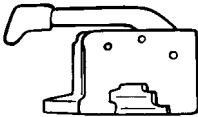
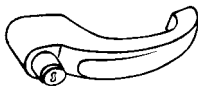
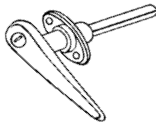

MANETAS DE LA PUERTA
CAB DOOR LOCKS & HANDLES

| | | | |
|--|-----------------------------------|-----------------------------|---|
|  | 70/4170-26 (3112460R91) | Izq./ Left | Series 74, 84 & 85 Series |
| | 70/4170-27 (3112461R91) | Drcha./ Right | |
|  | 70/4170-28 (1328552C1) | Izq./ Left | Series 85 & 95 Series Cabina "L" Cab |
| | 70/4170-29 (1328553C1) | Drcha./ Right | |
|  | 70/4170-25 (13/1443) | Izq.o Drcha./ Left or right | Cabina LP "SUPER" Cab |
| | 70/4170-30 (13/1417) | Izq.o Drcha./ Left or right | Cabina "L" Cab Series 85 & 95 Series |
|  | 70/4170-31 (3113466R91) | Izq.o Drcha./ Left or right | Series 74, 84 & 85 Series |

PINTURA
PAINT

**LA MEJOR
PINTURA**

LAQUE AMERICAINE

**THE BEST PAINT
ON THE MARKET**



64/LA.3011/L
64/LA.5044/L
64/LA.5044/SP
64/LA.2156009/L
64/LA.2156009/SP
64/LA.5042/L
64/LA.5042/SP
64/LA.8067/L
64/LA.8067/SP
64/LA.5032/L
64/LA.6014/L
64/LA.6014/SP
64/LA.5016/L
64/LA.5016/SP

Naranja / Orange - CASE
Rojo / Red - CASE
Rojo / Red - CASE
Negra semi brillante / Semi gloss black
Negra semi brillante / Semi gloss black
Rojo / Red - IH
Rojo / Red - IH
Plata / Silver - IH
Plata / Silver - IH
Rojo / Red - MAXXUM CASE-IH
Gris / Grey beige - Mac Cormick
Gris / Grey beige - Mac Cormick
Rojo / Red - Mac Cormick
Rojo / Red - Mac Cormick

(1 litro / litre)
(1 litro / litre)
(Spray)
(1 litro / litre)
(Spray)
(1 litro / litre)
(Spray)
(1 litro / litre)
(Spray)
(1 litro / litre)
(Spray)
(1 litro / litre)
(Spray)
(1 litro / litre)
(Spray)



PINTURA DE CALIDAD A UN PRECIO ATRACTIVO
QUALITY PAINT AT AN ATTRACTIVE PRICE

64/3102-40 CASE-IH Rojo / Red
64/3102-16 CASE-IH Naranja / Orange

Las referencias originales tienen un propósito identificativo.
Nuestras piezas no son originales.

Part numbers are quoted for reference purposes only.
Our parts and accessories are not original.



**AMORTIGUADORES PARA CABINA "DE LUXE"
GAS STRUTS FOR "DE LUXE" CABS**

Para más información ver la gama completa en la sección 1 del catálogo / For further details, see the complete range in part 1 of the catalogue .

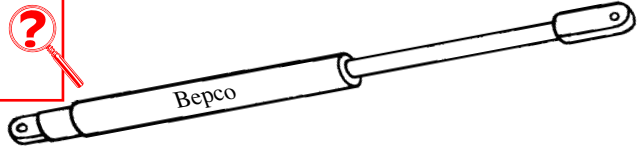

| Tractores Tractors | Parabrisas Windscreen | Puerta Door | Techo Roof | Ventana trasera Rear window |
|---|--------------------------|--|--|--|
| 485, 585, 685, 785, 885, 695, 795, 895, 995 (Cabina Kabine "XL" Cab) | | 25/872-14 (3232937R1) 278mm | 25/871-11 (3399422R3) 224mm | 25/870-15 (3234163R1) 550mm |
| 384, 484, 584, 684, 784, 884, 385, 485, 585, 685, 785, 885 (Cabina Kabine "L" Cab) | | 25/870-13 (3123040R1) 290mm | 25/871-10 (3123835R1) 255mm | 25/870-12 (3118430R1) 290mm |
| 484, 584, 684, 784, 884, 485, 585, 685, 785, 885 (Cabina Kabine "SUPER DE LUXE" Cab) | | | | 25/870-14 (3125425R1) 420mm |
| 3210, 3220, 3230, 4210, 4220, 4230, 4240 (Cabina Kabine LP Cab) | | 25/872-22 (1332420C1) 452mm | | 25/870-35 (144947A2) 450mm |

RETROVISORES/ MIRRORS

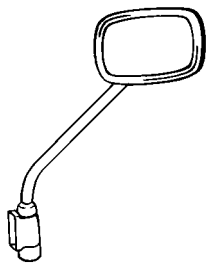

70/4172-25
(ET642
3118074R91)

Retrovisor inglés con cubeta 180x125mm y brazo con dispositivo de pliegue para obstáculos
British style mirror with retractable safety arm

70/4172-26
(10/6218E
3118077R91)

Cubeta con pinza
Mirror for above with clamp

Para más información ver la gama completa en la sección 1 del catálogo.

For further details, see the complete range in part 1 of the catalogue .

ASIENTO / SEATS



61/830-845
(SG10/UAC)

- * Acabado en plástico negro
- * Base plana y regulable de 10 a 20° con 5 posiciones
- * Suspensión vertical regulable con amortiguador hidráulico
- * Asiento con guías de ajuste
- * Respaldo con brazos
- * *Black upholstery*
- * *Height adjustment with hydraulic damper*
- * *Sliderrails for horizontal adjustment*
- * *Horizontal mounting plate with adjustment*
- * *5 positions (12° --> 20°)*
- * *Wraparound backrest*

Para más información ver la gama completa en la sección 1 del catálogo. / For further details, see the complete range in part 1 of the catalogue.

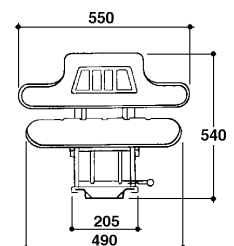
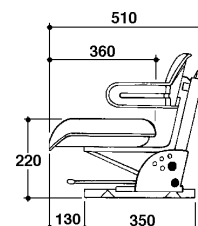

Las referencias originales tienen un propósito identificativo. Nuestras piezas no son originales.

Part numbers are quoted for reference purposes only. Our parts and accessories are not original.



ESCOBILLAS Y MOTORES DEL LIMPIA-PARABRISAS
WIPER MOTORS & BLADES

ESCOBILLAS
WIPER BLADES

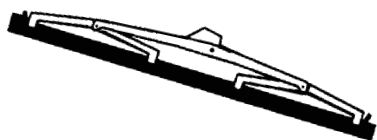

| | | |
|-----------------------------------|------------|--|
| 70/1987-9 (3113077R1) | 400/410 mm | 354, 384, 454, 484, 574, 584, 674, 684, 784 |
| 70/1987-18 (3113942R1) | 450/460 mm | 884 |
| 70/1987-20 (3234746R91) | 500/510 mm | 385, 485, 585, 685, 785, 885, (+XL) |

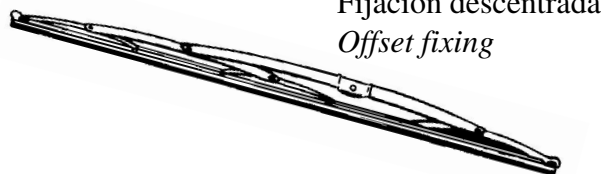

| | |
|-----------------------------------|-------------------------------------|
| 70/1987-25 (3401303R91) | Cabina XL Cab (Repl. SWF 105281) |
|-----------------------------------|-------------------------------------|

MOTORES DEL LIMPIA PARABRISAS
WIPER MOTOR

63/1980-2
(10/112-85)
63/1980-3
(10/112-110)

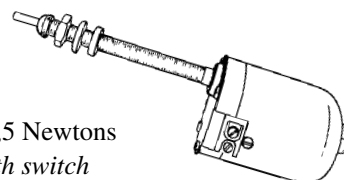
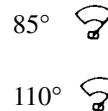

Presión / Torque : 4,5 Newtons
Con interruptor / With switch
12 Volts

CALEFACCIÓN DE CABINA
CAB HEATER

Cabine XL Cab

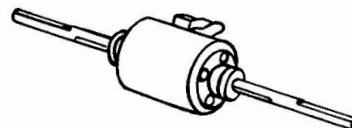

25/1988-1 - Motor / Motor
(1974779C1)

Para más información ver la gama completa en la sección 1 del catálogo.
For further details, see the complete range in part 1 of the catalogue.



GOMA PARA CRISTALES DE CABINA
GLAZING RUBBER AND DRAFT EXCLUDERS

| Ref. Ref. | Secciones (Goma negra) Sections (Black rubber) | | | | | | Secciones (Negra) Sections (Black) | | | |
|------------------------------|---|---------------------------------------|---------------------------------------|--|--------------------------------|--------------------------------|---------------------------------------|-------------------------------|-------------------------------|-------------------------------|
| | | | | | | | | | | |
| | 70/4110-9 (13/1200) (A) | 70/4110-10 (13/1206) (B) | 70/4110-11 (13/1207) (C) | 70/4111-4 (13/1201) | 70/4110-12 (13/1208) | 70/4110-13 (13/1209) | 70/4112-2 (13/1202) | 70/4112-3 (13/1203) | 70/4112-4 (13/1204) | 70/4112-5 (13/1205) |
| Tamaño cristal Glass size | 6,0mm | 4,7mm | 4,7mm | Filtro para Filler strip for A, B, C | 5,0mm | 4,0mm | | 2-5mm | 5-6mm | 6mm |
| Panel Panel | 1,2/1,6mm | 1,2/1,6mm | 2,6/3,2mm | | 2mm | 2mm | | | | |

Se vende en metros / Sold in metres

Las referencias originales tienen un propósito identificativo.
Nuestras piezas no son originales.

Part numbers are quoted for reference purposes only.
Our parts and accessories are not original.



CRISTAL DE CABINA
CAB GLASS

CABINA L / L CAB

384, 385, 395, 484, 485, 495, 584, 585, 595, 684, 685, 695, 784, 785, 795, 884, 885

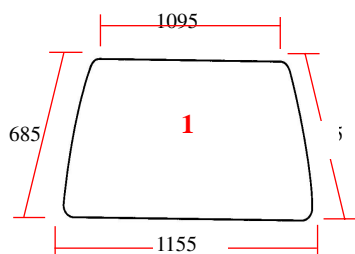
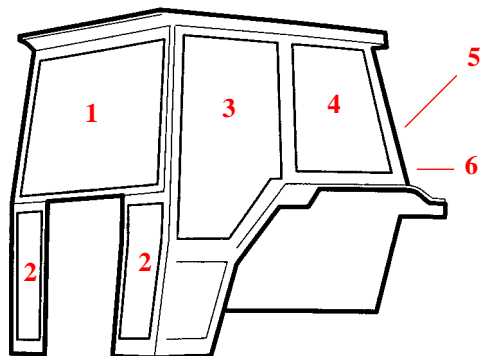

25/4000-35
(D.7000, 3113554R1)
Parabrisas
Windscreen

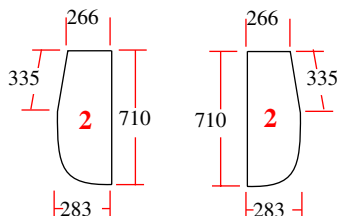

25/4012-24
(D.7001, 3113558R1)
Delantero inferior
(drcha. & izq.)
Front (RH & LH)

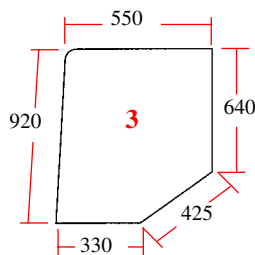

25/4020-11
(D.7002, 1500610C2)
Puerta (modelos antiguos)
Door (1st model)

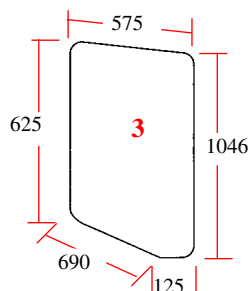

25/4020-12
(D.7008, 3114017R1)
Puerta (modelos nuevos)
Door (Last model)

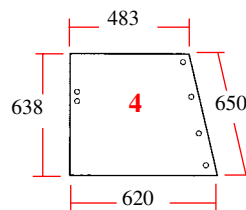

25/4047-12
(D.7003, 3123655R1)
Lateral (6 agujeros)
Side (6 holes)

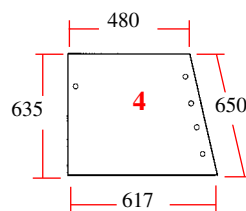

25/4047-13
(D.7006, 1328550C1)
Lateral (5 agujeros)
Side (5 holes)

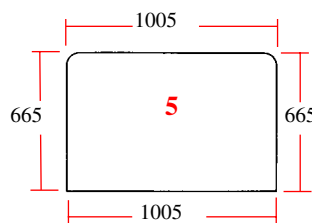

25/4072-30
(D.7004, 98604C2)
Trasero (superior)
Rear (upper)

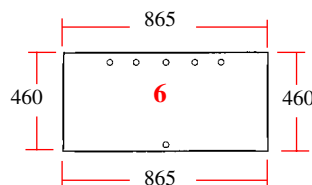

25/4073-12
(D.7005, 3118657R1)
Trasero (inferior, 6 agujeros)
Rear (lower, 6 holes)

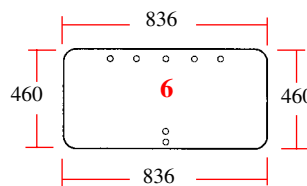

25/4073-13
(D.7007, 1328504C1)
Trasero (inferior, 7 agujero)
Rear (lower, 7 holes)

Las referencias originales tienen un propósito identificativo.
Nuestras piezas no son originales.

Part numbers are quoted for reference purposes only.
Our parts and accessories are not original.



**CRISTAL DECABINA
CAB GLASS**

CABINA XL / XL CAB

485, 585, 685, 785, 884, 885

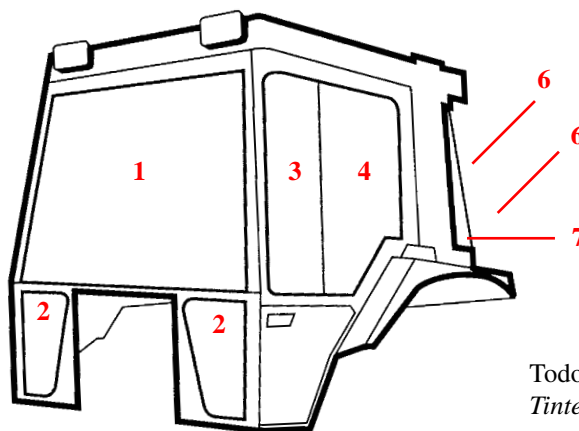

Todos los cristales son tintados
Tinted glass

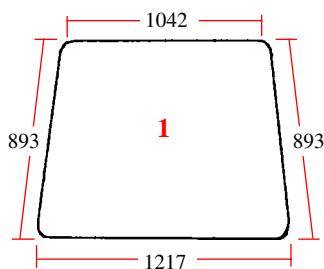

25/4000-36
(D.7010, 3233045R1)
Parabrisas
Windscreen

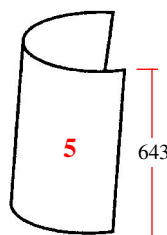

25/4086-1
(D.7016, 3233041R1)
Trasero drcha. (esquina)
Rear RH (corner)

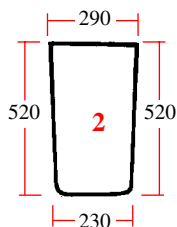

25/4012-23
(D.7011, 3233036R1)
Delantero inferior
(drcha & Izq)
Front (RH & LH)

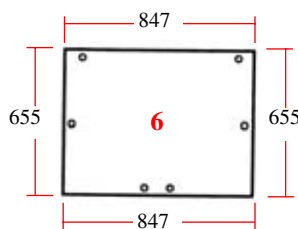

25/4072-24
(D.7017, 3233046R1)
Trasero (superior)
Rear (upper)

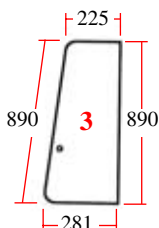

25/4026-2
(D.7013, 3233053R1)
Puerta (deslizante)
Door

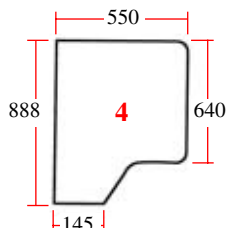

25/4027-2
(D.7014, 3233051R1)
Puerta (fjo)
Door

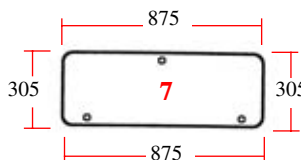

25/4073-14
(D.7018, 3233032R1)
Trasero (inferior)
Rear (lower)

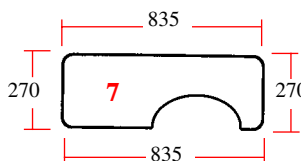

25/4073-15
(D.7019, 1500941C1)
Trasero (inferior)
Rear (lower)

Las referencias originales tienen un propósito identificativo.
Nuestras piezas no son originales.

Part numbers are quoted for reference purposes only.
Our parts and accessories are not original.



CRISTAL DE CABINA
CAB GLASS

CABINA XL / XL CAB

3210, 3220, 3230, 4210, 4220, 4230, 4240

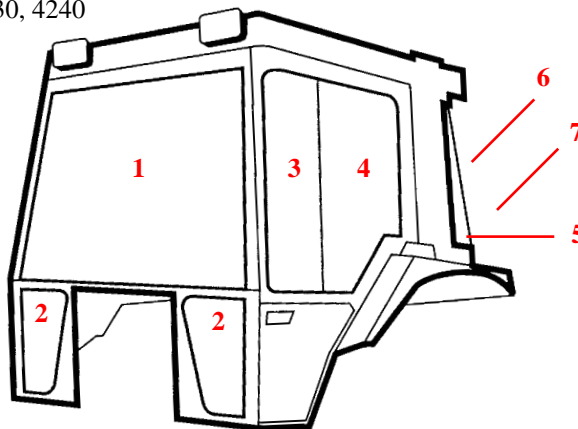

Todos los cristales son tintados
Tinted glass

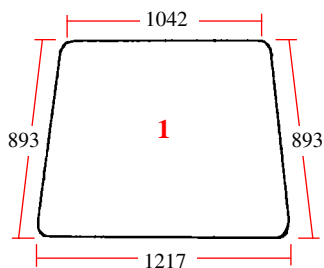

25/4000-36
(D.7010, 3233045R1)
Parabrisas
Windscreen

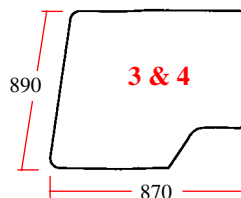

25/4020-21
(D.7098, 1975195C1)
Puerta (1 pieza)
Door (1 piece)

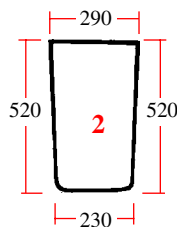

25/4012-23
(D.7011, 3233036R1)
Delantero inferior
(Drcha & Izq)
Front (RH & LH)

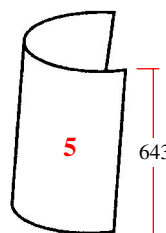

25/4086-1
(D.7016, 3233041R1)
Trasero drcha. (esquina)
Rear RH (corner)

25/4085-1
(D.7015, 3233040R1)
Trasero izq. (esquina)
Rear LH (corner)

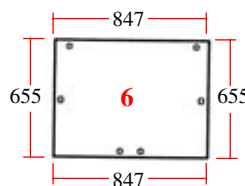

25/4072-24
(D.7017, 3233046R3)
Trasero (superior)
Rear (upper)

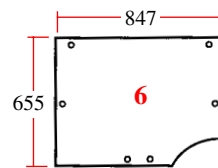

25/4072-33
(D.7099, 126317A1)
Trasero (superior) con recorte
Rear (upper) with cut out

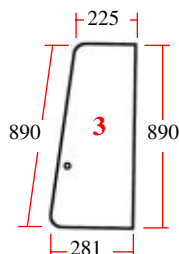

25/4026-2
(D.7013, 3233053R1)
Puerta (delantera)
Door (front)

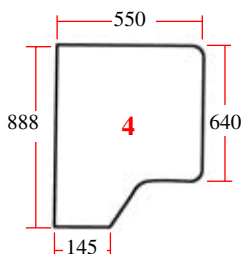

25/4027-2
(D.7014, 3233051R1)
Puerta (trasera)
Door (rear)

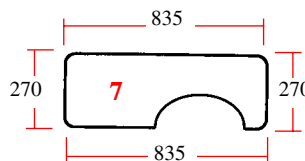

25/4073-15
(D.7019, 1500941C1)
Trasero (inferior)
Rear (lower)

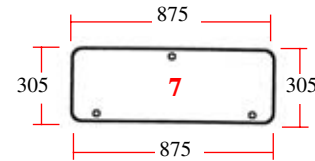

25/4073-14
(D.7018, 3233032R1)
Trasero (inferior)
Rear (lower)

Las referencias originales tienen un propósito identificativo.
Nuestras piezas no son originales.

Part numbers are quoted for reference purposes only.
Our parts and accessories are not original.



CRISTAL DE CABINA
CAB GLASS

CABINA LP / LP CAB

3210, 3220, 3230, 4210, 4220, 4230, 4240

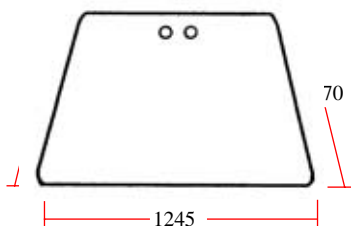
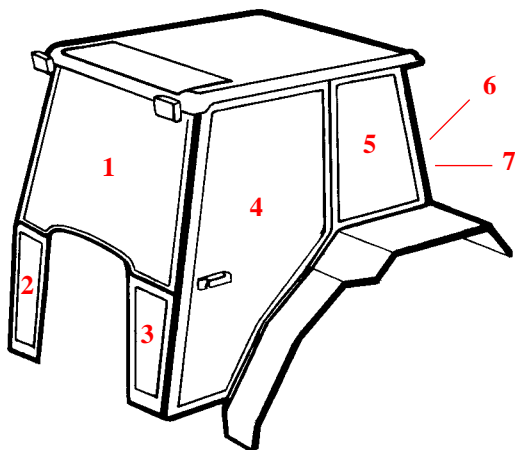

25/4000-48
(D.7090, 144768A1)
Parabrisas 2 agujeros
Windscreen 2 holes

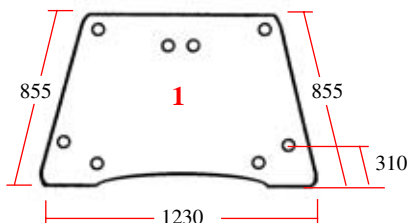

25/4004-1
(D.7091, 144986A1)
Parabrisas 8 agujeros
Windscreen 8 holes

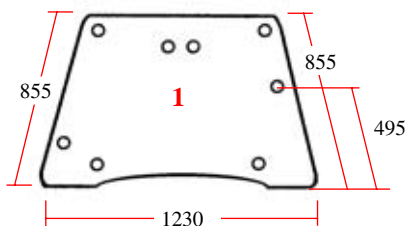

25/4004-3
(D.7091/A, 234969A1)
Parabrisas 8 agujeros
Windscreen 8 holes

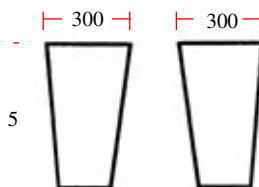

25/4012-32
(D.7092, 144730A1)
Delantero inferior
Front

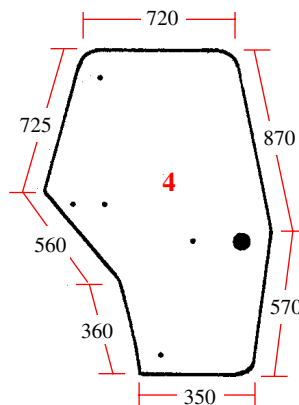

25/4038-13
(D7096, 144950A1)
Porte (Gauche)
Puerta (Izq.)

25/4039-13
(D7097, 144969A1)
Porte (Droit)
Puerta (Dcha.)

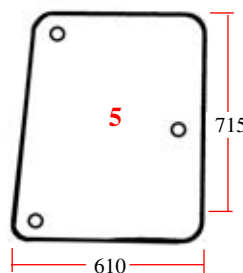

25/4047-28
(D.7093, 144759A1)
Lateral
Side

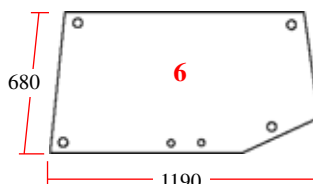

25/4072-36
(D.7094, 144794A1)
Trasero (superior)
Rear (upper)

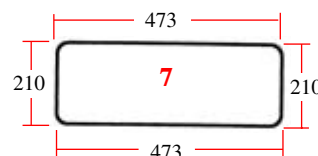

25/4073-22
(D.7095, 144731A1)
Trasero (inferior)
Rear (lower)

Las referencias originales tienen un propósito identificativo.
Nuestras piezas no son originales.

Part numbers are quoted for reference purposes only.
Our parts and accessories are not original.



**CRISTAL DE CABINA
CAB GLASS**

CABINA SEKURA AP / SEKURA AP CAB

484, 584, 684, 784, 884

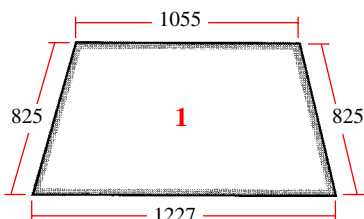
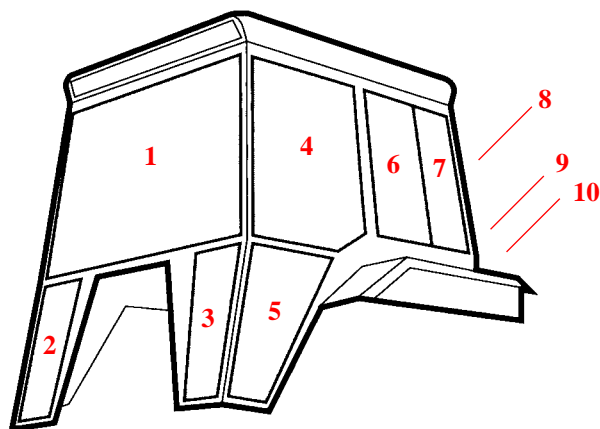

25/4002-2
(D.7040, 3125386R1)
Marco + Parabrisas
Frame + windscreen

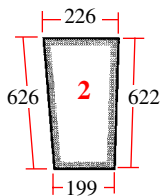

25/4015-2
(D.7042, 3125387R1)
Delantera (izq.)
Front (LH)

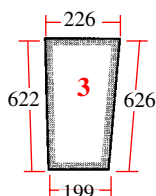

25/4016-2
(D.7041, 3125388R1)
Delantera (drcha.)
Front (RH)

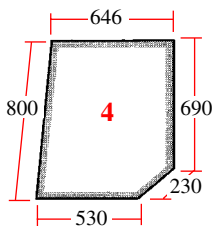

25/4035-1
(D.7044, 3125457R1)
Puerta (superior izq.)
Door (LH upper)

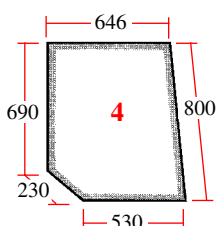

25/4034-1
(D.7043, 3125458R1)
Puerta (superior drcha.)
Door (RH upper)

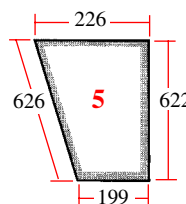

25/4037-1
(D.7046, 3125459R1)
Puerta (inferior izq.)
Door (LH lower)

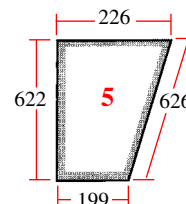

25/4036-1
(D.7045, 3125460R1)
Puerta (superior drcha.)
Door (RH lower)

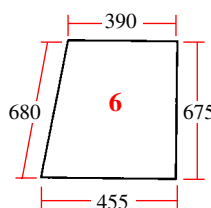

25/4041-5
(D.7048/F, 3125392R1))
Fijo (izq. o drcha.)
Side fixed (LH & RH)

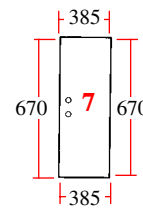

25/4040-3
(D.7048/S, 3125391R1)
Deslizante (izq. o drcha.)
Side sliding (LH & RH)

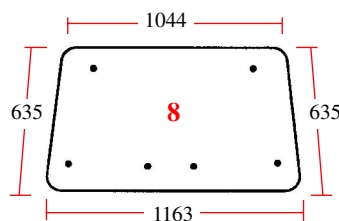

25/4072-22
(D.6772, 3125412R1)
Trasero (superior)
Rear (upper)

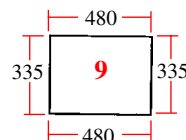

25/4075-3
(D.7050/F, 3125396R1)
Trasero (fijo)
Rear (fixed)

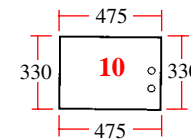

25/4074-3
(D.7050/S, 3125395R1)
Trasero (deslizante)
Rear (sliding)

Las referencias originales tienen un propósito identificativo.
Nuestras piezas no son originales.

Part numbers are quoted for reference purposes only.
Our parts and accessories are not original.



LISTA DE REFERENCIAS CRUZADAS (OEM)
CROSS REFERENCES (OEM)

| OEM OEM | REF. ANTIGUA OLD REF. | REF. n° ORDER N° | PAGINA PAGE | OEM OEM | REF. ANTIGUA OLD REF. | REF. n° ORDER N° | PAGINA PAGE |
|----------------|-----------------------|------------------|-----------------|---------------|-----------------------|------------------|-----------------------------|
| 0190601006 | 205/01001 | 62/919-15 | CIH-48 | 1401001600041 | | 25/200-306 | CIH-29 |
| 0192052005 | 205/01007 | 62/919-13 | CIH-48 | 140100160005 | | 25/221-181 | CIH-29 |
| 0250200021 | R20601 | 25/60-13 | CIH-8 | 140100160006 | | 25/212-63 | CIH-29 |
| 0331401001 | 203/01056R | 62/940-18 | CIH-50 | 144730A1 | D7092 | 25/4012-32 | CIHE-40 |
| 0331401002 | 203/01069 | 62/940-29 | CIH-50 | 144731A1 | D7095 | 25/4073-22 | CIHE-40 |
| 0331401003 | 203/01065 | 62/940-28 | CIH-50 | 144759A1 | D7093 | 25/4047-28 | CIHE-40 |
| 0331401004 | 203/01070 | 62/940-19 | CIH-50 | 144768A1 | D7090 | 25/4000-48 | CIHE-40 |
| 0331401008 | 203/01049 | 62/940-27 | CIH-50 | 144794A1 | D7094 | 25/4072-36 | CIHE-40 |
| 100546A1 | | 25/6403-13 | CIH-37, CIHE-26 | 144947A2 | | 25/870-35 | CIHE-35 |
| 102160H | 0102160H | 25/372-16 | CIHE-29 | 144986A1 | D7091 | 25/4004-1 | CIHE-40 |
| 105470C1 | 0105470C1 | 25/371-12 | CIHE-29 | 1500021C1 | 01500021C1 | 25/409-15 | CIHE-17 |
| 105471C1 | 0105471C1 | 25/371-13 | CIHE-29 | 1500491C1 | 01500491C1 | 25/177-22 | CIHE-17 |
| 1094012R91 | R1094012 | 25/131-27 | CIH-11, CIHE-11 | 1500494C92 | 01500494R91 | 25/172-16 | CIHE-16 |
| 1094015R92 | R1094015 | 25/460-14 | CIHE-23 | 1500610C2 | D7002 | 25/4020-11 | CIHE-37 |
| 1094017R92 | R1094017 | 25/460-13 | CIHE-23 | 1500626C91 | R532029 | 25/151-12 | CIHE-11 |
| 1094021R91 | 131-25 | 25/131-25 | CIHE-11 | 1500655C91 | 01500655C91 | 25/200-45 | CIHE-20 |
| 1094034R93 | R1094034 | 25/460-18 | CIHE-23 | 1500716C1 | 01500716C1 | 25/177-23 | CIHE-17 |
| 1094366R1 | 10/12498 | 63/1955-382 | CIH-20 | 1500941C1 | D7019 | 25/4073-15 | CIH-55, CIHE-38, CIHE-39 |
| 1094368R1 | 10/12821 | 63/1955-207 | CIH-20 | | | | |
| 1105717C1 | 2465 | 60/161-60 | CIH-17 | 1502155C91 | 1087/PK | 60/111-3 | CIH-14, CIHE-13 |
| 1107014144 | 258/01026 | 62/913-5 | CIH-48 | 1531489C1 | | 25/876-1 | CIH-52 |
| 11201675 | 15/1675 | 62/920-71 | CIH-48 | 1531490C1 | | 25/876-2 | CIH-52 |
| 1127014011 | 258/01073 | 62/923-5 | CIH-48 | 1532287C1 | 25/1532287 | 25/758-7 | CIH-46 |
| 114622C2 | 0114622C2 | 25/420-6 | CIHE-21 | 1532371C1 | R3399520 | 25/950-16 | CIH-23 |
| 114799A1 | 15/30412 | 62/930-52 | CIH-49 | 1532372C1 | R3405762 | 25/950-17 | CIH-23 |
| 117997 | 0117997 | 25/2830-150 | CIHE-22 | 1533880C1 | 25/1533880 | 25/1971-3 | CIH-23 |
| 126144A1 | 25/495-67 | 25/495-67 | CIH-41 | 1533899 C1 | 25/1533899 | 25/1970-3 | CIH-23 |
| 126145A1 | 25/495-68 | 25/495-68 | CIH-41 | 1535071C1 | D7065 | 25/4073-21 | CIH-56 |
| 126317A1 | D7099 | 25/4072-33 | CIHE-39 | 1535079C1 | D7064 | 25/4072-32 | CIH-56 |
| 127442A1 | D7080 | 25/4072-41 | CIH-57 | 1535088C1 | D7061 | 25/4012-29 | CIH-56 |
| 1280263C1 | | 25/872-21 | CIH-52 | 1535093C2 | D7060 | 25/4000-45 | CIH-56 |
| 1284622C2 | 25/1284622 | 25/872-11 | CIH-52 | 1535113C1 | D7062 | 25/4022-22 | CIH-56 |
| 1284636C2 | 25/1284636 | 25/870-9 | CIH-52 | 1535114C1 | D7063 | 25/4021-22 | CIH-56 |
| 1287734C92 | | 25/410-12 | CIH-30, CIHE-21 | 1546817C2 | D7075 | 25/4038-8 | CIH-57 |
| 1287843C92 | | 25/410-15 | CIH-30, CIHE-21 | 1546818C2 | D7077 | 25/4039-8 | CIH-57 |
| 1288228C1 | | 25/411-13 | CIH-30, CIHE-21 | 15943DA | 476-12 | 25/476-12 | CIHE-22 |
| 1288229C1 | | 25/411-12 | CIH-30, CIHE-21 | 189447A2 | 25/71-33+25/72-33 | 25/870-33 | CIH-52 |
| 13/1417 | 13/1417 | 70/4170-30 | CIHE-34 | 1962381C1 | 01962381C1 | 25/177-20 | CIHE-17 |
| 131003810 | 131003810 | 25/200-110 | CIHE-20 | 1964054C1 | 229000112 | 25/200-55 | CIH-25, CIH-26 |
| 13200002000021 | | 25/200-305 | CIH-28 | 1964055C1 | 229000111 | 25/200-116 | CIH-27 |
| 1320000200041 | | 25/221-179 | CIH-28 | 1964056C2 | 230001114 | 25/200-56 | CIH-26 |
| 132000020005 | | 25/212-162 | CIH-28 | 1964057C1 | 231002314 | 25/200-60 | CIH-27 |
| 13200009075 | | 62/930-43 | CIH-49 | 1964058C2 | 235000310 | 25/200-120 | CIH-28 |
| 1328276C1 | 25/1328276 | 60/240-43 | CIH-14 | 1964059C1 | 235000410 | 25/200-121 | CIH-28 |
| 1328504C1 | D7007 | 25/4073-13 | CIHE-37 | 1964060C2 | 235000310 | 25/200-120 | CIH-28 |
| 1328550C1 | D7006 | 25/4047-13 | CIHE-37 | 1964061C1 | 235000410 | 25/200-121 | CIH-28 |
| 1328552C1 | 01328552C1 | 70/4170-28 | CIHE-34 | 1964088C1 | 328002312 | 25/212-32 | CIH-26 |
| 1328553C1 | 01328553C1 | 70/4170-29 | CIHE-34 | 1964089C1 | 331007311 | 25/212-36 | CIH-27 |
| 1328655C91 | R1328655 | 69/565-22 | CIH-43 | 1964090C1 | 335007911 | 25/212-38 | CIH-28 |
| 1329020C2 | 03132737R93 | 60/97-12 | CIH-14, CIHE-13 | 1964154C1 | 329000111 | 25/221-116 | CIH-27 |
| 1329039C1 | 25/1329039 | 60/156-3 | CIH-14 | 1964221C1 | 231002313 | 25/200-118 | CIH-27 |
| 1329196C1 | | 25/1-55 | CIH-3, CIHE-3 | 1964222C2 | 331007317 | 25/212-35 | CIH-27 |
| 1330876C1 | D7073 | 25/4011-9 | CIH-57 | 1964235C1 | | 25/6408-7 | CIH-34, CIHE-25 |
| 1330877C1 | D7072 | 25/4011-8 | CIH-57 | 1964853C1 | 25/1964583 | 25/1970-4 | CIH-23 |
| 1330902C1 | D7079 | 25/4047-35 | CIH-57 | 1964989 C1 | 25/1964989 | 25/1971-4 | CIH-23 |
| 1330903C1 | D7078 | 25/4047-34 | CIH-57 | 1965995C91 | 25/3140173 | 25/740-20 | CIH-47 |
| 1330904C1 | D7081 | 25/4072-40 | CIH-57 | 1966557C1 | | 25/231-142 | CIH-28 |
| 1330930C1 | D7074 | 25/4038-7 | CIH-57 | 1966618C1 | | 25/231-143 | CIH-28 |
| 1330931C1 | D7076 | 25/4039-7 | CIH-57 | 1967011C1 | 25/3136813 | 25/72-49 | CIH-8, CIHE-8 |
| 1332420C1 | | 25/872-22 | CIH-52, CIHE-35 | 1967013C1 | 25/3136817 | 25/72-50 | CIH-8 |
| 1333291C1 | 25/1333291 | 25/181-22 | CIH-20 | 1967014C1 | 25/3136799 | 25/71-49 | CIH-8, CIHE-8 |
| 133736C1 | 0530144R92 | 60/240-42 | CIH-14 | 1968463C1 | R1968463C1 | 25/497-60 | CIH-41, CIHE-27 |
| 1342705C1 | | 25/6403-9 | CIH-37, CIHE-26 | 1968464C1 | R1968464C1 | 25/495-60 | CIH-41, CIHE-27 |
| 1342708C1 | | 25/6403-15 | CIH-37, CIHE-26 | 1970820C1 | 01970820C1 | 25/177-21 | CIHE-17 |
| 1342710C1 | | 25/6404-1 | CIH-34, CIHE-25 | 1971050C1 | 0401992R3 | 25/324-4 | CIHE-17 |
| 1342711C1 | | 25/6403-14 | CIH-37, CIHE-26 | 1971138C1 | | 25/410-16 | CIHE-21 |
| 1342712C1 | | 25/6405-2 | CIH-34, CIHE-25 | 1971235C2 | | 25/870-31 | CIH-52 |
| 1342713C1 | | 25/6405-1 | CIH-34, CIHE-25 | 1971728C1 | 25/1971728 | 60/641-16 | CIH-14 |
| 1342716C1 | | 25/6405-9 | CIH-34, CIHE-25 | 1974779C1 | | 25/1988-1 | CIH-53, CIHE-36 |
| 1342717C1 | | 25/6405-8 | CIH-34, CIHE-25 | 1975195C1 | D7098 | 25/4020-21 | CIHE-39 |
| 1342719C1 | 25/1342719 | 25/6403-8 | CIHE-26 | 1975562C1 | 25/1975562C1 | 25/6403-16 | CIH-37, CIHE-26 |
| 1343825C1 | | 25/870-32 | CIH-52 | 1976934C1 | 51759 | 60/240-70 | CIH-14 |
| 135506A2 | 25/135506A1 | 25/200-56K | CIH-26 | 1981934C1 | D7082 | 25/4073-36 | CIH-57 |
| | | | | 1984811C1 | | 25/200-308 | CIH-28 |

Las referencias originales tienen un propósito identificativo.
Nuestras piezas no son originales.

Part numbers are quoted for reference purposes only.
Our parts and accessories are not original.



"THE RELIABLE SERVICE"



LISTA DE REFERENCIAS CRUZADAS (OEM)
CROSS REFERENCES (OEM)

| OEM OEM | REF. ANTIGUA OLD REF. | REF. n° ORDER N° | PAGINA PAGE | OEM OEM | REF. ANTIGUA OLD REF. | REF. n° ORDER N° | PAGINA PAGE |
|------------|-----------------------|------------------|-----------------|-----------------|-----------------------|------------------|------------------------------|
| 1984812C1 | | 25/221-184 | CIH-28 | 3055129R21(x1) | 25/3055129(x1) | | |
| 1986961C1 | R1328655 | 69/565-22 | CIH-43 | +3055130R21(x3) | +25/3055130(x3) | 25/2-23 | CIH-3, CIHE-3 |
| 1995034C1 | | 25/303-30 | CIH-31 | 3055129R2 (x1) | 25/3055129(x1) | | |
| 1999625C2 | D7084 | 25/4029-4 | CIH-57 | +3055130R21(x4) | +25/3055130(x4) | 25/2-24 | CIH-3, CIHE-3 |
| 1999626C2 | D7083 | 25/4025-4 | CIH-57 | 3055129R21(x1) | 25/3055129(x1) | | |
| 199976066 | | 25/870-34 | CIH-52 | +3055130R21(x6) | +25/3055130(x6) | 25/2-26 | CIH-3, CIHE-3 |
| 2004004044 | 220/01001 | 62/931-17 | CIH-50 | 3055160R3 | 25/3218615 | 25/75-48 | CIH-8 |
| 2004004112 | 220/01055A | 62/931-12 | CIH-50 | 3055161R91 | 25/3055161 | 25/75-49 | CIH-8, CIHE-8 |
| 2006209301 | 224/01061 | 62/939-28 | CIH-50 | 3055215R3 | 25/3055215-R1 | 25/17-11 | CIH-3, CIHE-3 |
| 2006209302 | 224/01058 | 62/939-32 | CIH-50 | 3055228R91 | LU22703/N | 62/910-10 | CIHE-32 |
| 2006209303 | 224/01134 | 62/939-35 | CIH-50 | 3055229R92 | 189(IH) | 60/97-11 | CIH-14 |
| 2006209304 | 224/01150 | 62/939-30 | CIH-50 | 3055238R92 | R3055238 | 25/186-6 | CIH-12, CIHE-8 |
| 2006209436 | 224/01126 | 62/939-29 | CIH-50 | 3055285R94 | R3055285KT | 25/131-28 | CIH-11, CIHE-11 |
| 2007014052 | 258/01056B | 62/933-8 | CIH-50 | 3055304R92 | R3055304 | 25/143-30 | CIH-12 |
| 2007014056 | 258/01057 | 62/933-18 | CIH-50 | 3055351R91 | 25/3055351 | 25/3-24 | CIH-3, CIHE-3 |
| 2007014057 | 258/01059 | 62/933-17 | CIH-50 | 3055351R91 | 25/3055351 | 25/3-25 | CIH-3, CIHE-3 |
| 205/04034 | 205/04034 | 62/919-17 | CIHE-32 | 3055351R91 | 25/3055351 | 25/3-26 | CIH-3, CIHE-3 |
| 223807A1 | | 25/200-307 | CIH-29 | 3055351R91 (x3) | 25/3055351 (x3) | 25/3-23 | CIH-3, CIHE-3 |
| 226823A1 | | 25/303-30 | CIH-31 | 3055426R91 | R3055426 | 25/117-56 | CIH-10 |
| 234969A1 | D7091/A | 25/4004-3 | CIHE-40 | 3055428R92 | R3055428 | 25/117-57 | CIH-10 |
| 298188R91 | 0298188R91 | 25/372-17 | CIHE-29 | 3055715R1 | 25/3055715 | 25/144-24 | CIH-12, CIHE-10 |
| 3040152R92 | R357111K | 25/421-16 | CIH-30, CIHE-21 | 3055987R93 | 25/3055987 | 25/75-50 | CIH-8 |
| 3040361R1 | 03040361R1 | 25/42-21 | CIHE-7 | 3056928R1 | 1007 | 60/111-32 | CIH-14 |
| 3040412R91 | 03040412R91 | 25/221-39 | CIHE-18 | 3057051R1 | 25/3057051 | 25/47-16 | CIH-32 |
| 3040871R91 | 0434250056 | 25/117-51 | CIHE-9 | 3057057R91 | 25/3057057 | 25/461-19 | CIH-33 |
| 3040919R92 | 25/3040919 | 25/495-20 | CIHE-27 | 3057058R91 | 25/3057058 | 25/479-15 | CIH-32 |
| 3040920R92 | 25/3040920 | 25/496-14 | CIHE-27 | 3057064R1 | 25/3057064 | 25/486-25 | CIH-36 |
| 3040921R11 | 25/3045309 | 25/491-14 | CIHE-27 | 3057150R92 | 1880096206 | 25/200-47 | CIH-26 |
| 3040922R92 | 25/3040922 | 25/492-14 | CIHE-27 | 3057151R92 | 186260101 | 25/221-114 | CIH-26 |
| 3041249R92 | | 25/70-33 | CIHE-8 | 3057151R92 | R3057151 | 25/221-114E | CIH-26 |
| 3042303R92 | 03042303R92 | 25/143-15 | CIHE-11 | 3057159R92 | | 25/514-25 | CIH-36 |
| 3042414R1 | 03042414R1 | 25/153-25 | CIHE-12 | 3057361R1 | 25/3057361 | 25/719-6 | CIH-47, CIHE-31 |
| 3043283R92 | 111 | 60/96-1 | CIHE-13 | 3057362R1 | 25/3057362 | 25/719-5 | CIH-47, CIHE-31 |
| 3043611R1 | 03043611R1 | 25/28-12 | CIHE-3 | 3057428R1 | 25/3057428 | 25/154-34 | CIH-13 |
| 3043825R1 | 03043825R1 | 25/43-21 | CIHE-7 | 3057564R91 | 25/3057564 | 25/1918-9 | CIH-20 |
| 3043872R91 | 463-13 | 25/463-13 | CIHE-23 | 3057565R91 | 25/3057565 | 25/1918-20 | CIH-20 |
| 3044009R1 | 03044009R1 | 25/154-27 | CIHE-12 | 3057566R91 | 25/3057566 | 25/1912-25 | CIH-21 |
| 3044239R1 | 03044239R1 | 25/44-13 | CIHE-7 | 3057567R91 | 25/3057567 | 25/1912-26 | CIH-21 |
| 3044240R1 | 03044240R1 | 25/45-13 | CIHE-7 | 3057575R91 | 25/3057575 | 25/180-7 | CIH-12, CIHE-8 |
| 3044479R94 | R3044479K | 25/31-44 | CIHE-4 | 3057633R91 | 25/3057633 | 25/958-1 | CIH-23 |
| 3044481R3 | 03444481R3 | 25/35-44 | CIHE-4, CIHE-5 | 3057998R91 | 10/343B | 25/950-11 | CIH-23 |
| 3044486R3 | 03044486R3 | 25/33-44 | CIHE-4, CIHE-5 | 3058003R1 | | 25/65-10 | CIH-19 |
| 3044492R1 | 03044492R1 | 25/41-14 | CIHE-7 | 3058207R92 | R3058207 | 25/492-16 | CIH-39 |
| 3044493R2 | 03044493R2 | 25/41-15 | CIHE-7 | 3058208R91 | R3058208 | 25/491-15 | CIH-39 |
| 3044506R93 | 1087/PK | 60/111-3 | CIH-14, CIHE-13 | 3058210R91 | R3058210 | 25/491-16 | CIH-39 |
| 3045309R91 | 25/3045309 | 25/491-14 | CIHE-27 | 3058213R91 | R3058213 | 25/495-23 | CIH-39 |
| 3046890R91 | 15/00208IH | 62/930-7 | CIHE-33 | 3058214R91 | R3058214 | 25/497-12 | CIH-39 |
| 3047395R91 | 54E251/818 | 62/931-3 | CIHE-33 | 3058222R92 | | 25/530-25 | CIH-36 |
| 3047573R1 | 03047573R1 | 25/446-9 | CIHE-23 | 3058229R92 | | 25/535-25 | CIH-36 |
| 3047575R2 | 03047575R2 | 25/441-7 | CIHE-26 | 3058242R91 | R3058242 | 25/1919-10 | CIH-20 |
| 3047576R2 | 03047576R2 | 25/440-6 | CIHE-26 | 3058245R91 | R3058245 | 25/1913-21 | CIH-21 |
| 3047747R93 | 03047747R93 | 25/200-51 | CIHE-19 | 3058254R1 | R3058254 | 25/440-8 | CIH-37 |
| 3048523R1 | 03048523R1 | 25/33-42 | CIHE-4, CIHE-5 | 3058286R93 | R3058286 | 25/177-24 | CIH-24 |
| 3048528R91 | 03048528R91 | 25/200-40 | CIHE-19 | 3058287R94 | R3058287 | 25/177-25 | CIH-24 |
| 3048529R91 | 03048529R91 | 25/221-40 | CIHE-19 | 3058344R91 | HB47/SA | 69/7600-5 | CIH-45 |
| 3048589R91 | 03048589R91 | 25/200-42 | CIHE-19 | 3058404R93 | R3058404 | 25/212-13 | CIH-26 |
| 3048590R91 | 03048590R91 | 25/221-42 | CIHE-19 | 3058405R93 | R3058405 | 25/221-115 | CIH-26 |
| 3051138R92 | 25/71-100 | 25/71-100 | CIH-8 | 3058676R91 | 1861259101 | 25/221-112 | CIH-25 |
| 3051140R92 | 25/71-101 | 25/71-101 | CIH-8 | 3058676R91 | R3058676 | 25/221-112E | CIH-25 |
| 3051142R92 | 25/71-102 | 25/71-102 | CIH-8 | 3059187R1 | R3059187 | 25/1919-9 | CIH-20 |
| 3051144R92 | 25/3051144 | 25/71-94 | CIH-8 | 3059214R94 | 1861331106 | 25/221-47 | CIH-26 |
| 3051146R92 | 25/71-103 | 25/71-103 | CIH-8 | 3059214R94 | R3059214 | 25/221-47E | CIH-26 |
| 3051148R92 | 25/3051148 | 25/71-95 | CIH-8 | 3059262R92 | 25/3059262 | 25/34-60 | CIH-4, CIH-6, CIHE-4, CIHE-6 |
| 3051192R1 | 10/12814 | 63/1955-245 | CIH-20 | | | | |
| 3052183R93 | R3052183K | 25/131-56 | CIH-11 | 3059432R1 | 25/3059432 | 25/581-3 | CIH-40 |
| 3053400R92 | 25/3053400 | 25/1920-2 | CIH-24 | 3059433R1 | 25/3059433 | 25/581-4 | CIH-40 |
| 3054300R93 | R3054300 | 69/565-19 | CIH-43 | 3059475R91 | 25/3059475 | 25/477-15 | CIH-32 |
| 3054380R91 | 1862001101 | 25/221-123 | CIH-25 | 3059676R91 | R3059676 | 25/143-17 | CIH-12, CIHE-11 |
| 3054388R91 | HB47/SAC | 69/7600-6 | CIH-45 | 3059907R91 | HB47/DA | 69/7600-7 | CIH-45 |
| 3054716R91 | R20601 | 25/60-13 | CIH-8 | 3059921R1 | | 25/164-17 | CIH-19 |
| 3055022R1 | 25/3055022 | 25/41-16 | CIH-7, CIHE-7 | 3062380R91 | LU76458 | 62/940-5 | CIHE-33 |
| 3055055R2 | 25/3055055 | 25/42-23 | CIH-7, CIHE-7 | 3062381R91 | 272E394 | 62/932-3 | CIHE-33 |
| 3055056R2 | 25/3055056 | 25/43-23 | CIH-7, CIHE-7 | 3062712R94 | 03062712R94 | 25/200-41 | CIHE-18 |
| 3055060R1 | 25/3055060 | 25/45-15 | CIH-7, CIHE-7 | 3062713R91 | 03062713R91 | 25/221-41 | CIHE-18 |

Las referencias originales tienen un propósito identificativo.
Nuestras piezas no son originales.

Part numbers are quoted for reference purposes only.
Our parts and accessories are not original.



LISTA DE REFERENCIAS CRUZADAS (OEM)
CROSS REFERENCES (OEM)

| OEM OEM | REF. ANTIGUA OLD REF. | REF. n° ORDER N° | PAGINA PAGE |
|------------|-----------------------|------------------|------------------|
| 3064170R91 | R/G250069 | 25/420-16 | CIH-30, CIHE-21 |
| 3065127R1 | 141-9 | 25/141-9 | CIHE-11 |
| 3065129R1 | 03065129R1 | 25/153-27 | CIHE-12 |
| 3065130R1 | | 25/153-26 | CIHE-12 |
| 3065132R92 | R703820 | 25/130-25 | CIHE-11 |
| 3066610R92 | | 25/101-22 | CIHE-10 |
| 3067300R92 | 03067300R92 | 25/200-43 | CIHE-18, CIHE-19 |
| 3069460R91 | R3134496K | 25/421-17 | CIH-30 |
| 3069610R1 | 03069610R1 | 25/112-1 | CIH-14, CIHE-14 |
| 3069767R1 | 25/3069767 | 25/74-25 | CIHE-8 |
| 3069987R91 | 03069987R91 | 25/371-11 | CIHE-29 |
| 3070055R91 | 479-13 | 25/479-13 | CIHE-22 |
| 3070546R91 | 03070546R91 | 25/3-21 | CIHE-3 |
| 3070635R91 | 03070635R91 | 25/231-10 | CIHE-18, CIHE-19 |
| 3072092R91 | 03072092R91 | 25/13-14 | CIHE-3 |
| 3072947R91 | 03072947R91 | 25/181-17 | CIHE-16 |
| 3074756R1 | R528084 | 25/704-12 | CIHE-31 |
| 3074827R91 | 03074827R91 | 25/221-43 | CIHE-18, CIHE-19 |
| 3076115R1 | 10/12620 | 63/1955-410 | CIH-20 |
| 3106877R91 | 03106877R91 | 25/372-14 | CIHE-29 |
| 3108650R91 | 03108650R91 | 25/11-16 | CIHE-3 |
| 3108790R91 | 03108790R91 | 25/221-51 | CIHE-19 |
| 3108790R91 | 25/3108790 | 25/221-51E | CIHE-19 |
| 3109131R91 | LU76703 | 62/940-4 | CIHE-33 |
| 3109792R92 | 03109792R92 | 25/165-30 | CIHE-15 |
| 3110452R91 | 111 | 60/96-1 | CIHE-13 |
| 3110995R91 | | 25/1-54 | CIHE-3 |
| 3111040R91 | LU76796 | 62/940-7 | CIHE-33 |
| 3111424R91 | 03111424R91 | 25/151-11 | CIHE-11 |
| 3112067R1 | 03112067R1 | 25/153-28 | CIHE-12 |
| 3112460R91 | 03112460R91 | 70/4170-26 | CIHE-34 |
| 3112461R91 | 03112461R91 | 70/4170-27 | CIHE-34 |
| 3112805R91 | 03112805R91 | 25/60-6 | CIHE-10 |
| 3112883R91 | LU227115 | 62/910-2 | CIHE-32 |
| 3113029R91 | 54E243/853 | 62/934-1 | CIHE-33 |
| 3113033R91 | 03113033R91 | 62/939-13 | CIHE-33 |
| 3113038R91 | 03113038R91 | 62/931-8 | CIHE-33 |
| 3113077R1 | 10/3223 | 70/1987-9 | CIH-53, CIHE-36 |
| 3113466R91 | 13/1414 | 70/4170-31 | CIHE-34 |
| 3113554R1 | D7000 | 25/4000-35 | CIHE-37 |
| 3113558R1 | D7001 | 25/4012-24 | CIHE-37 |
| 3113942R1 | 10/3225 | 70/1987-18 | CIH-53, CIHE-36 |
| 3114017R1 | D7008 | 25/4020-12 | CIHE-37 |
| 3114166R91 | 03114166R91 | 25/449-12 | CIHE-24 |
| 3114775R91 | 03114775R91 | 25/34-42 | CIHE-4, CIHE-6 |
| 3114778R91 | 03114778R91 | 25/34-44 | CIHE-4, CIHE-6 |
| 3114822R91 | 03114822R91 | 62/939-8 | CIHE-33 |
| 3114946R91 | 03114946R91 | 25/372-13 | CIHE-29 |
| 3114947R91 | 25/3114947 | 25/372-12 | CIH-31, CIHE-29 |
| 3115569R2 | 03115569R2 | 60/162-16 | CIHE-13 |
| 3116406R2 | R3116406 | 25/495-21 | CIHE-27 |
| 3116406R3 | R3116406 | 25/495-21 | CIHE-27 |
| 3116407R2 | R3116407 | 25/497-11 | CIHE-27 |
| 3116407R3 | R3116407 | 25/497-11 | CIHE-27 |
| 3116609R92 | 03116609R92 | 60/97-9 | CIHE-13 |
| 3116664R2 | | 25/154-30 | CIHE-12 |
| 3116665R2 | | 25/153-30 | CIHE-12 |
| 3116725R91 | 03116725R91 | 25/761-23 | CIHE-30 |
| 3117750R91 | 292E124 | 62/939-5 | CIHE-33 |
| 3118074R91 | ET642 | 70/4172-25 | CIHE-35 |
| 3118077R91 | 10/6218E | 70/4172-26 | CIHE-35 |
| 3118119R1 | | 60/97-27 | CIHE-13 |
| 3118124R91 | 25/71-47 | 25/71-47 | CIHE-8 |
| 3118125R91 | 25/130-26 | 25/130-26 | CIHE-11 |
| 3118126R91 | 25/131-26 | 25/131-26 | CIHE-11 |
| 3118127R1 | 25/143-16 | 25/143-16 | CIHE-11 |
| 3118128R91 | 25/11-17 | 25/11-17 | CIHE-3 |
| 3118131R1 | 25/34-61 | 25/34-61 | CIHE-4, CIHE-6 |
| 3118132R1 | 25/43-22 | 25/43-22 | CIHE-7 |
| 3118133R1 | 25/45-14 | 25/45-14 | CIHE-7 |
| 3118134R1 | 25/44-14 | 25/44-14 | CIHE-7 |
| 3118135R1 | P85042 | 25/3-22 | CIHE-3 |
| 3118150R1 | 25/2-22 | 25/2-22 | CIHE-3 |
| 3118169R91 | P85719 | 25/1-3 | CIHE-3 |

| OEM OEM | REF. ANTIGUA OLD REF. | REF. n° ORDER N° | PAGINA PAGE |
|----------------|-----------------------|------------------|-----------------|
| 3118173R1 | 25/73-47 | 25/73-47 | CIHE-8 |
| 3118179R1 | 25/47-5 | 25/47-5 | CIHE-7 |
| 3118186R1 | 25/74-26 | 25/74-26 | CIHE-8 |
| 3118234R91 | 25/100-23 | 25/100-23 | CIHE-10 |
| 3118371R91 | 54E259/517 | 62/933-3 | CIHE-33 |
| 3118430R1 | 03118430R1 | 25/870-12 | CIHE-35 |
| 3118657R1 | D7005 | 25/4073-12 | CIHE-37 |
| 3119716R91 | R3119716 | 63/950-2 | CIHE-17 |
| 3119778R92 | R703820 | 25/130-25 | CIHE-11 |
| 3120516R91 | 25/72-47 | 25/72-47 | CIHE-8 |
| 3121089R91 | R3121089 | 25/1918-3 | CIH-20 |
| 3121261R91 | 03121261R91 | 25/470-66 | CIHE-22 |
| 3121270R91 | 03121270R91 | 25/470-67 | CIHE-22 |
| 3121425R91 | 03121425R91 | 25/449-13 | CIHE-24 |
| 3121506R92 | 03121506R92 | 25/221-44 | CIHE-20 |
| 3121507R92 | 03121507R92 | 25/221-45 | CIHE-20 |
| 3121964R1 | 03121964R1 | 25/762-20 | CIH-46, CIHE-30 |
| 3121965R1 | 03121965R1 | 25/762-21 | CIH-46, CIHE-30 |
| 3123040R1 | 03123040R1 | 25/870-13 | CIHE-35 |
| 3123655R1 | D7003 | 25/4047-12 | CIHE-37 |
| 3123835R1 | 03123835R1 | 25/871-10 | CIHE-35 |
| 3124479R93 | 03124479R93 | 62/940-11 | CIHE-33 |
| 3125132R92 | 03125132R92 | 62/920-4 | CIHE-32 |
| 3125171R1 | 25/3125171 | 25/495-22 | CIHE-27 |
| 3125199R2 | 03125199R2 | 60/161-16 | CIHE-13 |
| 3125255R1 | 03125255R1 | 60/162-17 | CIHE-13 |
| 3125257R91 | 03125257R91 | 25/309-6 | CIHE-28 |
| 3125342R2 | 03125342R2 | 60/161-17 | CIHE-13 |
| 3125386R1 | D7040 | 25/4002-2 | CIHE-41 |
| 3125387R1 | D7042 | 25/4015-2 | CIHE-41 |
| 3125388R1 | D7041 | 25/4016-2 | CIHE-41 |
| 3125391R1 | D7048/S | 25/4040-3 | CIHE-41 |
| 3125392R1 | D7048/F | 25/4041-5 | CIHE-41 |
| 3125395R1 | D7050/S | 25/4074-3 | CIHE-41 |
| 3125396R1 | D7050/F | 25/4075-3 | CIHE-41 |
| 3125412R1 | D6772 | 25/4072-22 | CIHE-41 |
| 3125425R1 | 03125425R1 | 25/870-14 | CIHE-35 |
| 3125457R1 | D7044 | 25/4035-1 | CIHE-41 |
| 3125458R1 | D7043 | 25/4034-1 | CIHE-41 |
| 3125459R1 | D7046 | 25/4037-1 | CIHE-41 |
| 3125460R1 | D7045 | 25/4036-1 | CIHE-41 |
| 3125824R1 | | 25/411-14 | CIHE-21 |
| 3127956R1 | 25/3057575 | 25/180-7 | CIH-12, CIHE-8 |
| 3129035R1 | 03129035R91 | 25/181-18 | CIHE-16 |
| 3129139R1 | 25/3129139 | 25/144-25 | CIHE-10 |
| 3129140R1 | 25/3129140 | 25/144-26 | CIHE-10 |
| 3129384R1 | 54E247/379 | 62/931-5 | CIHE-33 |
| 3129643R91 | | 25/410-13 | CIH-30, CIHE-21 |
| 3129807R92 | | 25/226-4 | CIH-29, CIHE-20 |
| 3129834R1 | 03129834R1 | 25/221-46 | CIHE-20 |
| 3129851R91 | 15/1276 | 62/920-10 | CIHE-32 |
| 3131012R31 | R3131012 | 25/450-19 | CIH-33 |
| 3131013R1 | 25/3131013 | 25/461-22 | CIH-33 |
| 3131014R1 | 25/3131014 | 25/464-4 | CIH-33 |
| 3131016R1 | R3131016 | 25/492-22 | CIH-39 |
| 3131021R2 | R3131021 | 25/491-22 | CIH-39 |
| 3131033R1 | 25/3131033 | 25/476-13 | CIH-32 |
| 3131226R91 | 25/3131226 | 25/961-3 | CIH-24 |
| 3131227R1 | 10/12498 | 63/1955-382 | CIH-20 |
| 3131234R1 | 10/12500 | 63/1955-380 | CIH-20 |
| 3131386R1 | 25/3131386 | 25/461-20 | CIH-33 |
| 313163R91 | HPF8/T | 69/905-5 | CIH-45 |
| 3131889R91 | R3058286 | 85/177-24 | CIH-24 |
| 3132018R2 | 03132018R2 | 25/28-14 | CIH-3, CIHE-3 |
| 3132022R92 | 305/F | 60/97-4 | CIH-14 |
| 3132023R92 | 189(IH) | 60/97-11 | CIH-14 |
| 3132101R91 | 25/3218422 | 25/3-46 | CIH-3 |
| 3132101R91(x4) | | 25/3-34 | CIH-3 |
| 3132144R1 | | 25/142-4 | CIHE-11 |
| 3132197R1 | 25/3132197 | 25/112-5 | CIH-14, CIHE-14 |
| 3132428R2 | 1194/F | 60/111-16 | CIH-14, CIHE-13 |
| 3132676R93 | R3132676 | 25/130-30 | CIH-11 |
| 3132697R92 | R3132697 | 25/100-24 | CIH-9, CIHE-10 |
| 3132717R1 | | 25/6050-1 | CIH-14 |

Las referencias originales tienen un propósito identificativo.
Nuestras piezas no son originales.

Part numbers are quoted for reference purposes only.
Our parts and accessories are not original.



"THE RELIABLE SERVICE"



LISTA DE REFERENCIAS CRUZADAS (OEM)
CROSS REFERENCES (OEM)

| OEM OEM | REF. ANTIGUA OLD REF. | REF. n° ORDER N° | PAGINA PAGE | OEM OEM | REF. ANTIGUA OLD REF. | REF. n° ORDER N° | PAGINA PAGE |
|-------------|-----------------------|------------------|---------------------------------|------------|-----------------------|------------------|-----------------------------------|
| 3132718R1 | | 25/149-3 | CIH-14 | 3140173R2 | 25/3140173 | 25/744-7 | CIH-47 |
| 3132719R1 | 25/3132719 | 25/142-6 | CIH-13, CIHE-11 | 3140174R2 | 25/3140714 | 25/746-7 | CIH-47 |
| 3132720R1 | 25/3132720 | 25/142-7 | CIH-13 | 3140498R91 | | 60/240-35 | CIH-18 |
| 3132737R93 | 03132737R93 | 60/97-12 | CIH-14, CIHE-13 | 3140895R92 | BH704104 | 69/7611-1 | CIH-45 |
| 3132738R93 | R3136217 | 25/130-58 | CIH-11 | 3140943 R1 | R3140943 | 25/497-24 | CIH-42 |
| 3132739R93 | R3132739 | 25/130-28 | CIHE-11 | 3141177R91 | 328015316 | 25/212-14 | CIH-28 |
| 3132741R93 | R3132741 | 25/130-59 | CIH-11 | 3141177R91 | R3141177 | 25/212-34 | CIH-28 |
| 3132968R93 | | 25/1-55 | CIH-3, CIHE-3 | 3141185 | R3141185 | 25/221-59E | CIH-28 |
| 3133521R1 | R3133521 | 25/6403-10 | CIH-37 | 3141246 | 25/3226000 | 25/748-2 | CIH-47 |
| 3134146R1 | 25/3134146 | 25/151-13 | CIH-12 | 3141506R2 | 25/3141506 | 25/480-17 | CIH-32 |
| 3134496R91 | R3134496K | 25/421-17 | CIH-30 | 3141509R93 | R3405619 | 25/470-77 | CIH-32 |
| 3134506R1 | 25/3134506 | 25/153-33 | CIH-13 | 3141510R93 | R3405618 | 25/471-77 | CIH-32 |
| 3134507R1 | 25/3134507 | 25/153-34 | CIH-13 | 3141512R91 | R3141529 | 25/581-7 | CIH-42, CIHE-27 |
| 3134664R91 | 25/3134664 | 25/417-16 | CIHE-21 | 3141530R91 | R3141530 | 25/581-5 | CIH-40, CIH-41 |
| 3134665R91 | R/G250068 | 25/240-17 | CIH-30 | 3141531R91 | R3141531 | 25/581-8 | CIH-42 |
| 3134668R3 | R3134668K | 25/421-15 | CIH-30 | 3141532R93 | R3141532 | 25/581-6 | CIH-40, CIH-41 |
| 3134875R91 | 225004411 | 25/200-53 | CIH-25 | 3141565R93 | 228003810 | 25/200-59 | CIH-28 |
| 3134885R2 | 323004216 | 25/212-12 | CIH-25 | 3141567R93 | 328010710 | 25/221-59E | CIH-28 |
| 3134885R2 | R3134885 | 25/212-12E | CIH-25 | 3141567R93 | R3141567 | 25/221-59E | CIH-28 |
| 3134952R1 | 25/3134952 | 25/486-26 | CIH-36 | 3141807R92 | R3141807K | 25/1101-12K | CIH-47 |
| 3134990R91 | 25/3134990 | 25/372-22 | CIH-31 | 3142068R5 | 25/3142068R5 | 25/961-2 | CIH-24 |
| 3136002R91 | | 25/101-24 | CIH-9, CIHE-10 | 3142096R91 | R3148938 | 69/565-20 | CIH-43 |
| 3136046R93 | 03116609R92 | 60/97-9 | CIHE-13 | 3142097R91 | 25/3145248BX | 69/566-4 | CIH-43 |
| 3136053R92 | R3132739 | 25/130-28 | CIHE-11 | 3142097R91 | R3145248 | 69/565-4 | CIH-43 |
| 31361187R91 | 1194F | 60/111-16 | CIHE-13 | 3142099R91 | R3142099 | 25/221-117 | CIH-27 |
| 3136187R91 | 1194F | 60/111-16 | CIH-14, CIHE-13 | 3142103R91 | 25/463-19 | 25/463-19 | CIH-33 |
| 3136203R11 | | 25/3-46A | CIH-3 | 3142105R91 | R629790 | 25/463-20 | CIH-33 |
| 3136217R92 | R3136217 | 25/130-58 | CIH-11 | 3142128R91 | 1861450001 | 25/221-48 | CIH-27 |
| 3136258R1 | 25/3136258 | 25/144-28 | CIH-12 | 3142132R1 | 25/3142132 | 25/479-16 | CIH-32 |
| 3136329R11 | | 25/3-46B | CIH-3 | 3142563R91 | R3145619 | 69/565-21 | CIH-43 |
| 3136429R95 | 25/3136429R95 | 25/90-35 | CIH-9, CIHE-9 | 3142880R91 | 25/3142880 | 25/231-14 | CIH-25, CIH-26, CIH-27, CIH-28 |
| 3136430R95 | 25/3136430R95 | 25/90-36 | CIH-9, CIHE-9 | | | 25/417-20 | CIH-30 |
| 3136431R95 | 25/3136431R95 | 25/90-37 | CIH-9, CIHE-9 | 3142883R94 | | 25/142-5 | CIHE-11 |
| 3136432R95 | 25/3136432R95 | 25/90-38 | CIH-9 | 3144028R1 | 03144028R1 | 60/111-3 | CIH-14, CIHE-13 |
| 3136433R95 | 25/3136433R95 | 25/90-39 | CIH-9 | 3144477R92 | 1087/PK | 25/112-4 | CIH-14, CIHE-14 |
| 3136458R91 | 305/F | 60/97-4 | CIH-14 | 3144478R1 | R3144478 | 25/31-113 | CIH-4 |
| 3136459R91 | 189(IH) | 60/97-11 | CIH-14 | 3144516R97 | 25/3144516K | 25/1-56 | CIH-3, CIHE-3 |
| 3136460R91 | 03132737R93 | 60/97-12 | CIH-14 | 3144626R92 | | 25/130-60 | CIH-11 |
| 3136798R99 | 25/3136798 | 25/71-48 | CIH-8, CIHE-8 | 3144661R93 | 25/3144661 | 25/35-66 | CIH-4, CIH-5, CIHE-4, CIHE-5 |
| 3136799R99 | 25/3136799 | 25/71-49 | CIH-8, CIHE-8 | 3144682R3 | 25/3144682 | | CIH-3 |
| 3136801R99 | 25/3136801 | 25/71-50 | CIH-8 | | | 25/3-25 | CIH-3 |
| 3136802R99 | 25/3136802 | 25/72-48 | CIH-8, CIHE-8 | 3144688R92 | 25/3144688 | 25/75-51 | CIH-8 |
| 3136813R99 | 25/3136813 | 25/72-49 | CIH-8, CIHE-8 | 3144697R2 | 25/3144697 | 25/34-67 | CIH-4, CIH-6, CIHE-4, CIHE-6 |
| 3136817R99 | 25/3136817 | 25/72-50 | CIH-8 | 3144977R91 | 25/3144977 | | CIH-8 |
| 3136852R1 | R3136852 | 25/950-18 | CIH-22 | | | 25/371-16 | CIH-31 |
| 3136858R11 | 25/3136858 | 25/231-15 | CIH-25, CIH-26 | 3145061R91 | 25/3145061 | 25/743-8 | CIH-47 |
| 3137474R2 | R3137474 | 25/105-11 | CIH-12 | 3145157R1 | 25/3145157 | 69/565-4 | CIH-43 |
| 3137538R2 | R3137538 | 25/446-11 | CIH-33 | 3145248R93 | R3145248 | 69/566-4 | CIH-43 |
| 3137660R1 | R3137660 | 25/704-11 | CIH-47, CIHE-31 | 3145248R93 | 25/3145248BX | 25/200-49 | CIH-27 |
| 3137677R3 | R3137677 | 25/221-56 | CIH-26 | 3145303R1 | 1880083111 | 25/420-5 | CIH-30 |
| 3138641R1 | 25/3138641 | 25/74-27 | CIH-8, CIHE-8 | 3145546R92 | 25/3145546 | 69/565-21 | CIH-43 |
| 3138642R2 | 25/3138642 | 25/74-28 | CIH-8, CIHE-8 | 3145619R92 | R3145619 | 25/165-34 | CIH-19 |
| 3138688R2 | 25/3138688 | 25/74-29 | CIH-8 | 3145624R9 | 25/3145624 | 25/1912-27 | CIH-21 |
| 3138701R91 | 25/3138701 | 25/13-16 | CIH-3, CIHE-3 | 3145942R91 | 25/3145942 | 25/1912-28 | CIH-21 |
| 3138834R1 | | 25/59-8 | CIH-3 | 3145943R91 | 25/3145943 | 25/1913-27 | CIH-21 |
| 3138935R1 | 25/3138935 | 25/144-27 | CIH-12 | 3145945R1 | 25/3145945 | 25/1913-28 | CIH-21 |
| 3138936R92 | R3138936 | 25/130-29 | CIH-11 | 3145946R1 | 25/3145946 | 25/581-14 | CIH-42 |
| 3139586R95 | 25/3139586K | 25/31-64 | CIH-4, CIHE-4 | 3146035R92 | R3146035 | 25/470-76 | CIH-32 |
| 3139587R3 | 25/3139587 | 25/35-62 | CIH-4, CIH-5, CIHE-4, CIHE-5 | 3146320R95 | R3405615 | 25/471-76 | CIH-32 |
| | | | CIH-4, CIHE-4 | 3146322R95 | R3405599 | 25/470-75 | CIH-32 |
| 3139591R96 | 25/3139591K | 25/31-65 | CIH-4, CIH-5, CIHE-4, CIHE-5 | 3146323R95 | R3405600 | 25/471-75 | CIH-32 |
| 3139592R4 | 25/3139592 | 25/35-63 | CIH-4, CIH-6, CIHE-4, CIHE-6 | 3146372R92 | 25/3146372 | 25/747-4 | CIH-47 |
| | | | CIH-4, CIH-6, CIHE-4, CIHE-6 | 3146446R93 | R3146446 | 69/565-24 | CIH-44 |
| 3139594R91 | 25/3139594 | 25/34-65 | CIH-25 | 3146449R97 | 231000310 | 25/200-119 | CIH-28 |
| | | | CIH-25 | 3146450R91 | R3146446 | 69/565-24 | CIH-44 |
| 3139819R91 | 1881009201 | 25/200-112 | CIH-25 | 3146576R1 | 2467 | 60/161-19 | CIH-14 |
| 3139821R91 | 1881009201 | 25/200-112 | CIH-25 | 3146733R1 | R3146733 | 25/497-23 | CIH-42 |
| 3140005R1 | R3140005 | 25/743-8 | CIH-47 | 3146927R1 | 2452 | 60/161-18 | CIH-14 |
| 3140076R93 | R3405615 | 25/470-76 | CIH-32 | 3146939R1 | 2427 | 60/161-35 | CIH-14 |
| 3140077R93 | R3405614 | 25/471-76 | CIH-32 | 3147053R1 | 331001110 | 25/221-119 | CIH-28 |
| 3140078R94 | R3405599 | 25/470-75 | CIH-32 | 3147057R91 | 331001211 | 25/212-37 | CIH-28 |
| 3140079R94 | R3405600 | 25/471-75 | CIH-32 | 3147440R91 | BH704104 | 69/7611-1 | CIH-45 |
| 3140082R1 | 25/3140082 | 25/485-21 | CIH-36 | | | | |

Las referencias originales tienen un propósito identificativo.
Nuestras piezas no son originales.

Part numbers are quoted for reference purposes only.
Our parts and accessories are not original.



LISTA DE REFERENCIAS CRUZADAS (OEM)
CROSS REFERENCES (OEM)

| OEM OEM | REF. ANTIGUA OLD REF. | REF. n° ORDER N° | PAGINA PAGE | OEM OEM | REF. ANTIGUA OLD REF. | REF. n° ORDER N° | PAGINA PAGE |
|-------------|-----------------------|------------------|-----------------------------------|------------|-----------------------|------------------|---------------------------|
| 3147441R92 | R3147441 | 60/240-46 | CIH-14 | 3220372R2 | 25/3220372 | 25/440-10 | CIH-37 |
| 3147510R1 | 25/3147510 | 25/492-17 | CIH-39 | 3220434R1 | 25/3220434 | 25/153-35 | CIH-13 |
| 3147525R1 | 25/3147525 | 25/491-18 | CIH-39 | 3220435R1 | 25/3220435 | 25/154-35 | CIH-13 |
| 3147535R92 | 25/3147535BX | 69/566-8 | CIH-43 | 3220450R94 | 25/3220450 | 25/420-7 | CIH-30 |
| 3147535R92 | 25/3147535BX | 69/565-8 | CIH-43 | 3220670R2 | R3220670K | 25/743-9K | CIH-46, CIH-47 |
| 3147535R94 | R3147535 | 69/565-8 | CIH-43 | 3220807R94 | 231002314 | 25/200-60 | CIH-27 |
| 3147877R91 | 25/3147877 | 25/231-13 | CIH-26, CIH-27, CIH-28 | 3220985R98 | 235000310 | 25/200-120 | CIH-28 |
| 3147878R1 | 9665 | 60/162-19 | CIH-14 | 3221116R91 | | 25/6491-7 | CIH-35 |
| 3148080R1 | 9667 | 60/162-18 | CIH-14 | 3221117R91 | | 25/6491-6 | CIH-35 |
| 3148117R1 | 25/3148117 | 25/153-32 | CIH-13 | 3221154R91 | R3405762 | 25/950-17 | CIH-23 |
| 3148492R91 | 25/3148492 | 25/1912-31 | CIH-21 | 3221209R92 | 25/3221209 | 25/1912-32 | CIH-21 |
| 3148499 R1 | R3148499 | 25/1913-31 | CIH-21 | 3221210R92 | 25/3221210 | 25/1912-33 | CIH-21 |
| 3148501R1 | 25/3148501 | 25/1919-3 | CIH-20 | 3221211R91 | 25/3221211 | 25/1918-11 | CIH-20 |
| 3148646R92 | | 25/6491-11 | CIH-35 | 3221253R1 | 25/3221253 | 25/105-10 | CIH-12 |
| 3148647R92 | | 25/6491-12 | CIH-35 | 3221270R91 | R3221270 | 25/581-17 | CIH-42 |
| 3148651R1 | R3224325 | 25/6403-18 | CIH-37, CIHE-26 | 3221271R93 | R3221271 | 25/581-18 | CIH-42 |
| 3148826R2 | 25/3148826 | 25/870-36 | CIH-52 | 3221531R1 | 25/3221531 | 25/870-10 | CIH-52 |
| 3148923R1 | 25/3148923 | 25/495-24 | CIH-39 | 3221572R1 | 25/3221572 | 25/871-8 | CIH-52 |
| 3148925R1 | 25/3148925 | 25/491-17 | CIH-39 | 3221931R91 | 25/3221931 | 25/581-9 | CIH-42 |
| 3148926R1 | 25/3148926 | 25/497-13 | CIH-39, CIH-40, CIH-41 | 3221932R92 | 25/3221932 | 25/581-10 | CIH-42 |
| 3148929R1 | 25/3148929 | 25/495-29 | CIH-41 | 3223263R91 | 25/3223263 | 25/1912-29 | CIH-21 |
| 3148938R92 | R3148938 | 69/565-20 | CIH-43 | 3223264R91 | 25/3223264 | 25/1912-30 | CIH-21 |
| 3148964R91 | R3148964 | 25/221-113 | CIH-25 | 3223350R91 | | 25/6491-9 | CIH-35 |
| 3153187R1 | 2465 | 60/161-60 | CIH-17 | 3223354R92 | | 25/6491-10 | CIH-35 |
| 3153188R1 | 2466 | 60/162-25 | CIH-17 | 3223932R92 | 25/3223932BX | 69/566-25 | CIH-44 |
| 3206527R91 | 54E244/973 | 62/932-4 | CIHE-33 | 3223932R94 | R3223932 | 69/565-25 | CIH-44 |
| 3216100R1 | 9649 | 60/162-20 | CIH-14 | 3223955R1 | | 25/6403-17 | CIH-37, CIHE-26 |
| 3216105R91 | 25/3216105 | 25/372-15 | CIH-31 | 3223995R1 | 25/3223995 | 25/495-27 | CIH-39 |
| 3216397R91 | R3216397 | 25/221-54E | CIH-25 | 3223996R1 | 25/3223996 | 25/495-28 | CIH-40 |
| 3216398R94 | 225004411 | 25/200-53 | CIH-25 | 3223997R1 | 25/3223997 | 25/497-14 | CIH-39, CIH-40, CIH-41 |
| 3216613R91 | R3147535 | 69/565-8 | CIH-43 | 3224265R1 | 25/3224265 | 25/581-11 | CIH-40, CIH-41 |
| 3216613R91 | R3147535 | 69/566-8 | CIH-43 | 3224266R92 | 25/3224266 | 25/581-12 | CIH-40, CIH-41 |
| 3216683R5 | 25/3216683 | 25/165-33 | CIH-19 | 3224268R3 | 25/3224268 | 25/480-18 | CIH-32 |
| 3216691R1 | 25/1342719 | 25/6403-8 | CIH-37, CIHE-26 | 3224286R1 | 25/3224286 | 25/1913-32 | CIH-21 |
| 3216754R1 | 25/3216754 | 25/154-32 | CIH-13 | 3224287R1 | 25/3224287 | 25/1913-33 | CIH-21 |
| 3217279R1 | 25/3217279 | 25/497-21 | CIH-42 | 3224290R1 | R3224290 | 25/1919-11 | CIH-20 |
| 3217467R1 | R3224326 | 25/6403-19 | CIH-37, CIHE-26 | 3224325R1 | R3224325 | 25/6403-18 | CIH-37, CIHE-26 |
| 3217563R1 | 25/3217563 | 25/495-26 | CIH-40 | 3224326R1 | R3224326 | 25/6403-19 | CIHE-26 |
| 3217969R1 | | 60/240-35 | CIH-18 | 3224423R93 | 25/3224423 | 25/221-60E | CIH-27 |
| 3218239R91 | K552 | 62/920-23 | CIH-48 | 3224423R93 | 331007511 | 25/221-60 | CIH-27 |
| 3218248R2 | 25/3218248 | 25/117-53 | CIH-10, CIHE-9 | 3224545R92 | 229000112 | 25/200-55 | CIH-25, CIH-26 |
| 3218249R93 | 25/3218249 | 25/117-55 | CIH-10 | 3224546R92 | 25/3224546 | 25/221-55E | CIH-26, CIH-27 |
| 3218251R2 | 25/3218251 | 25/117-52 | CIH-10, CIHE-9 | 3224546R92 | 329000116 | 25/221-55 | CIH-26, CIH-27 |
| 3218255R2 | 25/3218255 | 25/117-58 | CIH-10 | 3224623R1 | 25/3405722 | 60/240-44 | CIH-14 |
| 3218257R1 | | 25/6050-2 | CIH-14 | 3225094R3 | 330001512 | 25/221-58 | CIH-26 |
| 3218330R1 | | 25/6050-2 | CIH-14 | 3225094R3 | R3225094/E | 25/221-58E | CIH-26 |
| 3218393R91 | 410002600 | 25/230-9 | CIH-25, CIH-26, CIH-27, CIH-28 | 3225465R2 | 25/3225465 | 25/870-11 | CIH-52 |
| 3218399R91 | 25/3218399 | 25/47-6 | CIH-7, CIHE-7 | 3225760R1 | HB47/SACPO | 69/7609-1 | CIH-45 |
| 3218416R92 | 25/3218416 | 25/34-62 | CIH-4, CIH-6, CIHE-4, CIHE-6 | 3225950R1 | R3225950 | 25/221-57 | CIH-26 |
| 3218422 R91 | | 25/3-47 | CIH-3 | 3225978R93 | 325010016 | 25/221-53 | CIH-25 |
| 3218461R95 | 25/3218461K | 25/31-67 | CIH-4, CIHE-4 | 3225978R93 | R3225978 | 25/221-53E | CIH-25 |
| 3218544R91 | 15/1215 | 62/920-64 | CIH-48 | 3226000R1 | 25/3226000 | 25/748-2 | CIH-47 |
| 3218577R91 | 15/1116 | 62/920-38 | CIH-48 | 3226117R1 | 25/3226117 | 25/1913-29 | CIH-21 |
| 3218615R91 | 25/3218615 | 25/75-48 | CIHE-8 | 3226118R1 | 25/3226118 | 25/1913-30 | CIH-21 |
| 3218668R94 | 25/3218668K | 25/31-66 | CIH-4, CIHE-4 | 3226119R1 | 25/3226119 | 25/1918-9 | CIH-20 |
| 3218669R91 | 25/3218669 | 25/34-66 | CIH-4, CIH-6, CIHE-4, CIHE-6 | 3226120R1 | 25/3226120 | 25/1918-10 | CIH-20 |
| 3218758R95 | 25/3218758K | 25/31-62 | CIH-4, CIHE-4 | 3226351R3 | D7012 | 25/4072-25 | CIH-55, CIHE-38 |
| 3218759R95 | 25/3218759K | 25/31-63 | CIH-4, CIHE-4 | 3226416R1 | 2402 | 60/161-31 | CIH-14 |
| 3218793R91 | 5006/F | 60/111-25 | CIH-14, CIHE-13 | 3226551R98 | 235000310 | 25/200-120 | CIH-28 |
| 3218794R91 | 1194/F | 60/111-16 | CIH-14, CIHE-13 | 3226552R98 | 235000410 | 25/200-121 | CIH-28 |
| 3218915R95 | 25/3218915K | 25/31-114 | CIH-4 | 3226762R4 | 25/3226762R4 | 25/165-92 | CIH-19 |
| 3219420R1 | 2402 | 60/161-31 | CIH-16 | 3226798R1 | 25/3226798 | 25/154-91 | CIH-13 |
| 3219421R1 | 9650 | 60/162-31 | CIH-14 | 3226942R93 | R3226942 | 69/565-29 | CIH-44 |
| 3220032R91 | 25/3220032 | 25/371-17 | CIH-31 | 3228019R1 | 25/3144182 | 25/73-50 | CIH-8 |
| 3220034R93 | 25/3220034 | 25/372-23 | CIH-31 | 3228133R93 | 25/3228133 | 25/11-19 | CIH-3, CIHE-3 |
| 3220221R93 | R3220221 | 69/565-28 | CIH-44 | 3228192R91 | 15/005061H | 62/930-21 | CIH-49 |
| 3220221R93 | 25/3220221BX | 69/566-28 | CIH-44 | 3228192R91 | 15/00705 | 62/930-55 | CIH-49 |
| 3220369R96 | 25/3220369 | 25/165-37 | CIH-19 | 3228193R91 | 15/00704 | 62/930-54 | CIH-49 |
| | | | | 3228193R91 | R3055414 | 62/930-22 | CIH-49 |
| | | | | 3228344R1 | 25/3228344 | 25/38-62 | CIH-4, CIHE-4 |
| | | | | 3228348R1 | 25/3228348 | 25/38-63 | CIH-4, CIHE-4 |
| | | | | 3228361R2 | 25/3138959 | 25/73-48 | CIH-8, CIHE-8 |

Las referencias originales tienen un propósito identificativo.
Nuestras piezas no son originales.

Part numbers are quoted for reference purposes only.
Our parts and accessories are not original.



"THE RELIABLE SERVICE"



LISTA DE REFERENCIAS CRUZADAS (OEM)
CROSS REFERENCES (OEM)

| OEM OEM | REF. ANTIGUA OLD REF. | REF. n° ORDER N° | PAGINA PAGE | OEM OEM | REF. ANTIGUA OLD REF. | REF. n° ORDER N° | PAGINA PAGE |
|------------|--------------------------|---------------------|-----------------------------|------------|--------------------------|---------------------|-----------------|
| 3228362R1 | 25/3144181 | 25/73-49 | CIH-8 | 3401843R1 | R3401843 | 25/495-25 | CIH-39 |
| 3228401R91 | 25/3228401 | 25/11-18 | CIH-3, CIHE-3 | 3404116R91 | 229000111 | 25/200-116 | CIH-27 |
| 3228525R91 | | 25/230-11 | CIH-27, 28 | 3404117R91 | 323004211 | 25/212-33 | CIH-27 |
| 3228663R91 | | 25/3-47A | CIH-3 | 3404170R94 | R3404170 | 25/181-19 | CIH-20 |
| 3228667R91 | | 25/3-47B | CIH-3 | 3404225R1 | 25/3404225 | 25/153-91 | CIH-13 |
| 3229694R2 | R3229694 | 25/177-26 | CIH-24 | 3404966R4 | 25/3404966 | 25/165-35 | CIH-19 |
| 3229787R1 | | 60/240-35 | CIH-18 | 3405599R1 | R3405599 | 25/470-75 | CIH-32 |
| 3229812R1 | 25/3229812 | 25/450-20 | CIH-33 | 3405600R1 | R3405600 | 25/471-75 | CIH-32 |
| 3229813R91 | 25/463-22 | 25/463-22 | CIH-33 | 3405601R1 | R3405599 | 25/470-75 | CIH-32 |
| 3229907R1 | R/G250068 | 25/240-17 | CIH-30 | 3405602R1 | R3405600 | 25/471-75 | CIH-32 |
| 3230079R1 | R3405599 | 25/470-75 | CIH-32 | 3405613R1 | R3405615 | 25/470-76 | CIH-32 |
| 3230080R1 | R3405600 | 25/471-75 | CIH-32 | 3405614R1 | R3405614 | 25/471-76 | CIH-32 |
| 3230092R1 | R3405615 | 25/470-76 | CIH-32 | 3405615R1 | R3405615 | 25/470-76 | CIH-32 |
| 3230093R1 | R3405614 | 25/471-76 | CIH-32 | 3405616R1 | R3405614 | 25/471-76 | CIH-32 |
| 3230097R1 | R3405619 | 25/470-77 | CIH-32 | 3405617R1 | R3405619 | 25/470-77 | CIH-32 |
| 3230098R1 | R3405618 | 25/471-77 | CIH-32 | 3405618R1 | R3405618 | 25/471-77 | CIH-32 |
| 3230099R1 | 25/3230099 | 25/581-11 | CIH-40 | 3405619R1 | R3405619 | 25/470-77 | CIH-32 |
| 3230179R91 | | 25/6491-8 | CIH-35 | 3405619R1 | R3405619 | 25/470-77 | CIH-32 |
| 3230277R1 | R3230277 | 25/6403-7 | CIH-37, CIHE-26 | 3405620R1 | R3405618 | 25/471-77 | CIH-32 |
| 3230348R2 | | 25/441-9 | | 3405722R2 | 25/3405722 | 60/240-44 | CIH-14 |
| 3230364R1 | 25/3230364 | 25/497-22 | CIH-42 | 3405762R1 | R3405762 | 25/950-17 | CIH-23 |
| 3230720R4 | 335008010 | 25/221-120 | CIH-28 | 369857R1 | 0369857R1 | 25/451-5 | CIHE-23 |
| 3230726R3 | 335008110 | 25/221-121 | CIH-28 | 370254R91 | 461-18 | 25/461-18 | CIHE-23 |
| 3230784R1 | 25/3230784 | 25/441-10 | CIH-37 | 371881R91 | | 25/463-14 | CIHE-23 |
| 3230875R2 | 441-11 | 25/441-11 | CIH-37 | 376099R1 | 477-14 | 25/477-14 | CIHE-22 |
| 3230986R98 | 235000410 | 25/200-121 | CIH-28 | 376855R92 | R3055238 | 25/186-6 | CIH-12, CIHE-8 |
| 3231505R91 | | 63/1920-6 | CIH-21 | 379748R1 | 0379748R1 | 25/583-1 | CIHE-24 |
| 3232760R2 | 25/3232760 | 25/872-12 | CIH-52 | 380200R92 | 0380200R92 | 25/376-7 | CIHE-29 |
| 3232806R1 | 25/464-5 | 25/464-5 | CIH-33 | 384695R91 | 0384695R91 | 25/372-18 | CIHE-29 |
| 3232807R1 | 25/3232807 | 25/461-23 | CIH-33 | 398080R2 | | 60/97-37 | CIHE-13 |
| 3232808R91 | 25/462-23 | 25/462-23 | CIH-33 | 399762R3 | 0399762R3 | 25/385-4 | CIHE-29 |
| 3232813R1 | R323813 | 25/476-14 | CIH-32 | 40090D | | 25/477-13 | CIHE-22 |
| 3232820R91 | 25/463-23 | 25/463-23 | CIH-33 | 400989C91 | 462-18 | 25/462-18 | CIHE-23 |
| 3232821R1 | 25/3232821R1 | 25/477-17 | CIH-32 | 402189R1 | 0402189R1 | 25/154-29 | CIHE-12 |
| 3232822R1 | 25/3232822 | 25/486-27 | CIH-36 | 402191R1 | 0402191R1 | 25/153-29 | CIHE-12 |
| 3232823R1 | 25/3232823 | 25/485-22 | CIH-36 | 402205R1 | 0402205R1 | 25/154-31 | CIHE-12 |
| 3232877R92 | 25/3232877 | 25/497-15 | CIH-40, CIH-41 | 402207R1 | 0402207R1 | 25/153-31 | CIHE-12 |
| 3232937R1 | 25/3232937 | 25/872-14 | CIH-52, CIHE-35 | 404341R3 | 0404341R3 | 25/440-7 | CIHE-26 |
| 3233032R1 | D7018 | 25/4073-14 | CIH-55, CIHE-38, CIHE-39 | 405570R1 | 0405570R1 | 25/486-14 | CIHE-24 |
| 3233036R1 | | 25/4012-23 | CIH-38 | 405574R1 | 0405574R1 | 25/584-1 | CIHE-24 |
| 3233040R1 | D7015 | 25/4085-1 | CIH-55, CIHE-38, CIHE-39 | 405576R1 | 0405576R1 | 25/484-3 | CIHE-24 |
| 3233041R1 | D7016 | 25/4086-1 | CIH-55, CIHE-38, CIHE-39 | 405580R11 | 0405580R11 | 25/572-1 | CIHE-24 |
| 3233045R1 | D7010 | 25/4000-36 | CIH-55, CIHE-38, CIHE-39 | 405584R2 | 0405584R2 | 25/483-3 | CIHE-24 |
| 3233046R3 | D7017 | 25/4072-24 | CIH-55, CIHE-38, CIHE-39 | 405840R12 | 0405840R12 | 25/470-68 | CIHE-22 |
| 3233051R1 | D7014 | 25/4027-2 | CIH-55, CIHE-38, CIHE-39 | 406295R2 | 0406295R2 | 25/464-2 | CIHE-23 |
| 3233053R1 | D7013 | 25/4026-2 | CIH-55, CIHE-38, CIHE-39 | 406951R2 | 0406951R2 | 25/442-3 | CIHE-26 |
| 3233186R91 | 25/3233186 | 25/581-16 | CIH-40, CIH-41 | 406953R1 | 0406953R1 | 25/443-3 | CIHE-26 |
| 3233584R2 | | 60/4200-2 | CIH-14, CIHE14 | 427639R1 | R427639 | 25/452-1 | CIH-33, CIHE-23 |
| 3233850R91 | 25/479-17 | 25/479-17 | CIH-32 | 427639R1 | | 25/452-6 | |
| 3234163R1 | 25/3234163 | 25/870-15 | CIH-52, CIHE-35 | 427645R1 | LN10-5 | 70/457-5 | CIH-33 |
| 3234724R93 | 231002314 | 25/200-60 | CIH-27 | 432988A | 510E249 | 62/920-84 | CIH-48 |
| 3234746R91 | 70/3227 | 70/1987-20 | CIH-53, CIHE-36 | 432988A | 0483879R2 | 25/447-4 | CIHE-23 |
| 3245279 | R3245279 | 25/165-91 | CIH-19 | 48548D | | 25/464-1 | CIHE-23 |
| 330732A1 | | 25/221-183 | CIH-29 | 50259D | 461-17 | 25/461-17 | CIHE-23 |
| 331015410 | 331015410 | 25/221-110 | CIHE-20 | 527292R92 | 0527292R92 | 25/470-69 | CIHE-22 |
| 332123A1 | | 25/221-182 | CIH-29 | 527295R91 | 479-14 | 25/479-14 | CIHE-22 |
| 3399042R1 | 25/3399042 | 25/871-9 | CIH-52 | 527542R92 | | 25/410-14 | CIHE-21 |
| 3399199R1 | 25/3399199 | 25/154-33 | CIH-13 | 527937R1 | 0527937R1 | 25/755-20 | CIHE-30 |
| 3399422R3 | 25/3399422 | 25/871-11 | CIH-52, CIHE-35 | 527940R91 | 0527940R91 | 25/759-21 | CIHE-30 |
| 3399467R1 | 25/3399467 | 25/440-9 | CIH-37 | 527948R91 | 0527948R91 | 25/759-22 | CIHE-30 |
| 3399520R1 | R3399520 | 25/950-16 | CIH-23 | 527967R91 | 0527967R91 | 25/759-20 | CIHE-30 |
| 3399522R2 | R3399522 | 25/958-2 | CIH-23 | 528081R1 | R528081 | 25/704-13 | CIH-47, CIHE-31 |
| 3399576R91 | 10/5417 | 25/4172-27 | CIH-51 | 528084R1 | R528084 | 25/704-12 | CIHE-23 |
| 3401189R94 | R3401189 | 69/565-23 | CIH-43 | 528803R1 | 0528803R1 | 25/446-10 | CIHE-23 |
| 3401189R94 | 25/3401189BX | 69/566-23 | CIH-43 | 529372R1 | R529372 | 25/165-31 | CIHE-15 |
| 3401303R91 | 70/1987-25 | 70/1987-25 | CIH-53, CIHE-36 | 529854R2 | 0529854R2 | 60/161-15 | CIHE-13 |
| | | | | 530102R91 | 0530102R91 | 25/376-8 | CIHE-29 |
| | | | | 530104R91 | 461-14 | 25/461-14 | CIHE-23 |
| | | | | 530144R92 | 0530144R92 | 60/240-42 | CIH-14, CIHE-13 |
| | | | | 532029R1 | R532029 | 25/151-12 | CIHE-11 |
| | | | | 534934R92 | 0534934R1 | 25/309-5 | CIHE-28 |
| | | | | 534936R93 | 0534936R93 | 25/309-4 | CIHE-28 |
| | | | | 536052R91 | 463-18 | 25/363-18 | CIHE-23 |
| | | | | 537140R92 | R537140 | 62/930-13 | CIHE-33 |

Las referencias originales tienen un propósito identificativo.
Nuestras piezas no son originales.

Part numbers are quoted for reference purposes only.
Our parts and accessories are not original.



"THE RELIABLE SERVICE"



LISTA DE REFERENCIAS CRUZADAS (OEM)
CROSS REFERENCES (OEM)

| OEM OEM | REF. ANTIGUA OLD REF. | REF. n° ORDER N° | PAGINA PAGE | OEM OEM | REF. ANTIGUA OLD REF. | REF. n° ORDER N° | PAGINA PAGE |
|------------|-----------------------|------------------|------------------|-----------|-----------------------|------------------|-----------------|
| 544829R91 | 125004530 | 25/200-122 | CIH-29 | 785612R1 | R785612 | 25/446-15 | CIH-33 |
| 547433R91 | 325011330 | 25/221-122 | CIH-29 | 785723R91 | 325011330 | 25/221-122 | CIH-29 |
| 60723C1 | 125004430 | 25/200-123 | CIH-29 | 786460R21 | | 25/417-16 | CIH-30, CIHE-21 |
| 618022R91 | 25/462-13 | 25/462-13 | CIH-33, CIHE-23 | 786532R91 | 25/786532 | 25/231-12 | CIH-25 |
| 625627C1 | 9360 | 60/111-49 | CIH-14 | 787004R22 | | 25/417-1 | CIH-30 |
| 6405618R1 | R3405618 | 25/471-77 | CIH-32 | 787513R91 | 1881089002 | 25/200-111 | CIH-25 |
| 66193C91 | 066193C1 | 25/309-7 | CIHE-28 | 787514R91 | 1881089002 | 25/200-111 | CIH-25 |
| 663556R91 | 25/663556 | 25/462-19 | CIH-33 | 787515R91 | 1861266001 | 25/221-111 | CIH-25 |
| 672603C2 | 5012 | 60/111-45 | CIH-14 | 789818R91 | RR100200 | 25/130-33 | CIH-11 |
| 67328C1 | | 25/464-3 | CIHE-23 | 795662R91 | 25/13-15 | 25/13-15 | CIHE-3 |
| 67526C91 | 067526C91 | 25/470-70 | CIHE-22 | 795730R1 | 25/42-22 | 25/42-22 | CIHE-7 |
| 67535C91 | 067535C91 | 25/470-71 | CIHE-22 | 795775R1 | P3113/4123 | 25/28-13 | CIHE-3 |
| 67537C1 | 067537C1 | 25/451-6 | CIHE-23 | 795840R91 | 143 | 60/96-14 | CIH-14 |
| 67974C4 | 067974C4 | 60/161-28 | CIH-14 | 796189R1 | | 25/4-16 | CIHE-3 |
| 67975C1 | 067975C1 | 60/162-28 | CIH-14 | 796190R1 | 5-16 | 25/5-16 | CIHE-3 |
| 69844C91 | 069844C91 | 25/230-8 | CIHE-20 | 796202R1 | | 25/4-17 | CIHE-3 |
| 69991C91 | 069991C91 | 25/761-20 | CIHE-30 | 796203R1 | 5-17 | 25/5-17 | CIHE-3 |
| 69992C91 | 069992C91 | 25/761-21 | CIHE-30 | 796227R1 | 25/35-61 | 25/35-61 | CIHE-4, CIHE-5 |
| 69993C91 | 069993C91 | 25/761-22 | CIHE-30 | 80318C91 | | 25/229-4 | CIH-29, CIHE-20 |
| 702251C1 | 9360 | 60/111-49 | CIH-14 | 81288C2 | | 25/6407-5 | CIH-34, CIHE-25 |
| 703820R95 | R703820 | 25/130-25 | CIHE-11 | 81291C1 | | 25/6400-9 | CIH-34, CIHE-25 |
| 703883R7 | 0703913R3 | 25/73-33 | CIHE-8 | 81292C1 | | 25/6400-10 | CIH-34, CIHE-25 |
| 703913R3 | 0703913R3 | 25/385-3 | CIHE-29 | 81305C1 | | 25/6450-3 | CIH-34, CIHE-25 |
| 703915R1 | 0703915R1 | 25/371-10 | CIHE-29 | 81306C2 | | 25/6462-8 | CIH-34, CIHE-25 |
| 703929R1 | 0703929R1 | 25/442-2 | CIHE-26 | 81312C2 | | 25/6410-8 | CIH-34, CIHE-25 |
| 704083R92 | 461-13 | 25/461-13 | CIHE-23 | 81319C1 | | 25/6430-4 | CIH-34, CIHE-25 |
| 704092R1 | 0704092R1 | 25/35-42 | CIHE-4, CIHE-5 | 81320C1 | | 25/6406-9 | CIH-34, CIHE-25 |
| 704100R1 | 0704100R1 | 25/38-42 | CIHE-4 | 81325C1 | | 25/6431-8 | CIH-34, CIHE-25 |
| 704287R2 | | 25/154-26 | CIHE-12 | 81411C2 | | 25/6407-6 | CIH-34, CIHE-25 |
| 704289R2 | | 25/153-24 | CIHE-12 | 81413C1 | | 25/6400-4 | CIH-34, CIHE-25 |
| 704330R95 | 0704330R95 | 25/640-26 | CIHE-28 | 81414C1 | | 25/6400-5 | CIH-34, CIHE-25 |
| 704422R93 | 0704422R93 | 25/420-15 | CIHE-21 | 81428C1 | | 25/6450-1 | CIH-34, CIHE-25 |
| 704449R1 | 0704449R1 | 25/144-11 | CIHE-10 | 81429C2 | | 25/6462-2 | CIH-34, CIHE-25 |
| 704455R1 | 0704455R1 | 25/41-12 | CIHE-7 | 81434C1 | | 25/6430-10 | CIH-34, CIHE-25 |
| 704456R2 | 0704456R2 | 25/41-13 | CIHE-7 | 81435C1 | | 25/6406-8 | CIH-34, CIHE-25 |
| 704616R96 | R704616 | 25/165-90 | CIH-19 | 81452C1 | | 25/6430-3 | CIHE-25 |
| 704640R91 | 1005 | 60/111-2 | CIH-14, CIHE-13 | 81453C1 | | 25/6406-1 | CIHE-25 |
| 704641R91 | 1005 | 60/111-2 | CIH-15 | 81455C1 | | 25/6431-4 | CIHE-25 |
| 704675R91 | 0704675R1 | 25/449-11 | CIHE-24 | 81676C1 | | 25/6410-9 | CIH-34 |
| 705525R91 | 0705525R91 | 25/200-39 | CIHE-18 | 81683C1 | | 25/6406-2 | CIH-34 |
| 705542R91 | 0705542R91 | 25/231-9 | CIHE-18, CIHE-19 | 81687C1 | | 25/6401-3 | CIH-34 |
| 705735R91 | 110 | 60/96-5 | CIHE-13 | 81688C1 | | 25/6431-5 | CIH-34 |
| 705747R91 | 110 | 60/96-5 | CIHE-13 | 82363C1 | R82363C1 | 25/1918-8 | CIH-20 |
| 705833R91 | 271E735 | 62/933-2 | CIHE-33 | 82364C1 | R82364C1 | 25/1918-7 | CIH-20 |
| 706105R91 | R706105 | 25/71-33 | CIHE-8 | 83027C1 | 083027C1 | 25/165-32 | CIHE-15 |
| 708294R93 | R708294 | 25/100-22 | CIHE-10 | 84058C1 | 54E268/462 | 62/932-7 | CIHE-33 |
| 708912R91 | 0708912R91 | 25/2-21 | CIHE-3 | 84059C1 | 54E268/555 | 62/931-10 | CIHE-33 |
| 708969R92 | 37LU229 | 62/919-1 | CIHE-32 | 84060C1 | LU77036 | 62/940-13 | CIHE-33 |
| 709502R1 | 0709502R1 | 25/144-23 | CIHE-10 | 84209C2 | 54E268/142 | 62/939-16 | CIHE-33 |
| 709638R95 | 0709638R95 | 25/200-50 | CIHE-18 | 84496C1 | 084496C1 | 25/153-90 | CIHE-12 |
| 709639R94 | 0709639R94 | 25/221-50 | CIHE-18 | 84497C2 | 084497C1 | 25/154-90 | CIHE-12 |
| 709640R92 | 0709640R92 | 25/212-11 | CIHE-18, CIHE-19 | 85025C2 | 131003810 | 25/200-110 | CIHE-20 |
| 710196R1 | 10/12844 | 63/1955-239 | CIH-20 | 85026C3 | 331015410 | 25/221-110 | CIHE-20 |
| 710327 R11 | 25/710327 | 25/9-16 | CIH-3 | 85104C92 | 085104C1 | 25/231-11 | CIHE-20 |
| 710347R2 | 0710347R2 | 25/45-12 | CIHE-7 | 89845C91 | BH704116 | 69/7611-5 | CIH-45 |
| 710348R1 | 0710348R1 | 25/60-8 | CIHE-10 | 89880C91 | R089880C1 | 69/565-27 | CIH-44 |
| 711193R1 | 25/711193 | 25/385-5 | CIH-31 | 90308C1 | R90308C1 | 25/1919-7 | CIH-20 |
| 711199R1 | 25/711199 | 25/371-15 | CIH-31 | 90309C1 | R90309C1 | 25/1919-8 | CIH-20 |
| 711335R1 | 10/12821 | 63/1955-207 | CIH-20 | 905514R1 | 25/905514 | 25/441-8 | CIH-37 |
| 712628R91 | F1007 | 60/111-64 | CIH-14 | 91450C1 | R3055238 | 25/186-6 | CIH-12, CIHE-8 |
| 712794R91 | 25/712794 | 25/372-20 | CIH-31 | 92161C2 | 092161C2 | 25/187-4 | CIHE-8 |
| 7131172R1 | 25/7131172 | 25/371-14 | CIH-31 | 92292C1 | 15/1276 | 62/920-10 | CIHE-32 |
| 715711R91 | 1007 | 60/111-32 | CIH-15 | 92602C91 | 092602C91 | 25/200-46 | CIHE-20 |
| 716195R91 | R716195 | 25/495-70 | CIH-39 | 933602R1 | R933602 | 25/441-14 | CIH-37 |
| 716410R99 | R718891 | 25/130-56 | CIH-11 | 933948R1 | R933948 | 25/447-5 | CIH-33 |
| 716847R91 | 1007 | 60/111-32 | CIH-15 | 934008R1 | R934008 | 25/441-15 | CIH-37 |
| 717678R91 | R716195 | 25/495-70 | CIH-39 | 93835C92 | 093835C92 | 25/640-15 | CIHE-28 |
| 718383R2 | R718383 | 25/117-54 | CIH-10 | 963418M1 | | 25/180-8 | CIHE-8 |
| 718891R97 | R718891 | 25/130-56 | CIH-11 | 972467R91 | 0972467R91 | 25/372-19 | CIHE-29 |
| 737606R1 | HPF8/R | 69/906-5 | CIH-45 | 98604C2 | D7004 | 25/4072-30 | CIHE-37 |
| 751604R92 | R751604K | 25/31-42 | CIHE-4 | 98782C1 | 25/905514 | 25/441-8 | CIH-37 |
| 751761R92 | R3134668K | 25/421-15 | CIH-30, CIHE-21 | 99990C1 | 099990C1 | 25/1 87-5 | CIHE-8 |
| 751848R94 | 0751848R94 | 25/230-7 | CIHE-18, CIHE-19 | A151931 | 25/1329039 | 60/156-3 | CIH-14 |
| 763613R95 | R763613 | 25/130-57 | CIH-11 | A171255 | 25/A171255 | 60/161-79 | CIH-14 |

Las referencias originales tienen un propósito identificativo.
Nuestras piezas no son originales.

Part numbers are quoted for reference purposes only.
Our parts and accessories are not original.



LISTA DE REFERENCIAS CRUZADAS (OEM)
CROSS REFERENCES (OEM)

| OEM OEM | REF. ANTIGUA OLD REF. | REF. n° ORDER N° | PAGINA PAGE | OEM OEM | REF. ANTIGUA OLD REF. | REF. n° ORDER N° | PAGINA PAGE |
|----------|-----------------------|------------------|-----------------------------------|---------|-----------------------|------------------|-------------|
| A171256 | 25/A171256 | 60/162-79 | CIH-14 | UCB100 | 37UCB612 | 62/919-80 | CIHE-32 |
| A184460 | | 25/165-102 | CIH-19 | UCB109 | 37UCB584 | 62/919-81 | CIHE-32 |
| A184475 | | 25/165-103 | CIH-19 | ULB110 | 54E219/368 | 62/923-1 | CIHE-32 |
| A184773 | 9360 | 60/111-49 | CIH-14 | USB104 | 227E541 | 62/913-2 | CIHE-32 |
| A184774 | 5012 | 60/111-45 | CIH-14 | UTB107 | 189E237 | 62/915-1 | CIHE-32 |
| A187597 | 15/30412 | 62/930-52 | CIH-49 | UTB110 | 227E818 | 62/914-1 | CIHE-32 |
| A187623 | 15/8999 | 62/920-76 | CIH-48 | UWB102 | 54E213/780 | 62/911-2 | CIHE-32 |
| A187873 | 15/1953 | 62/920-72 | CIH-48 | | | | |
| A189049 | | 25/166-12 | CIH-19 | | | | |
| A189943 | | 25/166-12 | CIH-19 | | | | |
| A47032 | 2935 | 60/161-65 | CIH-14 | | | | |
| A47033 | 2939 | 60/162-65 | CIH-14 | | | | |
| A77470 | 5007 | 60/111-44 | CIH-14 | | | | |
| A77537 | 2026 | 60/97-47 | CIH-14 | | | | |
| A77544 | 25/1329039 | 60/156-3 | CIH-14, CIHE-13 | | | | |
| A77703 | 25/A77703 | 25/130-61 | CIH-11 | | | | |
| A77704 | 25/A77704 | 25/130-62 | CIH-12 | | | | |
| AAU2906 | | 25/221-186 | CIH-28 | | | | |
| B1036 | 25/B1036 | 25/72-33 | CIHE-8 | | | | |
| B1040 | 25/B1040 | 25/460-19 | CIH-33 | | | | |
| B1044 | 25/B1044 | 25/460-23 | CIH-33 | | | | |
| B1265 | | 25/475-16 | CIHE-22 | | | | |
| B1266 | | 25/475-17 | CIHE-22 | | | | |
| B1267 | | 25/475-48 | CIH-32 | | | | |
| B1268 | | 25/475-19 | CIH-32 | | | | |
| B1269 | | 25/475-20 | CIH-32 | | | | |
| B1270 | | 25/475-21 | CIH-32 | | | | |
| B3161 | 25/31-61 | 25/31-61 | CIHE-4, CIHE-5 | | | | |
| B3361 | 25/B3361 | 25/33-61 | CIHE-4, CIHE-5 | | | | |
| B3362 | | 25/33-62 | CIH-4, CIH-5, CIHE-4, CIHE-5 | | | | |
| B3363 | | 25/33-63 | CIH-4, CIH-5, CIHE-4, CIHE-5 | | | | |
| B3364 | 25/B3364 | 25/33-64 | CIH-4, CIH-5, CIHE-4, CIHE-5 | | | | |
| B3365 | 25/B3365 | 25/33-65 | CIH-4, CIH-5, CIHE-4, CIHE-5 | | | | |
| B3366 | 25/B3366 | 25/33-66 | CIH-4, CIH-5, CIHE-4, CIHE-5 | | | | |
| B3367 | 25/B3367 | 25/33-67 | CIH-4, CIH-5, CIHE-4, CIHE-555 | | | | |
| B503521 | R3132697 | 25/100-24 | CIH-9 | | | | |
| B616 | 6-16 | 25/6-16 | CIHE-3 | | | | |
| B617 | 6-17 | 25/6-17 | CIHE-3 | | | | |
| D56453 | 2465 | 60/161-60 | CIH-14 | | | | |
| H40556 | 10/12814 | 63/1955-245 | CIH-20 | | | | |
| J802358 | 25/A77703 | 25/130-61 | CIH-11 | | | | |
| J802479 | 25/A77704 | 25/130-62 | CIH-12 | | | | |
| J903264 | 2069 | 60/97-51 | CIH-14 | | | | |
| J903410 | 5007 | 60/111-44 | CIH-14 | | | | |
| J903640 | 1157/F | 60/111-56 | CIH-14 | | | | |
| J904374 | 25/100-35 | 25/100-35 | CIH-9 | | | | |
| J908615 | 2069 | 60/97-51 | CIH-14 | | | | |
| J908616 | 2120 | 60/97-53 | CIH-14 | | | | |
| J909476 | 0433171074 | 25/117-59 | CIH-10 | | | | |
| J911558 | | 71/144-89 | CIH-12 | | | | |
| J911562 | | 71/144-90 | CIH-12 | | | | |
| J919562 | 2135 | 60/97-74 | CIH-14 | | | | |
| J925274 | 5007 | 60/111-44 | CIH-14 | | | | |
| J928143 | 25/100-35 | 25/100-35 | CIH-9 | | | | |
| J930336 | | 25/90-43 | CIH-9 | | | | |
| J930337 | | 25/90-40 | CIH-9 | | | | |
| J930338 | | 25/90-41 | CIH-9 | | | | |
| K529965 | R537140 | 62/930-13 | CIHE-33 | | | | |
| K908901 | 37RB408 | 62/919-2 | CIHE-32 | | | | |
| K928523 | D928523 | 25/60-10 | CIHE-10 | | | | |
| K960911 | 1087/PK | 60/111-3 | CIH-14, CIHE-13 | | | | |
| K965215 | 25/965165#& | 25/6403-20 | CIH-37, CIHE-26 | | | | |
| N14377 | 25/497-17 | 25/497-17 | CIH-41 | | | | |
| N14388 | 25/497-44 | 25/497-44 | CIH-41 | | | | |
| N7602 | | 25/227-4 | CIH-29, CIHE-20 | | | | |
| N8153 | 2466 | 60/162-25 | CIH-14 | | | | |
| R322004K | R322004K | 25/133-1 | CIH-11 | | | | |
| ST273A | 25/ST273A | 25/372-21 | CIH-31 | | | | |

Las referencias originales tienen un propósito identificativo.
 Nuestras piezas no son originales.

Part numbers are quoted for reference purposes only.
 Our parts and accessories are not original.



"THE RELIABLE SERVICE"



LISTA DE REFERENCIAS CRUZADAS (Ref. n°)
CROSS REFERENCES (Order N°)

| REF. n° ORDER N° | REF. ANTIGUA OLD REF. | OEM OEM | PAGINA PAGE | REF. n° ORDER N° | REF. ANTIGUA OLD REF. | OEM OEM | PAGINA PAGE |
|---------------------|--------------------------|-----------------|----------------|---------------------|--------------------------|------------|----------------|
| 25/1-3 | P85719 | 3118169R91 | CIHE-3 | 25/33-42 | 03048523R1 | 3048523R1 | CIHE-4, CIHE-5 |
| 25/1-54 | | 3110995R91 | CIHE-3 | 25/33-44 | 03044486R3 | 3044486R3 | CIHE-4, CIHE-5 |
| 25/1-55 | | 1329196C1 | CIH-3, CIHE-3 | 25/33-61 | 25/B3361 | B3361 | CIHE-4, CIHE-5 |
| 25/1-55 | | 3132968R93 | CIH-3, CIHE-3 | 25/33-62 | | B3362 | CIH-4, CIH-5, |
| 25/1-56 | | 3144626R92 | CIH-3, CIHE-3 | | | | CIHE-4, CIHE-5 |
| 25/2-21 | 0708912R91 | 708912R91 | CIHE-3 | 25/33-63 | | B3363 | CIH-4, CIH-5, |
| 25/2-22 | 25/2-22 | 3118150R1 | CIHE-3 | | | | CIHE-4, CIHE-5 |
| 25/2-23 | 25/3055129 (x1) | 3055129R21(x1) | | 25/33-64 | 25/B3364 | B3364 | CIH-4, CIH-5, |
| | +25/3055130(x3) | +3055130R21(x3) | CIH-3, CIHE-3 | | | | CIHE-4, CIHE-5 |
| 25/2-24 | 25/3055129 (x1) | 3055129R21(x1) | | 25/33-65 | 25/B3365 | B3365 | CIH-4, CIH-5, |
| | +25/3055130(x4) | +3055130R21(x4) | CIH-3, CIHE-3 | | | | CIHE-4, CIHE-5 |
| 25/2-26 | 25/3055129 (x1) | 3055129R21(x1) | | 25/33-66 | 25/B3366 | B3366 | CIH-4, CIH-5, |
| | +25/3055130(x6) | +3055130R21(x6) | CIH-3, CIHE-3 | | | | CIHE-4, CIHE-5 |
| 25/3-21 | 03070546R91 | 3070546R91 | CIHE-3 | 25/33-67 | 25/B3367 | B3367 | CIH-4, CIH-5, |
| 25/3-22 | P85042 | 3118135R1 | CIHE-3 | | | | CIHE-4, CIHE-5 |
| 25/3-23 | 25/3055351 (x3) | 3055351R91 (x3) | CIH-3, CIHE-3 | 25/34-42 | 03114775R91 | 3114775R91 | CIHE-4, CIHE-6 |
| 25/3-24 | 25/3055351 | 3055351R91 | CIH-3, CIHE-3 | 25/34-44 | 03114778R91 | 3114778R91 | CIHE-4, CIHE-6 |
| 25/3-25 | 25/3055351 | 3055351R91 | CIH-3, CIHE-3 | 25/34-60 | 25/3059262 | 3059262R92 | CIH-4, CIH-6, |
| 25/3-25 | 25/3144688 | 3144688R92 | CIH-3 | | | | CIHE-4, CIHE-6 |
| 25/3-26 | 25/3055351 | 3055351R91 | CIH-3, CIHE-3 | 25/34-61 | 25/34-61 | 3118131R1 | CIHE-4, CIHE-6 |
| 25/3-34 | | 3132101R91 (X4) | CIH-3 | 25/34-62 | 25/3218416 | 3218416R92 | CIH-4, CIH-6, |
| 25/3-46 | 25/3218422 | 3132101R91 | CIH-3 | | | | CIHE-4, CIHE-6 |
| 25/3-46A | | 3136203R11 | CIH-3 | 25/34-65 | 25/3139594 | 3139594R91 | CIH-4, CIH-6, |
| 25/3-46B | | 3136329R11 | CIH-3 | | | | CIHE-4, CIHE-6 |
| 25/3-47 | | 3218422 R91 | CIH-3 | 25/34-66 | 25/3218669 | 3218669R91 | CIH-4, CIH-6, |
| 25/3-47A | | 3228663R91 | CIH-3 | | | | CIHE-4, CIHE-6 |
| 25/3-47B | | 3228667R91 | CIH-3 | 25/34-67 | 25/3144977 | 3144977R91 | CIH-4, CIH-6, |
| 25/4-16 | | 796189R1 | CIHE-3 | | | | CIHE-4, CIHE-6 |
| 25/4-17 | | 796202R1 | CIHE-3 | 25/35-42 | 0704092R1 | 704092R1 | CIHE-4, CIHE-5 |
| 25/5-16 | 5-16 | 796190R1 | CIHE-3 | 25/35-44 | 03444481R3 | 3044481R3 | CIHE-4, CIHE-5 |
| 25/5-17 | 5-17 | 796203R1 | CIHE-3 | 25/35-61 | 25/35-61 | 796227R1 | CIHE-4, CIHE-5 |
| 25/6-16 | 6-16 | B616 | CIHE-3 | 25/35-62 | 25/3139587 | 3139587R3 | CIH-4, CIH-5, |
| 25/6-17 | 6-17 | B617 | CIHE-3 | | | | CIHE-4, CIHE-5 |
| 25/9-16 | 25/710327 | 710327 R11 | CIH-3 | 25/35-63 | 25/3139592 | 3139592R4 | CIH-4, CIH-5, |
| 25/11-16 | 03108650R91 | 3108650R91 | CIHE-3 | | | | CIHE-4, CIHE-5 |
| 25/11-17 | 25/11-17 | 3118128R91 | CIHE-3 | 25/35-66 | 25/3144682 | 3144682R3 | CIH-4, CIH-5, |
| 25/11-18 | 25/3228401 | 3228401R91 | CIH-3, CIHE-3 | | | | CIHE-4, CIHE-5 |
| 25/11-19 | 25/3228133 | 3228133R93 | CIH-3, CIHE-3 | 25/35-112 | | | CIH-4 |
| 25/13-14 | 03072092R91 | 3072092R91 | CIHE-3 | 25/38-42 | 0704100R1 | 704100R1 | CIHE-4 |
| 25/13-15 | 25/13-15 | 795662R91 | CIHE-3 | 25/38-62 | 25/3228344 | 3228344R1 | CIH-4, CIHE-4 |
| 25/13-16 | 25/3138701 | 3138701R91 | CIH-3, CIHE-3 | 25/38-63 | 25/3228348 | 3228348R1 | CIH-4, CIHE-4 |
| 25/17-11 | 25/3055215-R1 | 3055215R3 | CIH-3, CIHE-3 | 25/38-112 | | | CIH-4 |
| 25/28-12 | 03043611R1 | 3043611R1 | CIHE-3 | 25/38-113 | | | CIH-4 |
| 25/28-13 | P3113/4123 | 795775R1 | CIHE-3 | 25/41-12 | 0704455R1 | 704455R1 | CIHE-7 |
| 25/28-14 | 03132018R2 | 3132018R2 | CIH-3, CIHE-3 | 25/41-13 | 0704456R2 | 704456R2 | CIHE-7 |
| 25/30-120 | 25/586K3 | | CIH-6, CIHE-6 | 25/41-14 | 03044492R1 | 3044492R1 | CIHE-7 |
| 25/30-121 | 25/586K4 | | CIH-6, CIHE-6 | 25/41-15 | 03044493R2 | 3044493R2 | CIHE-7 |
| 25/30-122 | 25/586K6 | | CIH-6 | 25/41-16 | 25/3055022 | 3055022R1 | CIH-7, CIHE-7 |
| 25/30-123 | 25/591K3 | | CIH-6, CIHE-6 | 25/42-21 | 03040361R1 | 3040361R1 | CIHE-7 |
| 25/30-124 | 25/591K4 | | CIH-6, CIHE-6 | 25/42-22 | 795730R1 | 795730R1 | CIHE-7 |
| 25/30-125 | 25/591K6 | | CIH-6 | 25/42-23 | 25/3055055 | 3055055R2 | CIH-7, CIHE-7 |
| 25/30-126 | 25/516K4 | | CIH-6 | 25/43-21 | 03043825R1 | 3043825R1 | CIHE-7 |
| 25/30-127 | 25/516K6 | | CIH-6 | 25/43-22 | 25/43-22 | 3118132R1 | CIHE-7 |
| 25/30-128 | 25/668K4 | | CIH-6, CIHE-6 | 25/43-23 | 25/3055056 | 3055056R2 | CIH-7, CIHE-7 |
| 25/31-42 | R751604K | 751604R92 | CIHE-4 | 25/44-13 | 03044239R1 | 3044239R1 | CIHE-7 |
| 25/31-44 | R3044479K | 3044479R94 | CIHE-4 | 25/44-14 | 25/44-14 | 3118134R1 | CIHE-7 |
| 25/31-61 | 25/31-61 | B3161 | CIHE-4, CIHE-5 | 25/45-12 | 0710347R2 | 710347R2 | CIHE-7 |
| 25/31-62 | 25/3218758K | 3218758R95 | CIH-4, CIHE-4 | 25/45-13 | 03044240R1 | 3044240R1 | CIHE-7 |
| 25/31-63 | 25/3218759K | 3218759R95 | CIH-4, CIHE-4 | 25/45-14 | 25/45-14 | 3118133R1 | CIHE-7 |
| 25/31-64 | 25/3139586K | 3139586R95 | CIH-4, CIHE-4 | 25/45-15 | 25/3055060 | 3055060R1 | CIH-7, CIHE-7 |
| 25/31-65 | 25/3139591K | 3139591R96 | CIH-4, CIHE-4 | 25/47-5 | 25/47-5 | 3118179R1 | CIHE-7 |
| 25/31-66 | 25/3218668K | 3218668R94 | CIH-4, CIHE-4 | 25/47-6 | 25/3218399 | 3218399R91 | CIH-7, CIHE-7 |
| 25/31-67 | 25/3218461K | 3218461R95 | CIH-4, CIHE-4 | 25/59-8 | | 3138834R1 | CIH-3 |
| 25/31-111 | R111KS | | CIH-4 | 25/60-6 | 03112805R91 | 3112805R91 | CIHE-10 |
| 25/31-112 | R148KS | | CIH-4 | 25/60-8 | 0710348R1 | 710348R1 | CIHE-10 |
| 25/31-113 | 25/3144516K | 3144516R97 | CIH-4 | 25/60-10 | D928523 | K928523 | CIHE-10 |
| 25/31-114 | 25/3218915K | 3218915R95 | CIH-4 | 25/60-13 | R20601 | 0250200021 | CIH-8 |
| 25/31-115 | R099KS | | CIH-4 | 25/60-13 | R20601 | 3054716R91 | CIH-8 |
| 25/32-113 | | | CIH-4 | 25/65-10 | | 3058003R1 | CIH-19 |
| | | | | 25/70-33 | | 3041249R92 | CIHE-8 |

Las referencias originales tienen un propósito identificativo.
Nuestras piezas no son originales.

Part numbers are quoted for reference purposes only.
Our parts and accessories are not original.



LISTA DE REFERENCIAS CRUZADAS (Ref. n°)
CROSS REFERENCES (Order N°)

| REF. n° ORDER N° | REF. ANTIGUA OLD REF. | OEM OEM | PAGINA PAGE | REF. n° ORDER N° | REF. ANTIGUA OLD REF. | OEM OEM | PAGINA PAGE |
|---------------------|--------------------------|------------|-----------------|---------------------|--------------------------|-------------|-----------------|
| 25/71-33 | R706105 | 706105R93 | CIHE-8 | 25/100-35 | 25/100-35 | J928143 | CIH-9 |
| 25/71-47 | 25/71-47 | 3118124R91 | CIHE-8 | 25/101-22 | | 3066610R92 | CIHE-10 |
| 25/71-48 | 25/3136798 | 3136798R99 | CIH-8, CIHE-8 | 25/101-24 | 25/101-24 | 3136002R91 | CIH-9, CIHE-10 |
| 25/71-49 | 25/3136799 | 1967014C1 | CIH-8, CIHE-8 | 25/105-10 | 25/3221253 | 3221253R1 | CIH-12 |
| 25/71-49 | 25/3136799 | 3136799R99 | CIH-8, CIHE-8 | 25/105-11 | R3137474 | 3137474R2 | CIH-12 |
| 25/71-50 | 25/3136801 | 3136801R99 | CIH-8 | 25/107-2 | R9331K | | CIH-24, CIHE-17 |
| 25/71-94 | 25/3051144 | 3051144R92 | CIH-8 | 60/111-2 | 1005 | 704640R91 | CIH-14, CIHE-13 |
| 25/71-100 | 25/71-100 | 3051138R92 | CIH-8 | 60/111-2 | 1005 | 704641R91 | CIH-15 |
| 25/71-101 | 25/71-101 | 3051140R92 | CIH-8 | 60/111-3 | 1087/PK | 1502155C91 | CIH-14, CIHE-13 |
| 25/71-102 | 25/71-102 | 3051142R92 | CIH-8 | 60/111-3 | 1087/PK | 3044506R93 | CIH-14, CIHE-13 |
| 25/71-103 | 25/71-103 | 3051146R92 | CIH-8 | 60/111-3 | 1087/PK | 3144477R92 | CIH-14, CIHE-13 |
| 25/71-95 | 25/3051148 | 3051148R92 | CIH-8 | 60/111-3 | 1087/PK | K960911 | CIH-14, CIHE-13 |
| 25/72-33 | 25/B1036 | B1036 | CIHE-8 | 60/111-16 | 1194F | 3132428R2 | CIH-14, CIHE-13 |
| 25/72-47 | 25/72-47 | 3120516R91 | CIHE-8 | 60/111-16 | 1194F | 31361187R91 | CIHE-13 |
| 25/72-48 | 25/3136802 | 3136802R99 | CIH-8, CIHE-8 | 60/111-16 | 1194F | 3136187R91 | CIH-14, CIHE-13 |
| 25/72-49 | 25/3136813 | 1967011C1 | CIH-8, CIHE-8 | 60/111-16 | 1194F | 3218794R91 | CIH-14, CIHE-13 |
| 25/72-49 | 25/3136813 | 3136813R99 | CIH-8, CIHE-8 | 60/111-25 | 5006F | 3218793R91 | CIH-14, CIHE-13 |
| 25/72-50 | 25/3136817 | 1967013C1 | CIH-8 | 60/111-32 | 1007 | 3056928R1 | CIH-14 |
| 25/72-50 | 25/3136817 | 3136817R99 | CIH-8 | 60/111-32 | 1007 | 715711R91 | CIH-15 |
| 25/73-33 | 0703913R3 | 703883R7 | CIHE-8 | 60/111-32 | 1007 | 716847R91 | CIH-15 |
| 25/73-47 | 25/73-47 | 3118173R1 | CIHE-8 | 60/111-44 | 5007 | A77470 | CIH-14 |
| 25/73-48 | 25/3138959 | 3228361R2 | CIH-8, CIHE-8 | 60/111-44 | 5007 | J903410 | CIH-14 |
| 25/73-49 | 25/3144181 | 3228362R1 | CIH-8 | 60/111-44 | 5007 | J925274 | CIH-14 |
| 25/73-50 | 25/3144182 | 3228019R1 | CIH-8 | 60/111-45 | 5012 | 672603C2 | CIH-14 |
| 25/74-25 | 25/3069767 | 3069767R1 | CIHE-8 | 60/111-45 | 5012 | A184774 | CIH-14 |
| 25/74-26 | 25/74-26 | 3118186R1 | CIHE-8 | 60/111-49 | 9360 | 625627C1 | CIH-14 |
| 25/74-27 | 25/3138641 | 3138641R1 | CIH-8, CIHE-8 | 60/111-49 | 9360 | 702251C1 | CIH-14 |
| 25/74-28 | 25/3138642 | 3138642R2 | CIH-8, CIHE-8 | 60/111-49 | 9360 | A184773 | CIH-14 |
| 25/74-29 | 25/3138688 | 3138688R2 | CIH-8 | 60/111-56 | 1157F | J903640 | CIH-14 |
| 25/75-48 | 25/3218615 | 3055160R3 | CIH-8 | 60/111-64 | F1007 | 712628R91 | CIH-14 |
| 25/75-48 | 25/3218615 | 3218615R91 | CIHE-8 | 25/112-1 | 03069610R1 | 3069610R1 | CIH-14, CIHE-14 |
| 25/75-49 | 25/3055161 | 3055161R91 | CIH-8, CIHE-8 | 25/112-4 | R3144478 | 3144478R1 | CIH-14, CIHE-14 |
| 25/75-50 | 25/3055987 | 3055987R93 | CIH-8 | 25/112-5 | 25/3132197 | 3132197R1 | CIH-14, CIHE-14 |
| 25/75-51 | 25/3144697 | 3144697R2 | CIH-8 | 25/117-51 | 0434250056 | 3040871R91 | CIHE-9 |
| 25/90-35 | 25/3136429R95 | 3136429R95 | CIH-9, CIHE-9 | 25/117-52 | 25/3218251 | 3218251R2 | CIH-10, CIHE-9 |
| 25/90-36 | 25/3136430R95 | 3136430R95 | CIH-9, CIHE-9 | 25/117-53 | 25/3218248 | 3218248R2 | CIH-10, CIHE-9 |
| 25/90-37 | 25/3136431R95 | 3136431R95 | CIH-9, CIHE-9 | 25/117-54 | R178383 | 718383R2 | CIH-10 |
| 25/90-38 | 25/3136432R95 | 3136432R95 | CIH-9 | 25/117-55 | 25/3218249 | 3218249R93 | CIH-10 |
| 25/90-39 | 25/3136433R95 | 3136433R95 | CIH-9 | 25/117-56 | R3055426 | 3055426R91 | CIH-10 |
| 25/90-40 | | J930337 | CIH-9 | 25/117-57 | R3055428 | 3055428R92 | CIH-10 |
| 25/90-41 | | J930338 | CIH-9 | 25/117-58 | 25/3218255 | 3218255R2 | CIH-10 |
| 25/90-43 | | J930336 | CIH-9 | 25/117-59 | 0433171074 | J909476 | CIH-10 |
| 60/96-1 | 111 | 3043283R92 | CIHE-13 | 25/117-60 | 0433171104 | | CIH-10 |
| 60/96-1 | 111 | 3110452R91 | CIHE-13 | 25/117-61 | 0433171121 | | CIH-10 |
| 60/96-5 | 110 | 705735R91 | CIHE-13 | 25/130-25 | R703820 | 3065132R92 | CIHE-11 |
| 60/96-5 | 110 | 705747R91 | CIHE-13 | 25/130-25 | R703820 | 3119778R92 | CIHE-11 |
| 60/96-14 | 143 | 795840R91 | CIH-14 | 25/130-25 | R703820 | 703820R95 | CIHE-11 |
| 60/97-4 | 305/F | 3132022R92 | CIH-14 | 25/130-26 | 25/130-26 | 3118125R91 | CIHE-11 |
| 60/97-4 | 305/F | 3136458R91 | CIH-14 | 25/130-28 | R3132739 | 3132739R93 | CIHE-11 |
| 60/97-9 | 03116609R92 | 3116609R92 | CIHE-13 | 25/130-28 | R3132739 | 3136053R92 | CIHE-11 |
| 60/97-9 | 03116609R92 | 3136046R93 | CIHE-13 | 25/130-29 | R3138936 | 3138936R92 | CIH-11 |
| 60/97-11 | 189(IH) | 3055229R92 | CIH-14 | 25/130-30 | R3132676 | 3132676R93 | CIH-11 |
| 60/97-11 | 189(IH) | 3132023R92 | CIH-14 | 25/130-33 | RR100200 | 789818R91 | CIH-11 |
| 60/97-11 | 189(IH) | 3136459R91 | CIH-14 | 25/130-56 | R718891 | 716410R99 | CIH-11 |
| 60/97-12 | 03132737R93 | 1329020C2 | CIH-14, CIHE-13 | 25/130-56 | R718891 | 718891R97 | CIH-11 |
| 60/97-12 | 03132737R93 | 3132737R93 | CIH-14, CIHE-13 | 25/130-57 | R763613 | 763613R95 | CIH-11 |
| 60/97-12 | 03132737R93 | 3136460R91 | CIH-14 | 25/130-58 | R3136217 | 3132738R93 | CIH-11 |
| 60/97-27 | | 3118119R1 | CIHE-13 | 25/130-58 | R3136217 | 3136217R92 | CIH-11 |
| 60/97-37 | | 398080R2 | CIHE-13 | 25/130-59 | R3132741 | 3132741R93 | CIH-11 |
| 60/97-47 | 2026 | A77537 | CIH-14 | 25/130-60 | 25/3144661 | 3144661R93 | CIH-11 |
| 60/97-51 | 2069 | J903264 | CIH-14 | 25/130-61 | 25/A77703 | A77703 | CIH-11 |
| 60/97-51 | 2069 | J908615 | CIH-14 | 25/130-61 | 25/A77703 | J802358 | CIH-11 |
| 60/97-53 | 2120 | J908616 | CIH-14 | 25/130-62 | 25/A77704 | A77704 | CIH-12 |
| 60/97-74 | 2135 | J919562 | CIH-14 | 25/130-62 | 25/A77704 | J802479 | CIH-12 |
| 25/100-22 | R708294 | 708294R93 | CIHE-10 | 25/131-25 | 131-25 | 1094021R91 | CIHE-11 |
| 25/100-23 | 25/100-23 | 3118234R91 | CIHE-10 | 25/131-26 | 25/131-26 | 3118126R91 | CIHE-11 |
| 25/100-24 | R3132697 | 3132697R92 | CIH-9, CIHE-10 | 25/131-27 | R1094012 | 1094012R91 | CIH-11, CIHE-11 |
| 25/100-24 | R3132697 | B503521 | CIH-9 | 25/131-28 | R3055285KT | 3055285R94 | CIH-11, CIHE-11 |
| 25/100-35 | 25/100-35 | J904374 | CIH-9 | 25/131-56 | R3052183K | 3052183R93 | CIH-11 |
| | | | | 25/133-1 | R322004K | R322004K | CIH-11 |

Las referencias originales tienen un propósito identificativo.
Nuestras piezas no son originales.

Part numbers are quoted for reference purposes only.
Our parts and accessories are not original.



"THE RELIABLE SERVICE"



LISTA DE REFERENCIAS CRUZADAS (Ref. n°)
CROSS REFERENCES (Order N°)

| REF. n° ORDER N° | REF. ANTIGUA OLD REF. | OEM OEM | PAGINA PAGE | REF. n° ORDER N° | REF. ANTIGUA OLD REF. | OEM OEM | PAGINA PAGE |
|---------------------|--------------------------|------------|-----------------|---------------------|--------------------------|------------|------------------|
| 25/141-9 | 141-9 | 3065127R1 | CIHE-11 | 60/162-25 | 2466 | 3153188R1 | CIH-17 |
| 25/142-4 | | 3132144R1 | CIHE-11 | 60/162-25 | 2466 | N8153 | CIH-14 |
| 25/142-5 | 03144028R1 | 3144028R1 | CIHE-11 | 60/162-28 | 067975C1 | 67975C1 | CIH-14 |
| 25/142-6 | 25/3132719 | 3132719R1 | CIH-13, CIHE-11 | 60/162-31 | 9650 | 3219421R1 | CIH-14 |
| 25/142-7 | 25/3132720 | 3132720R1 | CIH-13 | 60/162-65 | 2939 | A47033 | CIH-14 |
| 25/143-15 | 03042303R92 | 3042303R92 | CIHE-11 | 60/162-79 | 25/A171256 | A171256 | CIH-14 |
| 25/143-16 | 25/143-16 | 3118127R1 | CIHE-11 | 25/164-17 | | 3059921R1 | CIH-19 |
| 25/143-17 | R3059676 | 3059676R91 | CIH-12, CIHE-11 | 25/165-30 | 03109792R92 | 3109792R92 | CIHE-15 |
| 25/143-30 | R3055304 | 3055304R92 | CIH-12 | 25/165-31 | R529372 | 529372R1 | CIHE-15 |
| 25/144-11 | 0704449R1 | 704449R1 | CIHE-10 | 25/165-32 | 083027C1 | 83027C1 | CIHE-15 |
| 25/144-23 | 0709502R1 | 709502R1 | CIHE-10 | 25/165-33 | 25/3216683 | 3216683R5 | CIH-19 |
| 25/144-24 | 25/3055715 | 3055715R1 | CIH-12, CIHE-10 | 25/165-34 | 25/3145624 | 3145624R9 | CIH-19 |
| 25/144-25 | 25/3129139 | 3129139R1 | CIHE-10 | 25/165-35 | 25/3404966 | 3404966R4 | CIH-19 |
| 25/144-26 | 25/3129140 | 3129140R1 | CIHE-10 | 25/165-37 | 25/3220369 | 3220369R96 | CIH-19 |
| 25/144-27 | 25/3138935 | 3138935R1 | CIH-12 | 25/165-90 | R704616 | 704616R96 | CIH-19 |
| 25/144-28 | 25/3136258 | 3136258R1 | CIH-12 | 25/165-91 | R3245279 | 3245279 | CIH-19 |
| 25/144-89 | | J911558 | CIH-12 | 25/165-92 | 25/3226762R4 | 3226762R4 | CIH-19 |
| 25/144-90 | | J911562 | CIH-12 | 25/165-102 | | A184460 | CIH-19 |
| 25/149-3 | | 3132718R1 | CIH-14 | 25/165-103 | | A184475 | CIH-19 |
| 25/151-11 | 03111424R91 | 3111424R91 | CIHE-11 | 70/165-400X | TFCM06/0037 | | CIHE-15 |
| 25/151-12 | R532029 | 1500626C91 | CIHE-11 | 70/165-401X | TFCM06/5030 | | CIHE-15 |
| 25/151-12 | R532029 | 532029R1 | CIHE-11 | 25/166-12 | | A189049 | CIH-19 |
| 25/151-13 | 25/3134146 | 3134146R1 | CIH-12 | 25/166-12 | | A189943 | CIH-19 |
| 25/153-24 | | 704289R2 | CIHE-12 | 25/172-16 | 01500494R91 | 1500494C92 | CIHE-16 |
| 25/153-25 | 03042414R1 | 3042414R1 | CIHE-12 | 25/177-20 | 01962381C1 | 1962381C1 | CIHE-17 |
| 25/153-26 | | 3065130R1 | CIHE-12 | 25/177-21 | 01970820C1 | 1970820C1 | CIHE-17 |
| 25/153-27 | 03065129R1 | 3065129R1 | CIHE-12 | 25/177-22 | 01500491C1 | 1500491C1 | CIHE-17 |
| 25/153-28 | 03112067R1 | 3112067R1 | CIHE-12 | 25/177-23 | 01500716C1 | 1500716C1 | CIHE-17 |
| 25/153-29 | 0402191R1 | 402191R1 | CIHE-12 | 25/177-24 | R3058286 | 3058286R93 | CIH-24 |
| 25/153-30 | | 3116665R2 | CIHE-12 | 25/177-24 | R3058286 | 3131889R91 | CIH-24 |
| 25/153-31 | 0402207R1 | 402207R1 | CIHE-12 | 25/177-25 | R3058287 | 3058287R94 | CIH-24 |
| 25/153-32 | 25/3148117 | 3148117R1 | CIH-13 | 25/177-26 | R3229694 | 3229694R2 | CIH-24 |
| 25/153-33 | 25/3134506 | 3134506R1 | CIH-13 | 25/180-7 | 25/3057575 | 3057575R91 | CIH-12, CIHE-8 |
| 25/153-34 | 25/3134507 | 3134507R1 | CIH-13 | 25/180-7 | 25/3057575 | 3127956R1 | CIH-12, CIHE-8 |
| 25/153-35 | 25/3220434 | 3220434R1 | CIH-13 | 25/180-8 | | 963418M1 | CIHE-8 |
| 25/153-90 | 084496C1 | 84496C1 | CIHE-12 | 25/181-17 | 03072947R91 | 3072947R91 | CIHE-16 |
| 25/153-91 | 25/3404225 | 3404225R1 | CIH-13 | 25/181-18 | 03129035R91 | 3129035R1 | CIHE-16 |
| 25/154-26 | | 704287R2 | CIHE-12 | 25/181-19 | R3404170 | 3404170R94 | CIH-20 |
| 25/154-27 | 03044009R1 | 3044009R1 | CIHE-12 | 25/181-22 | 25/1333291 | 1333291C1 | CIH-20 |
| 25/154-29 | 0402189R1 | 402189R1 | CIHE-12 | 25/186-1 | 25/186-1 | | CIHE-8 |
| 25/154-30 | | 3116664R2 | CIHE-12 | 25/186-6 | R3055238 | 3055238R92 | CIH-12, CIHE-8 |
| 25/154-31 | 0402205R1 | 402205R1 | CIHE-12 | 25/186-6 | R3055238 | 376855R92 | CIH-12, CIHE-8 |
| 25/154-32 | 25/3216754 | 3216754R1 | CIH-13 | 25/186-6 | R3055238 | 91450C1 | CIH-12, CIHE-8 |
| 25/154-33 | 25/3399199 | 3399199R1 | CIH-13 | 25/187-4 | 092161C2 | 92161C2 | CIHE-8 |
| 25/154-34 | 25/3057428 | 3057428R1 | CIH-13 | 25/187-5 | 099990C1 | 99990C1 | CIHE-8 |
| 25/154-35 | 25/3220435 | 3220435R1 | CIH-13 | 25/189-202K | ET1400K2 | | CIH-20 |
| 25/154-90 | 084497C1 | 84497C2 | CIHE-12 | 25/200-39 | 0705525R91 | 705525R91 | CIHE-18 |
| 25/154-91 | 25/3226798 | 3226798R1 | CIH-13 | 25/200-40 | 03048528R91 | 3048528R91 | CIHE-19 |
| 60/156-3 | 25/1329039 | 1329039C1 | CIH-14 | 25/200-41 | 03062712R94 | 3062712R94 | CIHE-18 |
| 60/156-3 | 25/1329039 | A151931 | CIH-14 | 25/200-42 | 03048589R91 | 3048589R91 | CIHE-19 |
| 60/156-3 | 25/1329039 | A77544 | CIH-14, CIHE-13 | 25/200-43 | 03067300R92 | 3067300R92 | CIHE-18, CIHE-19 |
| 60/161-15 | 0529854R2 | 529854R2 | CIHE-13 | 25/200-45 | 01500655C91 | 1500655C91 | CIHE-20 |
| 60/161-16 | 03125199R2 | 3125199R2 | CIHE-13 | 25/200-46 | 092603C91 | 92602C91 | CIHE-20 |
| 60/161-17 | 03125342R2 | 3125342R2 | CIHE-13 | 25/200-47 | 1880096206 | 3057150R92 | CIH-26 |
| 60/161-18 | 2452 | 3146927R1 | CIH-14 | 25/200-49 | 1880083111 | 3145303R1 | CIH-27 |
| 60/161-19 | 2467 | 3146576R1 | CIH-14 | 25/200-50 | 0709638R95 | 709638R95 | CIHE-18 |
| 60/161-28 | 067974C4 | 67974C4 | CIH-14 | 25/200-51 | 03047747R93 | 3047747R93 | CIHE-19 |
| 60/161-31 | 2402 | 3219420R1 | CIH-16 | 25/200-53 | 225004411 | 3134875R91 | CIH-25 |
| 60/161-31 | 2402 | 3226416R1 | CIH-14 | 25/200-53 | 225004411 | 3216398R94 | CIH-25 |
| 60/161-35 | 2427 | 3146939R1 | CIH-14 | 25/200-55 | 229000112 | 1964054C1 | CIH-25, CIH-26 |
| 60/161-60 | 2465 | 1105717C1 | CIH-17 | 25/200-55 | 229000112 | 3224545R92 | CIH-25, CIH-26 |
| 60/161-60 | 2465 | 3153187R1 | CIH-17 | 25/200-56 | 230001114 | 1964056C2 | CIH-26 |
| 60/161-60 | 2465 | D56453 | CIH-14 | 25/200-56K | 25/135506A1 | 135506A2 | CIH-26 |
| 60/161-65 | 2935 | A47032 | CIH-14 | 25/200-59 | 228003810 | 3141565R93 | CIH-28 |
| 60/161-79 | 25/A171255 | A171255 | CIH-14 | 25/200-60 | 231002314 | 1964057C1 | CIH-27 |
| 60/162-16 | 03115569R2 | 3115569R2 | CIHE-13 | 25/200-60 | 231002314 | 3220807R94 | CIH-27 |
| 60/162-17 | 03125255R1 | 3125255R1 | CIHE-13 | 25/200-60 | 231002314 | 3234724R93 | CIH-27 |
| 60/162-18 | 9667 | 3148080R1 | CIH-14 | 25/200-110 | 131003810 | 131003810 | CIHE-20 |
| 60/162-19 | 9665 | 3147878R1 | CIH-14 | 25/200-110 | 131003810 | 85025C2 | CIHE-20 |
| 60/162-20 | 9649 | 3216100R1 | CIH-14 | 25/200-111 | 1881089002 | 787513R91 | CIH-25 |

Las referencias originales tienen un propósito identificativo.
Nuestras piezas no son originales.

Part numbers are quoted for reference purposes only.
Our parts and accessories are not original.



LISTA DE REFERENCIAS CRUZADAS (Ref. n°)
CROSS REFERENCES (Order N°)

| REF. n° ORDER N° | REF. ANTIGUA OLD REF. | OEM OEM | PAGINA PAGE | REF. n° ORDER N° | REF. ANTIGUA OLD REF. | OEM OEM | PAGINA PAGE |
|---------------------|--------------------------|----------------|------------------|---------------------|--------------------------|----------------|------------------|
| 25/200-111 | 1881089002 | 787514R91 | CIH-25 | 25/221-110 | 331015410 | 85026C3 | CIHE-20 |
| 25/200-112 | 1881009201 | 3139819R91 | CIH-25 | 25/221-111 | 1861266001 | 787515R91 | CIH-25 |
| 25/200-112 | 1881009201 | 3139821R91 | CIH-25 | 25/221-112 | 1861259101 | 3058676R91 | CIH-25 |
| 25/200-116 | 229000111 | 1964055C1 | CIH-27 | 25/221-112E | R3058676 | 3058676R91 | CIH-25 |
| 25/200-116 | 229000111 | 3404116R91 | CIH-27 | 25/221-113 | R3148964 | 3148964R91 | CIH-25 |
| 25/200-118 | 231002313 | 1964221C1 | CIH-27 | 25/221-114 | 186260101 | 3057151R92 | CIH-26 |
| 25/200-119 | 231000310 | 3146449R97 | CIH-28 | 25/221-114E | R3057151 | 3057151R92 | CIH-26 |
| 25/200-120 | 235000310 | 1964058C2 | CIH-28 | 25/221-115 | R3058405 | 3058405R93 | CIH-26 |
| 25/200-120 | 235000310 | 1964060C2 | CIH-28 | 25/221-116 | 329000111 | 1964154C1 | CIH-27 |
| 25/200-120 | 235000310 | 3220985R98 | CIH-28 | 25/221-117 | R3142099 | 3142099R91 | CIH-27 |
| 25/200-120 | 235000310 | 3226551R98 | CIH-28 | 25/221-119 | 331001110 | 3147053R1 | CIH-28 |
| 25/200-121 | 235000410 | 1964059C1 | CIH-28 | 25/221-120 | 335008010 | 3230720R4 | CIH-28 |
| 25/200-121 | 235000410 | 1964061C1 | CIH-28 | 25/221-121 | 335008110 | 3230726R3 | CIH-28 |
| 25/200-121 | 235000410 | 3226552R98 | CIH-28 | 25/221-122 | 325011330 | 547433R91 | CIH-29 |
| 25/200-121 | 235000410 | 3230986R98 | CIH-28 | 25/221-122 | 325011330 | 785723R91 | CIH-29 |
| 25/200-122 | 125004530 | 544829R91 | CIH-29 | 25/221-123 | 1862001101 | 3054380R91 | CIH-25 |
| 25/200-123 | 125004430 | 60723C1 | CIH-29 | 25/221-178 | | | CIH-25 |
| 25/200-198K | | | CIHE-20 | 25/221-179 | | 1320000200041 | CIH-28 |
| 25/200-199K | | | CIHE-20 | 25/221-180 | | 13200002000031 | CIH-28 |
| 25/200-208K | | | CIHE-20 | 25/221-181 | | 140100160005 | CIH-29 |
| 25/200-308 | | 1984811C1 | CIH-28 | 25/221-182 | | 332123A1 | CIH-29 |
| 25/200-309 | | | CIH-28 | 25/221-183 | | 330732A1 | CIH-29 |
| 25/200-310 | | | CIH-28 | 25/221-184 | | 1987812C1 | CIH-28 |
| 25/200-305 | | 13200002000021 | CIH-28 | 25/221-185 | | | CIH-28 |
| 25/200-306 | | 1401001600041 | CIH-29 | 25/221-186 | | AAU2906 | CIH-28 |
| 25/200-307 | | 223807A1 | CIH-29 | 25/226-4 | | 3129807R92 | CIH-29, CIHE-20 |
| 25/212-11 | 0709640R92 | 709640R92 | CIHE-18, CIHE-19 | 25/227-4 | N7602 | | CIH-29, CIHE-20 |
| 25/212-12 | 323004216 | 3134885R2 | CIH-25 | 25/229-4 | | 80318C91 | CIH-29, CIHE-20 |
| 25/212-12E | R3134885 | 3134885R2 | CIH-25 | 25/230-7 | 0751848R94 | 751848R94 | CIHE-18, CIHE-19 |
| 25/212-13 | R3058404 | 3058404R93 | CIH-26 | 25/230-8 | 069844C91 | 69844C91 | CIHE-20 |
| 25/212-14 | 328015316 | 3141177R91 | CIH-28 | 25/230-9 | 410002600 | 3218393R91 | CIH-25, CIH-26, |
| 25/212-32 | 328002312 | 1964088C1 | CIH-26 | | | | CIH-27, CIH-28 |
| 25/212-33 | 323004211 | 3404117R91 | CIH-27 | 25/230-11 | | 3228525R91 | CIH-27, 28 |
| 25/212-34 | R3141177 | 3141177R91 | CIH-28 | 25/231-9 | 0705542R91 | 705542R91 | CIHE-18, CIHE-19 |
| 25/212-35 | 331007317 | 1964222C2 | CIH-27 | 25/231-10 | 03070635R91 | 3070635R91 | CIHE-18, CIHE-19 |
| 25/212-36 | 331007311 | 1964089C1 | CIH-27 | 25/231-11 | 085104C1 | 85104C92 | CIHE-20 |
| 25/212-37 | 331001211 | 3147057R91 | CIH-28 | 25/231-12 | 25/786532 | 786532R91 | CIH-25 |
| 25/212-38 | 335007911 | 1964090C1 | CIH-28 | 25/231-13 | 25/3147877 | 3147877R91 | CIH-26, CIH-27, |
| 25/212-39 | | | CIH-28 | | | | CIH-28 |
| 25/212-162 | | 132000020005 | CIH-28 | 25/231-14 | 25/3142880 | 3142880R91 | CIH-25, CIH-26, |
| 25/212-163 | | 140100160006 | CIH-29 | | | | CIH-27, CIH-28 |
| 25/221-39 | 03040412R91 | 3040412R91 | CIHE-18 | 25/231-15 | 25/3136858 | 3136858R11 | CIH-25, CIH-26 |
| 25/221-40 | 03048529R91 | 3048529R91 | CIHE-19 | 25/231-46 | 25/786533 | | CIH-25 |
| 25/221-41 | 03062713R91 | 3062713R91 | CIHE-18 | 25/231-142 | | 1966557C1 | CIH-28 |
| 25/221-42 | 03048590R91 | 3048590R91 | CIHE-19 | 25/231-143 | | 1966618C1 | CIH-28 |
| 25/221-43 | 03074827R91 | 3074827R91 | CIHE-18, CIHE-19 | 25/231-144 | | | CIH-28 |
| 25/221-44 | 03121506R92 | 3121506R92 | CIHE-20 | 25/240-35 | | 3140498R91 | CIH-18 |
| 25/221-45 | 03121507R92 | 3121507R92 | CIHE-20 | 25/240-35 | | 3217969R1 | CIH-18 |
| 25/221-46 | 03129834R1 | 3129834R1 | CIHE-20 | 25/240-35 | | 3229787R1 | CIH-18 |
| 25/221-47 | 1861331106 | 3059214R94 | CIH-26 | 25/240-17 | R/G250068 | 3134665R91 | CIH-30 |
| 25/221-47E | R3059214 | 3059214R94 | CIH-26 | 25/240-17 | R/G250068 | 3229907R1 | CIH-30 |
| 25/221-48 | 1861450001 | 3142128R91 | CIH-27 | 60/240-42 | 0530144R92 | 133736C1 | CIH-14 |
| 25/221-50 | 0709639R94 | 709639R94 | CIHE-18 | 60/240-42 | 0530144R92 | 530144R92 | CIH-14, CIHE-13 |
| 25/221-51 | 03108790R91 | 3108790R91 | CIHE-19 | 60/240-43 | 25/1328276 | 1328276C1 | CIH-14 |
| 25/221-51E | 25/3108790 | 3108790R91 | CIHE-19 | 60/240-44 | 25/3405722 | 3224623R1 | CIH-14 |
| 25/221-53 | 325010016 | 3225978R93 | CIH-25 | 60/240-44 | 25/3405722 | 3405722R2 | CIH-14 |
| 25/221-53E | R3225978 | 3225978R93 | CIH-25 | 60/240-46 | R3147441 | 3147441R92 | CIH-14 |
| 25/221-54E | R3216397 | 3216397R91 | CIH-25 | 60/240-70 | 51759 | 1976934C4 | CIH-14 |
| 25/221-55 | 329000116 | 3224546R92 | CIH-26, CIH-27 | 25/303-30 | | 226823A1 | CIH-31 |
| 25/221-55E | 25/3224546 | 3224546R92 | CIH-26, CIH-27 | 25/303-30 | | 1995034C1 | CIH-31 |
| 25/221-56 | R3137677 | 3137677R3 | CIH-26 | 25/309-4 | 0534936R93 | 534936R93 | CIHE-28 |
| 25/221-57 | R3225950 | 3225950R1 | CIH-26 | 25/309-5 | 0534934R1 | 534934R92 | CIHE-28 |
| 25/221-58 | 330001512 | 3225094R3 | CIH-26 | 25/309-6 | 03125257R91 | 3125257R91 | CIHE-28 |
| 25/221-58E | R3225094E | 3225094R3 | CIH-26 | 25/309-7 | 066193C1 | 66193C91 | CIHE-28 |
| 25/221-59 | 328010710 | 3141567R93 | CIH-28 | 25/324-4 | 0401992R3 | 1971050C1 | CIHE-17 |
| 25/221-59E | R3141185 | 3141185 | CIH-28 | 25/371-10 | 0703915R1 | 703915R1 | CIHE-29 |
| 25/221-59E | R3141567 | 3141567R93 | CIH-28 | 25/371-11 | 03069987R91 | 3069987R91 | CIHE-29 |
| 25/221-60 | 331007511 | 3224423R93 | CIH-27 | 25/371-12 | 0105470C1 | 105470C1 | CIHE-29 |
| 25/221-60E | 25/3224423 | 3224423R93 | CIH-27 | 25/371-13 | 0105471C1 | 105471C1 | CIHE-29 |
| 25/221-110 | 331015410 | 331015410 | CIHE-20 | 25/371-14 | 25/7131172 | 7131172R1 | CIH-31 |

Las referencias originales tienen un propósito identificativo.
Nuestras piezas no son originales.

Part numbers are quoted for reference purposes only.
Our parts and accessories are not original.



"THE RELIABLE SERVICE"



LISTA DE REFERENCIAS CRUZADAS (Ref. n°)
CROSS REFERENCES (Order N°)

| REF. n° ORDER N° | REF. ANTIGUA OLD REF. | OEM OEM | PAGINA PAGE | REF. n° ORDER N° | REF. ANTIGUA OLD REF. | OEM OEM | PAGINA PAGE |
|---------------------|--------------------------|------------|-----------------|---------------------|--------------------------|------------|-----------------|
| 25/371-15 | 25/711199 | 711199R1 | CIH-31 | 25/451-5 | 0369857R1 | 369857R1 | CIHE-23 |
| 25/371-16 | 25/3145061 | 3145061R91 | CIH-31 | 25/451-6 | 067537C1 | 67537C1 | CIHE-23 |
| 25/371-17 | 25/3220032 | 3220032R91 | CIH-31 | 25/452-1 | R427639 | 427639R1 | CIH-33, CIHE-23 |
| 25/372-12 | 25/3114947 | 3114947R91 | CIH-31, CIHE-29 | 25/452-6 | | 427639R1 | CIH-33, CIHE-23 |
| 25/372-13 | 03114946R91 | 3114946R91 | CIHE-29 | 70/457-2 | LN10-2 | | CIH-35, CIHE-29 |
| 25/372-14 | 03106877R91 | 3106877R91 | CIHE-29 | 70/457-5 | LN10-5 | 427645R1 | CIH-33 |
| 25/372-15 | 25/3216105 | 3216105R91 | CIH-31 | 70/457-5 | LN10-5 | | CIH-35 |
| 25/372-16 | 0102160H | 102160H | CIHE-29 | 25/460-13 | R1094017 | 1094017R92 | CIHE-23 |
| 25/372-17 | 0298188R91 | 298188R91 | CIHE-29 | 25/460-14 | R1094015 | 1094015R92 | CIHE-23 |
| 25/372-18 | 0384695R91 | 384695R91 | CIHE-29 | 25/460-18 | R1094034 | 1094034R93 | CIHE-23 |
| 25/372-19 | 0972467R91 | 972467R91 | CIHE-29 | 25/460-19 | 25/B1040 | B1040 | CIH-33 |
| 25/372-20 | 25/712794 | 712794R91 | CIH-31 | 25/460-19 | | B1040 | CIH-33 |
| 25/372-21 | 25/ST273A | ST273A | CIH-31 | 25/460-20 | | 2221K | CIH-33 |
| 25/372-22 | 25/3134990 | 3134990R91 | CIH-31 | 25/460-21 | | 2222K | CIH-33 |
| 25/372-23 | 25/3220034 | 3220034R93 | CIH-31 | 25/460-22 | | 2223K | CIH-33 |
| 25/376-7 | 0380200R92 | 380200R92 | CIHE-29 | 25/460-23 | 25/B1044 | B1044 | CIH-33 |
| 25/376-8 | 0530102R91 | 530102R91 | CIHE-29 | 25/460-23 | | B1044 | CIH-33 |
| 25/385-3 | 0703913R3 | 703913R3 | CIHE-29 | 25/461-13 | 461-13 | 704083R92 | CIHE-23 |
| 25/385-4 | 0399762R3 | 399762R3 | CIHE-29 | 25/461-14 | 461-14 | 530104R91 | CIHE-23 |
| 25/385-5 | 25/711193 | 711193R1 | CIH-31 | 25/461-17 | 461-17 | 50259D | CIHE-23 |
| 25/409-15 | 01500021C1 | 1500021C1 | CIHE-17 | 25/461-18 | 461-18 | 370254R91 | CIHE-23 |
| 25/410-12 | | 1287734C92 | CIH-30, CIHE-21 | 25/461-19 | 25/3057057 | 3057057R91 | CIH-33 |
| 25/410-13 | | 3129643R91 | CIH-30, CIHE-21 | 25/461-20 | 25/3131386 | 3131386R1 | CIH-33 |
| 25/410-14 | | 527542R92 | CIHE-21 | 25/461-22 | 25/3131013 | 3131013R1 | CIH-33 |
| 25/410-15 | | 1287843C92 | CIH-30, CIHE-21 | 25/461-23 | 25/3232807 | 3232807R1 | CIH-33 |
| 25/410-16 | | 1971138C1 | CIHE-21 | 25/462-13 | 25/462-13 | 618022R91 | CIH-33, CIHE-23 |
| 25/411-12 | | 1288229C1 | CIH-30, CIHE-21 | 25/462-18 | 462-18 | 400989C91 | CIHE-23 |
| 25/411-13 | | 1288228C1 | CIH-30, CIHE-21 | 25/462-19 | 25/663556 | 663556R91 | CIH-33 |
| 25/411-14 | | 3125824R1 | CIHE-21 | 25/462-23 | 25/462-23 | 3232808R91 | CIH-33 |
| 25/417-1 | | 787004R22 | CIH-30 | 25/463-13 | 463-13 | 3043872R91 | CIHE-23 |
| 25/417-16 | 25/3134664 | 3134664R91 | CIHE-21 | 25/463-14 | | 371881R91 | CIHE-23 |
| 25/417-16 | | 786460R21 | CIH-30, CIHE-21 | 25/463-18 | 463-18 | 536052R91 | CIHE-23 |
| 25/417-20 | | 3142883R94 | CIH-30 | 25/463-19 | 25/463-19 | 3142103R91 | CIH-33 |
| 25/420-5 | 25/3145546 | 3145546R92 | CIH-30 | 25/463-20 | R629790 | 3142105R91 | CIH-33 |
| 25/420-6 | 0114622C2 | 114622C2 | CIHE-21 | 25/463-22 | 25/463-22 | 3229813R91 | CIH-33 |
| 25/420-7 | 25/3220450 | 3220450R94 | CIH-30 | 25/463-23 | 25/463-23 | 3232820R91 | CIH-33 |
| 25/420-15 | 0704422R93 | 704422R93 | CIHE-21 | 25/464-1 | 48548D | | CIHE-23 |
| 25/420-16 | R/G250069 | 3064170R91 | CIH-30, CIHE-21 | 25/464-2 | | 406295R2 | CIHE-23 |
| 25/421-15 | R3134668K | 3134668R3 | CIH-30 | 25/464-3 | | 67328C1 | CIHE-23 |
| 25/421-15 | R3134668K | 751761R92 | CIH-30, CIHE-21 | 25/464-4 | 25/3131014 | 3131014R1 | CIH-33 |
| 25/421-16 | R357111K | 3040152R92 | CIH-30, CIHE-21 | 25/464-5 | 25/464-5 | 3232806R1 | CIH-33 |
| 25/421-17 | R3134496K | 3069460R91 | CIH-30 | 25/470-66 | 03121261R91 | 3121261R91 | CIHE-22 |
| 25/421-17 | R3134496K | 3134496R91 | CIH-30 | 25/470-67 | 03121270R91 | 3121270R91 | CIHE-22 |
| 25/440-6 | 03047576R2 | 3047576R2 | CIHE-26 | 25/470-68 | 0405840R12 | 405840R12 | CIHE-22 |
| 25/440-7 | 0404341R3 | 404341R3 | CIHE-26 | 25/470-69 | 0527292R92 | 527292R92 | CIHE-22 |
| 25/440-8 | R3058254 | 3058254R1 | CIH-37 | 25/470-70 | 067526C91 | 67526C91 | CIHE-22 |
| 25/440-9 | 25/3399467 | 3399467R1 | CIH-37 | 25/470-71 | 067535C91 | 67535C91 | CIHE-22 |
| 25/440-10 | 25/3220372 | 3220372R2 | CIH-37 | 25/470-75 | R3405599 | 3140078R94 | CIH-32 |
| 25/441-7 | 03047575R2 | 3047575R2 | CIHE-26 | 25/470-75 | R3405599 | 3146322R95 | CIH-32 |
| 25/441-8 | 25/905514 | 905514R1 | CIH-37 | 25/470-75 | R3405599 | 3230079R1 | CIH-32 |
| 25/441-8 | 25/905514 | 98782C1 | CIH-37 | 25/470-75 | R3405599 | 3405599R1 | CIH-32 |
| 25/441-9 | | 3230348R2 | CIH-37 | 25/470-75 | R3405599 | 3405601R1 | CIH-32 |
| 25/441-10 | 25/3230784 | 3230784R1 | CIH-37 | 25/470-76 | R3405615 | 3140076R93 | CIH-32 |
| 25/441-11 | 441-11 | 3230875R2 | CIH-37 | 25/470-76 | R3405615 | 3146320R95 | CIH-32 |
| 25/441-14 | R933602 | 933602R1 | CIH-37 | 25/470-76 | R3405615 | 3230092R1 | CIH-32 |
| 25/441-15 | R934008 | 934008R1 | CIH-37 | 25/470-76 | R3405615 | 3405613R1 | CIH-32 |
| 25/442-2 | 0703929R1 | 703929R1 | CIHE-26 | 25/470-76 | R3405615 | 3405615R1 | CIH-32 |
| 25/442-3 | 0406951R2 | 406951R2 | CIHE-26 | 25/470-77 | R3405619 | 3141509R93 | CIH-32 |
| 25/443-3 | 0406953R1 | 406953R1 | CIHE-26 | 25/470-77 | R3405619 | 3230097R1 | CIH-32 |
| 25/446-9 | 03047573R1 | 3047573R1 | CIHE-23 | 25/470-77 | R3405619 | 3405617R1 | CIH-32 |
| 25/446-10 | 0528803R1 | 528803R1 | CIHE-23 | 25/470-77 | R3405619 | 3405619R1 | CIH-32 |
| 25/446-11 | R3137538 | 3137538R2 | CIH-33 | 25/470-77 | R3405619 | 3405619R1 | CIH-32 |
| 25/446-15 | R785612 | 785612R1 | CIH-33 | 25/471-75 | R3405600 | 3140079R94 | CIH-32 |
| 25/447-4 | 0483879R2 | 483879R2 | CIHE-23 | 25/471-75 | R3405600 | 3146323R95 | CIH-32 |
| 25/447-5 | R933948 | 933948R1 | CIH-33 | 25/471-75 | R3405600 | 3230080R1 | CIH-32 |
| 25/449-11 | 0704675R1 | 704675R91 | CIHE-24 | 25/471-75 | R3405600 | 3405600R1 | CIH-32 |
| 25/449-12 | 03114166R91 | 3114166R91 | CIHE-24 | 25/471-75 | R3405600 | 3405602R1 | CIH-32 |
| 25/449-13 | 03121425R91 | 3121425R91 | CIHE-24 | 25/471-76 | R3405614 | 3140077R93 | CIH-32 |
| 25/450-19 | R3131012 | 3131012R31 | CIH-33 | 25/471-76 | R3405614 | 3146321R95 | CIH-32 |
| 25/450-20 | 25/3229812 | 3229812R1 | CIH-33 | 25/471-76 | R3405614 | 3230093R1 | CIH-32 |

Las referencias originales tienen un propósito identificativo.
Nuestras piezas no son originales.

Part numbers are quoted for reference purposes only.
Our parts and accessories are not original.



LISTA DE REFERENCIAS CRUZADAS (Ref. n°)
CROSS REFERENCES (Order N°)

| REF. n° ORDER N° | REF. ANTIGUA OLD REF. | OEM OEM | PAGINA PAGE | REF. n° ORDER N° | REF. ANTIGUA OLD REF. | OEM OEM | PAGINA PAGE |
|---------------------|--------------------------|------------|-----------------|---------------------|--------------------------|------------|---------------------------|
| 25/471-76 | R3405614 | 3405614R1 | CIH-32 | 25/497-12 | R3058214 | 3058214R91 | CIH-39 |
| 25/471-76 | R3405614 | 3405616R1 | CIH-32 | 25/497-13 | 25/3148926 | 3148926R1 | CIH-39, CIH-40, CIH-41 |
| 25/471-77 | R3405618 | 3141510R93 | CIH-32 | 25/497-14 | 25/3223997 | 3223997R1 | CIH-39, CIH-40, CIH-41 |
| 25/471-77 | R3405618 | 3230098R1 | CIH-32 | 25/497-15 | 25/3232877 | 3232877R92 | CIH-40, CIH-41 |
| 25/471-77 | R3405618 | 3405618R1 | CIH-32 | 25/497-17 | 25/497-17 | N14377 | CIH-41 |
| 25/471-77 | R3405618 | 3405620R1 | CIH-32 | 25/497-21 | 25/3217279 | 3217279R1 | CIH-42 |
| 25/471-77 | R3405618 | 6405618R1 | CIH-32 | 25/497-22 | 25/3230364 | 3230364R1 | CIH-42 |
| 25/475-16 | B1265 | | CIHE-22 | 25/497-23 | R3146733 | 3146733R1 | CIH-42 |
| 25/475-17 | B1266 | | CIHE-22 | 25/497-24 | R3140943 | 3140943 R1 | CIH-42 |
| 25/475-18 | B1267 | | CIH-32 | 25/497-44 | 25/497-44 | N14388 | CIH-41 |
| 25/475-19 | B1268 | | CIH-32 | 25/497-60 | R1968463C1 | 1968463C1 | CIH-41, CIHE-27 |
| 25/475-20 | B1269 | | CIH-32 | 25/514-25 | | 3057159R92 | CIH-36 |
| 25/475-21 | B1270 | | CIH-32 | 25/530-25 | | 3058222R92 | CIH-36 |
| 25/475-21 | B1270 | | CIH-32 | 25/535-25 | | 3058229R92 | CIH-36 |
| 25/475-48 | B1267 | | CIH-32 | 69/565-4 | R3145248 | 3142097R91 | CIH-43 |
| 25/476-12 | 476-12 | 15943DA | CIHE-22 | 69/565-4 | R3145248 | 3145248R93 | CIH-43 |
| 25/476-13 | 25/3131033 | 3131033R1 | CIH-32 | 69/565-8 | 25/3147535BX | 3147535R92 | CIH-43 |
| 25/476-14 | R323813 | 3232813R1 | CIH-32 | 69/565-8 | R3147535 | 3147535R94 | CIH-43 |
| 25/477-13 | 40090D | | CIHE-22 | 69/565-8 | R3147535 | 3216613R91 | CIH-43 |
| 25/477-14 | 477-14 | 376099R1 | CIHE-22 | 69/565-19 | R3054300 | 3054300R93 | CIH-43 |
| 25/477-15 | 25/3059475 | 3059475R91 | CIH-32 | 69/565-20 | R3148938 | 3142096R91 | CIH-43 |
| 25/477-16 | 25/3057051 | 3057051R1 | CIH-32 | 69/565-20 | R3148938 | 3148938R92 | CIH-43 |
| 25/477-17 | 25/3232821R1 | 3232821R1 | CIH-32 | 69/565-21 | R3145619 | 3142563R91 | CIH-43 |
| 25/479-13 | 479-13 | 3070055R91 | CIHE-22 | 69/565-21 | R3145619 | 3145619R92 | CIH-43 |
| 25/479-14 | 479-14 | 527295R91 | CIHE-22 | 69/565-22 | R1328655 | 1328655C91 | CIH-43 |
| 25/479-15 | 25/3057058 | 3057058R91 | CIH-32 | 69/565-22 | R1328655 | 1986961C1 | CIH-43 |
| 25/479-16 | 25/3142132 | 3142132R1 | CIH-32 | 69/565-23 | R3401189 | 3401189R94 | CIH-43 |
| 25/479-17 | 25/479-17 | 3233850R91 | CIH-32 | 69/565-24 | R3146446 | 3146446R93 | CIH-44 |
| 25/480-17 | 25/3141506 | 3141506R2 | CIH-32 | 69/565-24 | R3146446 | 3146450R91 | CIH-44 |
| 25/480-18 | 25/3224268 | 3224268R3 | CIH-32 | 69/565-25 | R3223932 | 3223932R94 | CIH-44 |
| 25/483-3 | 0405584R2 | 405584R2 | CIHE-24 | 69/565-27 | R089880C1 | 89880C91 | CIH-44 |
| 25/484-3 | 0405576R1 | 405576R1 | CIHE-24 | 69/565-28 | R3220221 | 3220221R93 | CIH-44 |
| 25/485-21 | 25/3140082 | 3140082R1 | CIH-36 | 69/565-29 | R3226942 | 3226942R93 | CIH-44 |
| 25/485-22 | 25/3232823 | 3232823R1 | CIH-36 | 69/566-4 | 25/3145248BX | 3142097R91 | CIH-43 |
| 25/486-14 | 0405570R1 | 405570R1 | CIHE-24 | 69/566-4 | 25/3145248BX | 3145248R93 | CIH-43 |
| 25/486-25 | 25/3057064 | 3057064R1 | CIH-36 | 69/566-8 | 25/3147535BX | 3147535R92 | CIH-43 |
| 25/486-26 | 25/3134952 | 3134952R1 | CIH-36 | 69/566-8 | R3147535 | 3216613R91 | CIH-43 |
| 25/486-27 | 25/3232822 | 3232822R1 | CIH-36 | 69/566-23 | 25/3401189BX | 3401189R94 | CIH-43 |
| 25/491-14 | 25/3045309 | 3040921R11 | CIHE-27 | 69/566-25 | 25/3223932BX | 3223932R92 | CIH-43 |
| 25/491-14 | 25/3045309 | 3045309R91 | CIHE-27 | 69/566-28 | 25/3220221BX | 3220221R93 | CIH-44 |
| 25/491-15 | R3058208 | 3058208R91 | CIH-39 | 69/567-25 | | | CIH-44 |
| 25/491-16 | R3058210 | 3058210R91 | CIH-39 | 69/567-29 | | | CIH-44 |
| 25/491-17 | 25/3148925 | 3148925R1 | CIH-39 | 25/572-1 | 0405580R11 | 405580R11 | CIHE-24 |
| 25/491-18 | 25/3147525 | 3147525R1 | CIH-39 | 25/581-3 | 25/3059432 | 3059432R1 | CIH-40 |
| 25/491-22 | R3131021 | 3131021R2 | CIH-39 | 25/581-4 | 25/3059433 | 3059433R1 | CIH-40 |
| 25/492-14 | 25/3040922 | 3040922R92 | CIHE-27 | 25/581-5 | R3141530 | 3141530R91 | CIH-40, CIH-41 |
| 25/492-16 | R3058207 | 3058207R92 | CIH-39 | 25/581-6 | R3141532 | 3141532R93 | CIH-40, CIH-41 |
| 25/492-17 | 25/3147510 | 3147510R1 | CIH-39 | 25/581-7 | R3141529 | 3141529R91 | CIH-42, CIHE-27 |
| 25/492-22 | R3131016 | 3131016R1 | CIH-39 | 25/581-8 | R3141531 | 3141531R91 | CIH-42 |
| 25/495-20 | 25/3040919 | 3040919R92 | CIHE-27 | 25/581-9 | 25/3221931 | 3221931R91 | CIH-42 |
| 25/495-21 | R3116406 | 3116406R2 | CIHE-27 | 25/581-10 | 25/3221932 | 3221932R92 | CIH-42 |
| 25/495-21 | R3116406 | 3116406R3 | CIHE-27 | 25/581-11 | 25/3224265 | 3224265R1 | CIH-40, CIH-41 |
| 25/495-22 | 25/3125171 | 3125171R1 | CIHE-27 | 25/581-11 | 25/3230099 | 3230099R1 | CIH-40 |
| 25/495-23 | R3058213 | 3058213R91 | CIH-39 | 25/581-12 | 25/3224266 | 3224266R92 | CIH-40, CIH-41 |
| 25/495-24 | 25/3148923 | 3148923R1 | CIH-39 | 25/581-14 | R3146035 | 3146035R92 | CIH-42 |
| 25/495-25 | R3401843 | 3401843R1 | CIH-39 | 25/581-16 | 25/3233186 | 3233186R91 | CIH-40, CIH-41 |
| 25/495-26 | 25/3217563 | 3217563R1 | CIH-40 | 25/581-17 | R3221270 | 3221270R91 | CIH-42 |
| 25/495-27 | 25/3223995 | 3223995R1 | CIH-39 | 25/581-18 | R3221271 | 3221271R93 | CIH-42 |
| 25/495-28 | 25/3223996 | 3223996R1 | CIH-40 | 25/583-1 | 0379748R1 | 379748R1 | CIHE-24 |
| 25/495-29 | 25/3148929 | 3148929R1 | CIH-41 | 25/584-1 | 0405574R1 | 405574R1 | CIHE-24 |
| 25/495-60 | R1968464C1 | 1968464C1 | CIH-41, CIHE-27 | 25/640-15 | 093835C92 | 93835C92 | CIHE-28 |
| 25/495-67 | 25/495-67 | 126144A1 | CIH-41 | 25/640-26 | 0704330R95 | 704330R95 | CIHE-28 |
| 25/495-68 | 25/495-68 | 126145A1 | CIH-41 | 60/641-16 | 25/1971728 | 1971728C1 | CIH-14 |
| 25/495-70 | R716195 | 716195R91 | CIH-39 | 25/702-8 | R447 | | CIH-46 |
| 25/495-70 | R716195 | 717678R91 | CIH-39 | 25/703-8 | R448 | | CIH-46 |
| 25/496-14 | 25/3040920 | 3040920R92 | CIHE-27 | 25/704-11 | R3137660 | 3137660R1 | CIH-47, CIHE-31 |
| 25/497-11 | R3116407 | 3116407R2 | CIHE-27 | 25/704-12 | R528084 | 3074756R1 | CIHE-31 |
| 25/497-11 | R3116407 | 3116407R3 | CIHE-27 | 25/704-12 | R528084 | 528084R1 | CIH-47, CIHE-31 |

Las referencias originales tienen un propósito identificativo.
Nuestras piezas no son originales.

Part numbers are quoted for reference purposes only.
Our parts and accessories are not original.



LISTA DE REFERENCIAS CRUZADAS (Ref. n°)
CROSS REFERENCES (Order N°)

| REF. n° ORDER N° | REF. ANTIGUA OLD REF. | OEM OEM | PAGINA PAGE | REF. n° ORDER N° | REF. ANTIGUA OLD REF. | OEM OEM | PAGINA PAGE |
|---------------------|--------------------------|-----------------|-----------------|---------------------|--------------------------|-------------|----------------|
| 25/704-13 | R528081 | 528081R1 | CIH-47, CIHE-31 | 62/910-2 | LU227115 | 3112883R91 | CIHE-32 |
| 68/715-6 | AT38/26 | | CIH-47 | 62/911-2 | 54E213/780 | UWB102 | CIHE-32 |
| 68/715-7 | AT28/25 | | CIH-47 | 62/913-2 | 227E541 | USB104 | CIHE-32 |
| 68/715-8 | AT28/96 | | CIH-47 | 62/913-5 | 258/01026 | 1107014144 | CIH-48 |
| 25/719-5 | 25/3057362 | 3057362R1 | CIH-47, CIHE-31 | 62/914-1 | 227E818 | UTB110 | CIHE-32 |
| 25/719-6 | 25/3057361 | 3057361R1 | CIH-47, CIHE-31 | 62/915-1 | 189E237 | UTB107 | CIHE-32 |
| 25/740-16 | R2999K | | CIHE-31 | 62/919-1 | 37LU229 | 708969R92 | CIHE-32 |
| 68/740-17 | AT6410KP | | CIH-47 | 62/919-2 | 37RB408 | K908901 | CIHE-32 |
| 25/740-18 | | 3146371R94 | CIH-47 | 62/919-13 | 205/01007 | 0192052005 | CIH-48 |
| 25/740-20 | 25/3140173 | 1965995C91 | CIH-47 | 62/919-15 | 205/01001 | 0190601006 | CIH-48 |
| 25/743-8 | R3140005 | 3140005R1 | CIH-47 | 62/919-17 | 205/04034 | 205/04034 | CIHE-32 |
| 25/743-8 | 25/3145157 | 3145157R1 | CIH-47 | 62/919-20 | 505E079 | | CIH-48 |
| 25/743-8 | 25/3146371 | 3146371 | CIH-47 | 62/919-21 | 205/05122 | | CIH-48 |
| 25/743-9K | R3220670K | 3220670R2 | CIH-46, CIH-47 | 62/919-80 | 37UCB612 | UCB100 | CIHE-32 |
| 25/744-7 | 25/3140173 | 3140173R2 | CIH-47 | 62/919-81 | 37UCB584 | UCB109 | CIHE-32 |
| 25/746-7 | 25/3140714 | 3140174R2 | CIH-47 | 62/920-4 | 03125132R92 | 3125132R92 | CIHE-32 |
| 25/747-4 | 25/3146372 | 3146372R92 | CIH-47 | 62/920-10 | 15/1276 | 3129851R91 | CIHE-32 |
| 25/748-2 | 25/3226000 | 3141246 | CIH-47 | 62/920-10 | 15/1276 | 92292C1 | CIHE-32 |
| 25/748-2 | 25/3226000 | 3226000R1 | CIH-47 | 62/920-23 | K552 | 3218239R91 | CIH-48 |
| 25/755-20 | 0527937R1 | 527937R1 | CIHE-30 | 62/920-38 | 15/1116 | 3218577R91 | CIH-48 |
| 25/758-7 | 25/1532287 | 1532287C1 | CIH-46 | 62/920-34 | 15/5599 | | CIH-48 |
| 25/759-20 | 0527967R91 | 527967R91 | CIHE-30 | 62/920-62 | 15/1133 | | CIH-48 |
| 25/759-21 | 0527940R91 | 527940R91 | CIHE-30 | 62/920-64 | 15/1215 | 3218544R91 | CIH-48 |
| 25/759-22 | 0527948R91 | 527948R91 | CIHE-30 | 62/920-65 | 15/1230 | | CIH-48 |
| 25/760-25 | R443 | CIH-46, CIHE-30 | | 62/920-71 | 15/1675 | 11201675 | CIH-48 |
| 25/760-26 | R443B | CIHE-30 | | 62/920-72 | 15/1953 | A187873 | CIH-48 |
| 25/760-27 | R436 | CIHE-30 | | 62/920-76 | 15/8999 | A187623 | CIH-48 |
| 25/760-28 | R436B | CIH-46, CIHE-30 | | 62/920-84 | 510E249 | 432988A | CIH-48 |
| 25/760-31K | R445K | CIH-46 | | 62/923-1 | 54E219/368 | ULB110 | CIHE-32 |
| 25/760-32 | R438 | CIH-46 | | 62/923-5 | 258/01073 | 1127014011 | CIH-48 |
| 25/760-33 | R444K | CIH-46 | | 62/930-7 | 15/00208IH | 3046890R91 | CIHE-33 |
| 25/761-20 | 069991C91 | 69991C91 | CIHE-30 | 62/930-13 | R537140 | 537140R92 | CIHE-33 |
| 25/761-21 | 069992C91 | 69992C91 | CIHE-30 | 62/930-13 | R537140 | K529965 | CIHE-33 |
| 25/761-22 | 069993C91 | 69993C91 | CIHE-30 | 62/930-21 | 15/00506IH | 3228192R91 | CIH-49 |
| 25/761-23 | 03116725R91 | 3116725R91 | CIHE-30 | 62/930-22 | R3055414 | 3228193R91 | CIH-49 |
| 25/762-20 | 03121964R1 | 3121964R1 | CIH-46, CIHE-30 | 62/930-43 | | 13200009075 | CIH-49 |
| 25/762-21 | 03121965R1 | 3121965R1 | CIH-46, CIHE-30 | 62/930-52 | 15/30412 | 114799A1 | CIH-49 |
| 25/762-22 | R446 | CIH-46 | | 62/930-52 | 15/30412 | A187597 | CIH-49 |
| 25/770-3 | HYSE-314 | CIH-45 | | 62/930-54 | 15/00704 | 3228193R91 | CIH-49 |
| 25/770-4 | HYSE-314XL | CIH-45 | | 62/930-55 | 15/00705 | 3228192R91 | CIH-49 |
| 25/772-3 | HYSE-315 | CIH-45 | | 62/931-3 | 54E251/818 | 3047395R91 | CIHE-33 |
| 61/830-520 | 6/856KAB-AC | CIH-54 | | 62/931-5 | 54E247/379 | 3129384R1 | CIHE-33 |
| 61/830-845 | SG10/UAC | CIHE-35 | | 62/931-8 | 03113038R91 | 3113038R91 | CIHE-33 |
| 25/870-9 | 25/1284636 | 1284636C2 | CIH-52 | 62/931-10 | 54E268/555 | 84059C1 | CIHE-33 |
| 25/870-10 | 25/3221531 | 3221531R1 | CIH-52 | 62/931-12 | 220/01055A | 2004004112 | CIH-50 |
| 25/870-11 | 25/3225465 | 3225465R2 | CIH-52 | 62/931-17 | 220/01001 | 2004004044 | CIH-50 |
| 25/870-12 | 03118430R1 | 3118430R1 | CIHE-35 | 62/932-3 | 272E394 | 3062381R91 | CIHE-33 |
| 25/870-13 | 03123040R1 | 3123040R1 | CIHE-35 | 62/932-4 | 54E244/973 | 3206527R91 | CIHE-33 |
| 25/870-14 | 03125425R1 | 3125425R1 | CIHE-35 | 62/932-7 | 54E268/462 | 84058C1 | CIHE-33 |
| 25/870-15 | 25/3234163 | 3234163R1 | CIH-52, CIHE-35 | 62/933-2 | 271E735 | 705833R91 | CIHE-33 |
| 25/870-31 | | 1971235C2 | CIH-52 | 62/933-3 | 54E259/517 | 3118371R91 | CIHE-33 |
| 25/870-32 | | 1343825C1 | CIH-52 | 62/933-8 | 258/01056B | 2007014052 | CIH-50 |
| 25/870-33 | 25/71-33+25/72-33 | 189447A2 | CIH-52 | 62/933-17 | 258/01059 | 2007014057 | CIH-50 |
| 25/870-34 | | 199976066 | CIH-52 | 62/933-18 | 258/01057 | 2007014056 | CIH-50 |
| 25/870-35 | | 144947A2 | CIHE-35 | 62/934-1 | 54E243/853 | 3113029R91 | CIHE-33 |
| 25/870-36 | 25/3148826 | 3148826R2 | CIH-52 | 62/939-5 | 292E124 | 3117750R91 | CIHE-33 |
| 25/871-8 | 25/3221572 | 3221572R1 | CIH-52 | 62/939-8 | 03114822R91 | 3114822R91 | CIHE-33 |
| 25/871-9 | 25/3399042 | 3399042R1 | CIH-52 | 62/939-13 | 03113033R91 | 3113033R91 | CIHE-33 |
| 25/871-10 | 03123835R1 | 3123835R1 | CIHE-35 | 62/939-16 | 54E268/142 | 84209C2 | CIHE-33 |
| 25/871-11 | 25/3399422 | 3399422R3 | CIH-52, CIHE-35 | 62/939-28 | 224/01061 | 2006209301 | CIH-50 |
| 25/872-11 | 25/1284622 | 1284622C2 | CIH-52 | 62/939-29 | 224/01126 | 2006209436 | CIH-50 |
| 25/872-12 | 25/3232760 | 3232760R2 | CIH-52 | 62/939-30 | 224/01150 | 2006209304 | CIH-50 |
| 25/872-14 | 25/3232937 | 3232937R1 | CIH-52, CIHE-35 | 62/939-32 | 224/01058 | 2006209302 | CIH-50 |
| 25/872-21 | | 1280263C1 | CIH-52 | 62/939-35 | 224/01134 | 2006209303 | CIH-50 |
| 25/872-22 | | 1332420C1 | CIH-52, CIHE-35 | 62/940-4 | LU76703 | 3109131R91 | CIHE-33 |
| 25/876-1 | | 1531489C1 | CIH-52 | 62/940-5 | LU76458 | 3062380R91 | CIHE-33 |
| 25/876-2 | | 1531490C1 | CIH-52 | 62/940-7 | LU76796 | 3111040R91 | CIHE-33 |
| 69/905-5 | HPF8/T | 313163R91 | CIH-45 | 62/940-11 | 03124479R93 | 3124479R93 | CIHE-33 |
| 69/906-5 | HPF8/R | 737606R1 | CIH-45 | 62/940-13 | LU77036 | 84060C1 | CIHE-33 |
| 62/910-1 | LU22703/N | 3055228R91 | CIHE-32 | 62/940-18 | 203/01056R | 0331401001 | CIH-50 |

Las referencias originales tienen un propósito identificativo.
Nuestras piezas no son originales.

Part numbers are quoted for reference purposes only.
Our parts and accessories are not original.



LISTA DE REFERENCIAS CRUZADAS (Ref. n°)
CROSS REFERENCES (Order N°)

| REF. n° ORDER N° | REF. ANTIGUA OLD REF. | OEM OEM | PAGINA PAGE | REF. n° ORDER N° | REF. ANTIGUA OLD REF. | OEM OEM | PAGINA PAGE |
|---------------------|--------------------------|------------|----------------|---------------------|--------------------------|------------|------------------|
| 62/940-19 | 203/01070 | 0331401004 | CIH-50 | 63/1955-245 | 10/12814 | H40556 | CIH-20 |
| 62/940-27 | 203/01049 | 0331401008 | CIH-50 | 63/1955-265 | 10/12866 | | CIH-22 |
| 62/940-28 | 203/01065 | 0331401003 | CIH-50 | 63/1955-380 | 10/12500 | 3131234R1 | CIH-20 |
| 62/940-29 | 203/01069 | 0331401002 | CIH-50 | 63/1955-382 | 10/12498 | 1094366R1 | CIH-20 |
| 63/950-2 | R3119716 | 3119716R91 | CIHE-17 | 63/1955-382 | 10/12498 | 3131227R1 | CIH-20 |
| 25/950-11 | 10/343B | 3057998R91 | CIH-23 | 63/1955-410 | 10/12620 | 3076115R1 | CIH-20 |
| 25/950-16 | R3399520 | 1532371C1 | CIH-23 | 63/1955-453 | 10/12336 | | CIH-22, CIHE-16 |
| 25/950-16 | R3399520 | 3399520R1 | CIH-23 | 63/1955-460 | 10/13336 | | CIH-22, CIHE-16 |
| 25/950-17 | R3405762 | 1532372C1 | CIH-23 | 63/1955-472 | 10/12342 | | CIH-20 |
| 25/950-17 | R3405762 | 3221154R91 | CIH-23 | 25/1970-3 | 25/1533899 | 1533899 C1 | CIH-23 |
| 25/950-17 | R3405762 | 3405762R1 | CIH-23 | 25/1970-4 | 25/1964583 | 1964853C1 | CIH-23 |
| 25/950-18 | R3136852 | 3136852R1 | CIH-22 | 25/1971-3 | 25/1533880 | 1533880C1 | CIH-23 |
| 25/958-1 | 25/3057633 | 3057633R91 | CIH-23 | 25/1971-4 | 25/1964989 | 1964989 C1 | CIH-23 |
| 25/958-2 | R3399522 | 3399522R2 | CIH-23 | 63/1980-2 | 10/112-85 | | CIHE-36 |
| 25/961-2 | 25/3142068R5 | 3142068R5 | CIH-24 | 63/1980-3 | 10/112-110 | | CIHE-36 |
| 25/961-3 | 25/3131226 | 3131226R91 | CIH-24 | 63/1980-4 | ET623045 | | CIH-53 |
| 25/1101-12K | R3141807K | 3141807R92 | CIH-47 | 63/1980-5 | ET113/12 | | CIH-53 |
| 25/1127-40 | R449 | | CIH-46 | 70/1987-9 | 10/3223 | 3113077R1 | CIH-53, CIHE-36 |
| 25/1912-24 | R843K | | CIH-21 | 70/1987-18 | 10/3225 | 3113942R1 | CIH-53, CIHE-36 |
| 25/1912-25 | 25/3057566 | 3057566R91 | CIH-21 | 70/1987-20 | 10/3227 | 3234746R91 | CIH-53, CIHE-36 |
| 25/1912-25 | ET047/022 | | CIH-21 | 70/1987-22 | 10/3229 | | CIH-53 |
| 25/1912-26 | 25/3057567 | 3057567R91 | CIH-21 | 70/1987-25 | 70/1987-25 | 3401303R91 | CIH-53, CIHE-36 |
| 25/1912-26 | ET047/025 | | CIH-21 | 25/1988-1 | | 1974779C1 | CIH-53, CIHE-36 |
| 25/1912-27 | 25/3145942 | 3145942R91 | CIH-21 | 25/2830-150 | 0117997 | 117997 | CIHE-22 |
| 25/1912-28 | 25/3145943 | 3145943R91 | CIH-21 | 70/2930-45 | 5870/10 | | CIH-19 |
| 25/1912-29 | 25/3223263 | 3223263R91 | CIH-21 | 70/2930-51 | 5870/21 | | CIH-19, CIHE-15 |
| 25/1912-30 | 25/3223264 | 3223264R91 | CIH-21 | 70/2930-57 | 5870/22 | | CIH-19 |
| 25/1912-31 | 25/3148492 | 3148492R91 | CIH-21 | 70/2930-64 | 5870/23 | | CIH-19, CIHE-15 |
| 25/1912-32 | 25/3221209 | 3221209R92 | CIH-21 | 70/2935-54 | MC5856 | | CIH-19, CIHE-15 |
| 25/1912-33 | 25/3221210 | 3221210R92 | CIH-21 | 70/2935-64 | MC5865 | | CIH-19, CIHE-15 |
| 25/1913-20 | ET047/026 | | CIH-21 | 25/4000-35 | D7000 | 3113554R1 | CIHE-37 |
| 25/1913-21 | R3058245 | 3058245R91 | CIH-21 | 25/4000-36 | D7010 | 3233045R1 | CIH-55, CIHE-38, |
| 25/1913-27 | 25/3145945 | 3145945R1 | CIH-21 | | | | CIHE-39 |
| 25/1913-28 | 25/3145946 | 3145946R1 | CIH-21 | 25/4000-45 | D7060 | 1535093C2 | CIH-56 |
| 25/1913-29 | 25/3226117 | 3226117R1 | CIH-21 | 25/4000-48 | D7090 | 144768A1 | CIHE-40 |
| 25/1913-30 | 25/3226118 | 3226118R1 | CIH-21 | 25/4002-2 | D7040 | 3125386R1 | CIHE-41 |
| 25/1913-31 | R3148499 | 3148499 R1 | CIH-21 | 25/4004-1 | D7091 | 144986A1 | CIHE-40 |
| 25/1913-32 | 25/3224286 | 3224286R1 | CIH-21 | 25/4004-3 | D7091/A | 234969A1 | CIHE-40 |
| 25/1913-33 | 25/3224287 | 3224287R1 | CIH-21 | 25/4011-8 | D7072 | 1330877C1 | CIH-57 |
| 25/1918-3 | R3121089 | 3121089R91 | CIH-20 | 25/4011-9 | D7073 | 1330876C1 | CIH-57 |
| 25/1918-7 | R82364C1 | 82364C1 | CIH-20 | 25/4012-24 | D7001 | 3113558R1 | CIHE-37 |
| 25/1918-8 | R82363C1 | 82363C1 | CIH-20 | 25/4012-29 | D7061 | 1535088C1 | CIH-56 |
| 25/1918-9 | 25/3057564 | 3057564R91 | CIH-20 | 25/4012-32 | D7092 | 144730A1 | CIHE-40 |
| 25/1918-9 | 25/3226119 | 3226119R1 | CIH-20 | 25/4015-2 | D7042 | 3125387R1 | CIHE-41 |
| 25/1918-10 | 25/3226120 | 3226120R1 | CIH-20 | 25/4016-2 | D7041 | 3125388R1 | CIHE-41 |
| 25/1918-11 | 25/3221211 | 3221211R91 | CIH-20 | 25/4020-11 | D7002 | 1500610C2 | CIHE-37 |
| 63/1918-16 | ET420 | | CIH-22 | 25/4020-12 | D7008 | 3114017R1 | CIHE-37 |
| 25/1918-20 | 25/3057565 | 3057565R91 | CIH-20 | 25/4020-21 | D7098 | 1975195C1 | CIHE-39 |
| 25/1919-3 | 25/3148501 | 3148501R1 | CIH-20 | 25/4021-22 | D7063 | 1535114C1 | CIH-56 |
| 25/1919-7 | R90308C1 | 90308C1 | CIH-20 | 25/4022-22 | D7062 | 1535113C1 | CIH-56 |
| 25/1919-8 | R90309C1 | 90309C1 | CIH-20 | 25/4025-4 | D7083 | 1999626C2 | CIH-57 |
| 25/1919-9 | R3059187 | 3059187R1 | CIH-20 | 25/4026-2 | D7013 | 3233053R1 | CIH-55, CIHE-38, |
| 25/1919-10 | R3058242 | 3058242R91 | CIH-20 | | | | CIHE-39 |
| 25/1919-11 | R3224290 | 3224290R1 | CIH-20 | 25/4027-2 | D7014 | 3233051R1 | CIH-55, CIHE-38, |
| 25/1920-2 | 25/3053400 | 3053400R92 | CIH-24 | | | | CIHE-39 |
| 63/1920-6 | 63/1920-6 | 3231505R91 | CIH-21 | 25/4029-4 | D7084 | 1999625C2 | CIH-57 |
| 63/1931-2 | 1931-2 | | CIHE-16 | 25/4034-1 | D7043 | 3125458R1 | CIHE-41 |
| 63/1931-3 | ET5171 | | CIH-22 | 25/4035-1 | D7044 | 3125457R1 | CIHE-41 |
| 63/1931-4 | ET1253/F | | CIH-22 | 25/4036-1 | D7045 | 3125460R1 | CIHE-41 |
| 63/1931-5 | 10/W394 | | CIH-22 | 25/4037-1 | D7046 | 3125459R1 | CIHE-41 |
| 63/1931-6 | ET1251/H | | CIHE-16 | 25/4038-7 | D7074 | 1330930C1 | CIH-57 |
| 63/1931-7 | ET1181/F | | CIHE-16 | 25/4038-8 | D7075 | 1546817C2 | CIH-57 |
| 63/1931-8 | 10/752M | | CIHE-16 | 25/4039-7 | D7076 | 1330931C1 | CIH-57 |
| 63/1931-9 | ET421/H3 | | CIH-22 | 25/4039-8 | D7077 | 1546818C2 | CIH-57 |
| 63/1934-5 | ET131 | | CIH-22 | 25/4040-3 | D7048/S | 3125391R1 | CIHE-41 |
| 63/1955-207 | 10/12821 | 1094368R1 | CIH-20 | 25/4041-5 | D7048/F | 3125392R1 | CIHE-41 |
| 63/1955-207 | 10/12821 | 711335R1 | CIH-20 | 25/4047-12 | D7003 | 3123655R1 | CIHE-37 |
| 63/1955-239 | 10/12844 | 710196R1 | CIH-20 | 25/4047-13 | D7006 | 1328550C1 | CIHE-37 |
| 63/1955-245 | 10/12814 | 3051192R1 | CIH-20 | 25/4047-28 | D7093 | 144759A1 | CIHE-40 |
| | | | | 25/4047-34 | D7078 | 1330903C1 | CIH-57 |

Las referencias originales tienen un propósito identificativo.
Nuestras piezas no son originales.

Part numbers are quoted for reference purposes only.
Our parts and accessories are not original.



"THE RELIABLE SERVICE"



LISTA DE REFERENCIAS CRUZADAS (Ref. n°)
CROSS REFERENCES (Order N°)

| REF. n° ORDER N° | REF. ANTIGUA OLD REF. | OEM OEM | PAGINA PAGE | REF. n° ORDER N° | REF. ANTIGUA OLD REF. | OEM OEM | PAGINA PAGE |
|---------------------|--------------------------|------------|-----------------------------|---------------------|--------------------------|------------|-----------------|
| 25/4047-35 | D7079 | 1330902C1 | CIH-57 | 25/6403-18 | R3224325 | 3148651R1 | CIH-37, CIHE-26 |
| 25/4072-22 | D6772 | 3125412R1 | CIHE-41 | 25/6403-18 | R3224325 | 3224325R1 | CIH-37, CIHE-26 |
| 25/4072-24 | D7017 | 3233046R3 | CIH-55, CIHE-38, CIHE-39 | 25/6403-19 | R3224326 | 3217467R1 | CIH-37, CIHE-26 |
| 25/4072-25 | D7012 | 3226351R3 | CIH-55, CIHE-38 | 25/6403-19 | R3224326 | 3224326R1 | CIHE-26 |
| 25/4072-30 | D7004 | 98604C2 | CIHE-37 | 25/6403-20 | 25/965165#& | K965215 | CIH-37, CIHE-26 |
| 25/4072-32 | D7064 | 1535079C1 | CIH-56 | 25/6404-1 | | 1342710C1 | CIH-34, CIHE-25 |
| 25/4072-33 | D7099 | 126317A1 | CIHE-39 | 25/6405-1 | | 1342713C1 | CIH-34, CIHE-25 |
| 25/4072-36 | D7094 | 144794A1 | CIHE-40 | 25/6405-2 | | 1342712C1 | CIH-34, CIHE-25 |
| 25/4072-40 | D7081 | 1330904C1 | CIH-57 | 25/6405-8 | | 1342717C1 | CIH-34, CIHE-25 |
| 25/4072-41 | D7080 | 127442A1 | CIH-57 | 25/6405-9 | | 1342716C1 | CIH-34, CIHE-25 |
| 25/4073-12 | D7005 | 3118657R1 | CIHE-37 | 25/6406-1 | | 81453C1 | CIHE-25 |
| 25/4073-13 | D7007 | 1328504C1 | CIHE-37 | 25/6406-2 | | 81683C1 | CIH-34 |
| 25/4073-14 | D7018 | 3233032R1 | CIH-55, CIHE-38, CIHE-39 | 25/6406-8 | | 81435C1 | CIH-34, CIHE-25 |
| 25/4073-15 | D7019 | 1500941C1 | CIH-55, CIHE-38, CIHE-39 | 25/6406-9 | | 81320C1 | CIH-34, CIHE-25 |
| 25/4073-21 | D7065 | 1535071C1 | CIH-56 | 25/6407-5 | | 81288C2 | CIH-34, CIHE-25 |
| 25/4073-22 | D7095 | 144731A1 | CIHE-40 | 25/6407-6 | | 81411C2 | CIH-34, CIHE-25 |
| 25/4073-36 | D7082 | 1981934C1 | CIH-57 | 25/6407-7 | | 1964235C1 | CIH-34, CIHE-25 |
| 25/4074-3 | D7050/S | 3125395R1 | CIHE-41 | 25/6410-8 | | 81312C2 | CIH-34, CIHE-25 |
| 25/4075-3 | D7050/F | 3125396R1 | CIHE-41 | 25/6410-9 | | 81676C1 | CIH-34 |
| 25/4085-1 | D7015 | 3233040R1 | CIH-55, CIHE-38, CIHE-39 | 25/6430-3 | | 81452C1 | CIHE-25 |
| 25/4086-1 | D7016 | 3233041R1 | CIH-55, CIHE-38, CIHE-39 | 25/6430-4 | | 81319C1 | CIH-34, CIHE-25 |
| 25/4110-9 | 13/1200 | | CIH-54, CIHE-36 | 25/6430-10 | | 81434C1 | CIH-34, CIHE-25 |
| 25/4110-10 | 13/1206 | | CIH-54, CIHE-36 | 25/6431-4 | | 81455C1 | CIHE-25 |
| 25/4110-11 | 13/1207 | | CIH-54, CIHE-36 | 25/6431-5 | | 81688C1 | CIH-34 |
| 25/4110-12 | 13/1208 | | CIH-54, CIHE-36 | 25/6431-8 | | 81325C1 | CIH-34, CIHE-25 |
| 25/4110-13 | 13/1209 | | CIH-54, CIHE-36 | 25/6450-1 | | 81428C1 | CIH-34, CIHE-25 |
| 25/4111-4 | 13/1201 | | CIH-54, CIHE-36 | 25/6450-3 | | 81305C1 | CIH-34, CIHE-25 |
| 25/4112-2 | 13/1202 | | CIH-54, CIHE-36 | 25/6462-2 | | 81429C2 | CIH-34, CIHE-25 |
| 25/4112-3 | 13/1203 | | CIH-54, CIHE-36 | 25/6462-8 | | 81306C2 | CIH-34, CIHE-25 |
| 25/4112-4 | 13/1204 | | CIH-54, CIHE-36 | 25/6490-2 | 25/6490-2 | | CIH-35 |
| 25/4112-5 | 13/1205 | | CIH-54, CIHE-36 | 25/6490-3 | 25/6490-3 | | CIH-35 |
| 25/4012-23 | | 3233036R1 | CIHE-38 | 25/6490-1K | 25/101K | | CIH-35, CIHE-27 |
| 25/4170-18 | 6734 | | CIH-51 | 25/6491-6 | | 3221117R91 | CIH-35 |
| 25/4170-25 | 13/1443 | | CIHE-34 | 25/6491-7 | | 3221116R91 | CIH-35 |
| 25/4170-26 | 03112460R91 | 3112460R91 | CIHE-34 | 25/6491-8 | | 3230179R91 | CIH-35 |
| 25/4170-27 | 03112461R91 | 3112461R91 | CIHE-34 | 25/6491-9 | | 3223350R91 | CIH-35 |
| 25/4170-28 | 01328552C1 | 1328552C1 | CIHE-34 | 25/6491-10 | | 3223354R92 | CIH-35 |
| 25/4170-29 | 01328553C1 | 1328553C1 | CIHE-34 | 25/6491-11 | | 3148646R92 | CIH-35 |
| 25/4170-30 | 13/1417 | 13/1417 | CIHE-34 | 25/6491-12 | | 3148647R92 | CIH-35 |
| 25/4170-31 | 13/1414 | 3113466R91 | CIHE-34 | 25/6500-102 | DA102 | | CIH-36 |
| 25/4170-32 | 6066 | | CIH-51 | 25/6500-103 | DA103 | | CIH-36 |
| 25/4170-33 | 6065 | | CIH-51 | 25/6500-104 | DA104 | | CIH-36 |
| 25/4172-25 | ET642 | 3118074R91 | CIHE-35 | 25/6500-105 | DA105 | | CIH-36 |
| 25/4172-26 | 10/6218E | 3118077R91 | CIHE-35 | 25/6500-106M | DA106M | | CIH-36 |
| 25/4172-27 | 10/5417 | 3399576R91 | CIH-51 | 25/6500-106T | DA106T | | CIH-36 |
| 60/4200-2 | 60/4200-1 | 3233584R2 | CIH-14, CIHE-14 | 25/6500-107 | DA107 | | CIH-36 |
| 25/6050-1 | | 3132717R1 | CIH-14 | 25/7600-5 | HB47/SA | 3058344R91 | CIH-45 |
| 25/6050-2 | | 3218257R1 | CIH-14 | 69/7600-6 | HB47/SAC | 3054388R91 | CIH-45 |
| 25/6050-2 | | 3218330R1 | CIH-14 | 69/7600-7 | HB47/DA | 3059907R91 | CIH-45 |
| 25/6400-4 | | 81413C1 | CIH-34, CIHE-25 | 25/7600-8 | HSV10 | | CIH-45 |
| 25/6400-5 | | 81414C1 | CIH-34, CIHE-25 | 25/7600-11 | | | CIH-45 |
| 25/6400-9 | | 81291C1 | CIH-34, CIHE-25 | 25/7600-13 | | | CIH-45 |
| 25/6400-10 | | 81292C1 | CIH-34, CIHE-25 | 69/7600-15 | | | CIH-45 |
| 25/6401-3 | | 81687C1 | CIH-34 | 25/7608-1 | HB47/EN | | CIH-45 |
| 25/6403-7 | R3230277 | 3230277R1 | CIH-37, CIHE-26 | 25/7608-2 | HB47/ENE | | CIH-45 |
| 25/6403-8 | 25/1342719 | 1342719C1 | CIHE-26 | 69/7609-1 | HB47/SACPO | 3225760R1 | CIH-45 |
| 25/6403-8 | 25/1342719 | 3216691R1 | CIH-37, CIHE-26 | 25/7609-2 | H158L | | CIH-45 |
| 25/6403-9 | | 1342705C1 | CIH-37, CIHE-26 | 25/7610-1 | HB47/RP | | CIH-45 |
| 25/6403-10 | R3133521 | 3133521R1 | CIH-37 | 69/7611-1 | BH704-104 | 3140895R92 | CIH-45 |
| 25/6403-13 | | 100546A1 | CIH-37, CIHE-26 | 69/7611-1 | BH704-104 | 3147440R91 | CIH-45 |
| 25/6403-14 | | 1342711C1 | CIH-37, CIHE-26 | 69/7611-5 | BH704116 | 89845C91 | CIH-45 |
| 25/6403-15 | | 1342708C1 | CIH-37, CIHE-26 | 25/7612-1 | H148A | | CIH-45 |
| 25/6403-16 | 25/1975562C1 | 1975562C1 | CIH-37, CIHE-26 | | | | |
| 25/6403-17 | | 3223955R1 | CIH-37, CIHE-26 | | | | |

Las referencias originales tienen un propósito identificativo.
Nuestras piezas no son originales.

Part numbers are quoted for reference purposes only.
Our parts and accessories are not original.



- © **Copyright TRACPIECES 2000.** *Reproduction, même partielle, interdite sans autorisation. Les erreurs ou omissions qui auraient pu se glisser dans ce catalogue malgré le soin apporté à sa réalisation n'engagent pas la responsabilité de Bepco-Tracpièces Group.*
- © **Copyright TRACPIECES 2000.** *Reproduction or partial reproduction is forbidden without authorisation. Whilst every effort has been made to ensure the accuracy of the information provided The Bepco-Tracpièces Group declines responsibility for any errors or omissions included in this publication.*
- © **Copyright TRACPIECES 2000.** *Nachdruck, auch nur auszugsweise, nur mit schriftlicher Genehmigung. Für eventuelle Druckfehler in diesem Katalog übernimmt die Bepco-Tracpièces Group keine Haftung. Irrtümer vorbehalten. Warenabgabe nur solange Vorrat reicht.*
- © **Copyright TRACPIECES 2000.** *Reproductie, nog copieren van gedeeltes, verboden zonder toelating. De fouten of vergeten gegevens die zich in de catalogus bevinden, ondanks deze zeer goed is samengesteld, heeft dit geen verbintenis met de verantwoordelijkheid van Bepco-Tracpièces Group.*

**A leading worldwide brand in
agricultural tractor parts and
accessories since 1958.**

**Bepco-Tracpièces Group is your
guarantee in quality, service and
competitive pricing.**

Quality is...



"THE RELIABLE SERVICE"



TRACPIÈCES